

# Radio-Electronics

JUNE

TELEVISION • SERVICING • HIGH FIDELITY

HUGO GERNSBACK, Editor

**Build:**

**3-Way Electronic Crossover**

**Improved Capacitance Meter**

**Servicing Wireless Intercoms**

## The Story of Relays

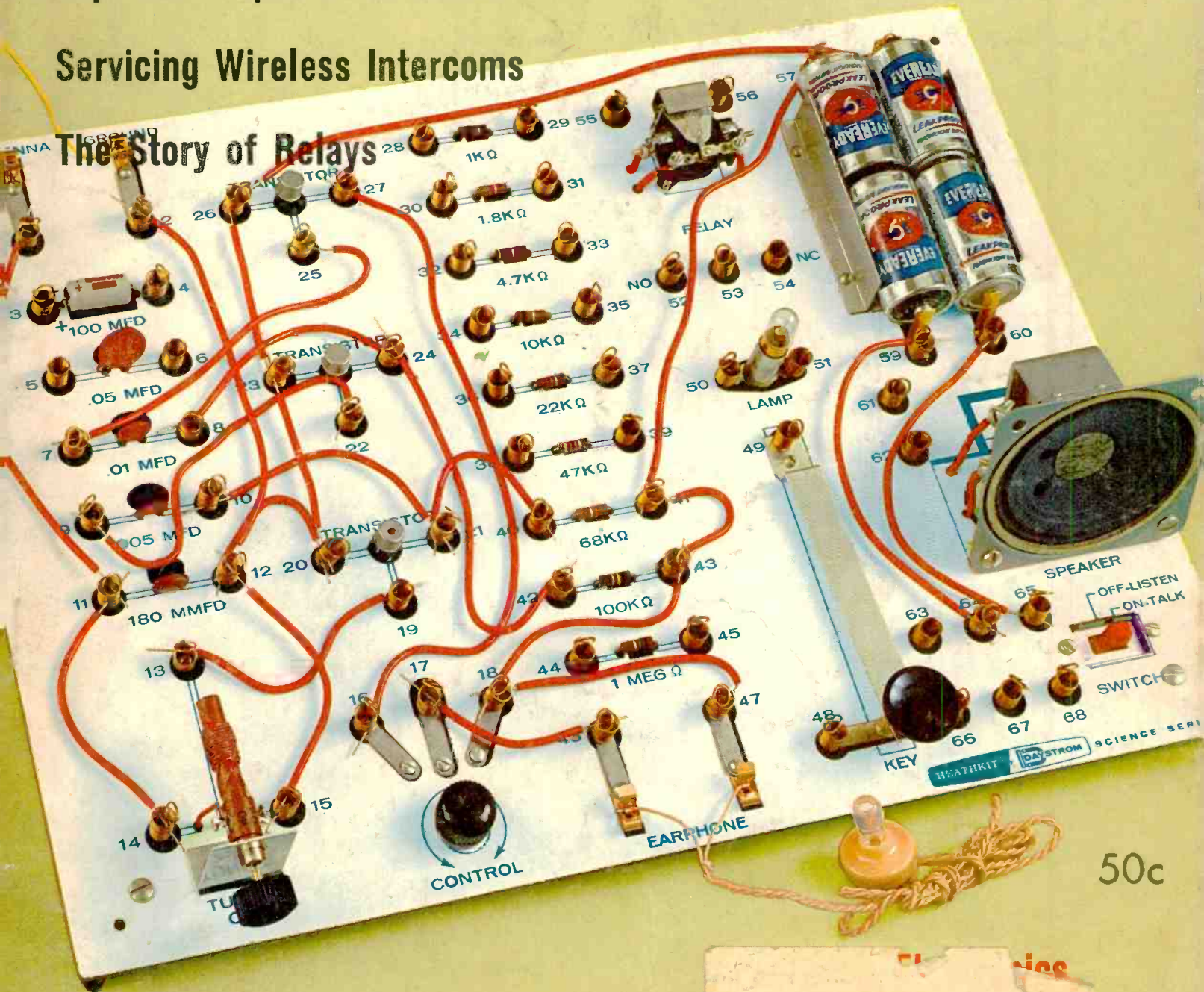

50c

W P SMITH 9-61  
4934 CLAXTON  
LOUIS 20 MISSOURI

# TRIPLETT

# ACTUAL SIZE

## USES UNLIMITED:

- Field Engineers
- Application Engineers
- Electrical, Radio, TV, and Appliance Servicemen
- Electrical Contractors
- Factory Maintenance Men
- Electronic Technicians
- Home Owners, Hobbyists



## MODEL 310

complete  
**VOLT-OHM-MILLIAMMETER**



## World's Largest Selling **POCKET SIZE V-O-M**

### FEATURES:

- 1** Hand size and lightweight, but with the features of a full-size V-O-M.
- 2** 20,000 ohms per volt DC; 5,000 AC.
- 3** EXCLUSIVE SINGLE SELECTOR SWITCH speeds circuit and range settings. The first miniature V-O-M with this exclusive feature for quick, fool-proof selection of all ranges.

SELF-SHIELDED Bar-Ring instrument; permits checking in strong magnetic fields • Fitting interchangeable test prod tip into top of tester makes it the common probe, thereby freeing one hand • UNBREAKABLE plastic meter window • BANANA-TYPE JACKS—positive connection and long life.

■ Price—only **\$34.50**; leather case **\$3.20**.

Available For Immediate Delivery From Your Triplet Distributor's Stock



## MODEL 100

The most comprehensive test set in the Triplet line is Model 100 V-O-M Clamp-On-Ammeter Kit, now available at distributors. The world's most versatile instrument—a complete accurate V-O-M plus a clamp-on-ammeter with which you can take measurements without stripping the wires. Handsome, triple-purpose carton holds and displays all the components: Model 100 miniaturized V-O-M, Model 10 Clamp-On-Ammeter, Model 101 Line Separator, No. 311 Extension leads, and a leather carrying case, which neatly accommodates all the components. Model 101 literally makes it possible to separate the two sides of the line when using Model 10. Extension leads permit use of Model 10 at a distance from the V-O-M. Complete Model 100 is only **\$59.50**

**THE TRIPPLETT ELECTRICAL INSTRUMENT COMPANY, BLUFFTON, OHIO**

MANUFACTURERS OF PANEL AND PORTABLE INSTRUMENTS; ELECTRICAL AND ELECTRONIC TEST EQUIPMENT

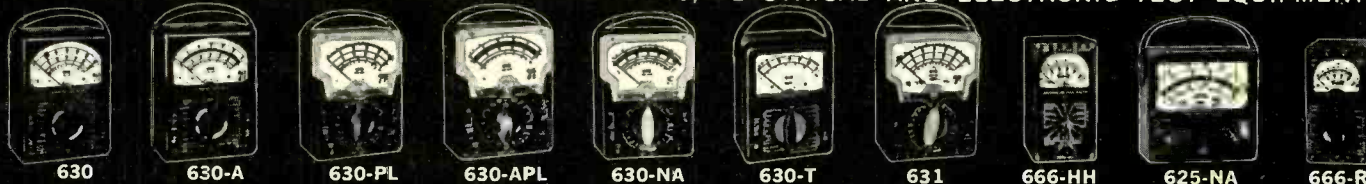

**FOR EVERY PURPOSE—THE WORLD'S MOST COMPLETE LINE OF V-O-M'S**

# NOW READY

# The NEW NRI Home Study Course in ELECTRONICS

PRINCIPLES — PRACTICES — MAINTENANCE

## SPECIAL TRAINING EQUIPMENT

No extra cost. In NRI Electronics training especially developed training kits bring to life theory you learn in easy, illustrated lessons. You get practical experience with Thyatron Tube circuits, Multivibrators, Capacitors, Diodes, Transistors, Telemetry, Computer Circuits and other basic circuits and components.



**KIT 1** Get practical experience measuring voltage, current, building circuits.

**KIT 2** Build d'Arsonval type Vacuum Tube Voltmeter. Test power line frequencies, high audio, radio frequency signals, resistances.

**KIT 3** Practice with resistors, capacitors, coils. Work with half-, full-wave, bridge, voltage doubler and pi-type filter circuits.

**KIT 4** Build circuits with pentode tubes, selenium resistors, transistors. Build oscillator, check signal phase shift with oscilloscope.

**KIT 5** Experiment with thyatron tube circuits, Lissajous patterns. Study basic amplitude detector circuits, modulation, demodulation.

**KIT 6** Get practical experience with magnetic amplifiers, learn to use modified Prony brake; determine motor torque. Use strobe disc to measure motor speed.

**KIT 7** Learn effects of positive and negative feedbacks (used in analog computers). Practice varying polarizing voltage and illumination.

**KIT 8** Experiment with multivibrators used as timing generators in binary counters, and as frequency dividers. Learn to use blocking oscillators, thermistors.

**KIT 9** Practical experience in telemetry circuits used in earth satellites, remote control devices. Work with basic circuits used in digital and analog computers.

**KIT 10** Assemble circuits in electrical and electro-mechanical systems, make valuable practical electronic circuits.

**MAIL COUPON**—New 64-Page Catalog pictures and describes Training Kits, explains what you learn.

NRI is America's oldest, largest home study Radio-Television-Electronics school. For over 45 years NRI has been training men without previous experience for success in Radio-Television Servicing and Communications. Now, expanded uses of Electronics in industry, business and defense are increasing the demand for Electronic Technicians. Four to seven Technicians are needed for every engineer. To meet this demand NRI announces a complete, comprehensive course in ELECTRONICS—Principles, Practices, Maintenance.

This training stresses basic fundamentals because so many Electronic devices are built around identical Electronic principles. It is for beginners, or for Technicians who wish to expand their knowledge.

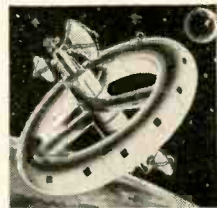

This is the Electronic Age. Electronic Equipment is already being used to count, weigh, control flow of liquids, solids, gases. Control exposure in photography, detect fumes, or fire. Inspect at remote points. Supervise traffic. Survey land areas and ocean contours. Search for oil, miles beneath the surface. Measure radiation and control power levels in atomic installations. Control air traffic. Translate one language into another. The MILITARY applications of Electronics . . . particularly in space rockets and missiles, tracking devices, etc., . . . probably equal all of the uses above. Electronic equipment is used to machine parts through complex cycles. It is used in business to process data, control inventory, prepare payrolls, post, calculate, and in medicine for electrodiagnosis, measure body characteristics, electro-surgery.



**Job Counselors Recommend**  
Right today a career in Electronics offers

unlimited opportunity. Job Counselors know the pay is high, jobs interesting, advancement opportunities great. They advise ambitious, aggressive men who want higher pay now and a better future: "For an interesting career, get into Electronics."

### Learn More to Earn More

Simply waiting and wishing for a better job won't get you ahead. You have to decide you want to succeed and *you must act*. NRI can provide the training you need at home in spare time. No need to go away to school. You don't need a high school diploma or previous Electronic experience. This course is planned to meet the needs of beginners. You work and train with components and circuits you will meet throughout your Electronics career. You get especially developed training kits for practical experience that make Electronics easy, simple to learn.



### Oldest and Largest School

Training men to succeed, is the National Radio Institute's *only* business. The NRI Diploma is respected and recognized. NRI graduates are everywhere throughout U.S. and Canada. Mail the coupon today. New, FREE 64-page Catalog gives facts, opportunities about careers in Industrial and Military Electronics, also shows what you learn, facts about NRI's other courses in Radio-Television Servicing and Radio-Television Communications. Monthly payments available.

OLDEST & LARGEST HOME STUDY RADIO-TV SCHOOL  
**National Radio Institute**  
WASHINGTON 16, D. C. ESTABLISHED 1914

**MAIL THIS COUPON NOW**

NATIONAL RADIO INSTITUTE Dept. IFF  
Washington 16, D. C.

Send me full information without cost or obligation. No salesman will call.  
(Please print.)

Name ..... Age .....

Address .....

City ..... Zone ..... State .....

ACCREDITED MEMBER NATIONAL HOME STUDY COUNCIL

# Radio-Electronics

JUNE 1961  
VOL. XXXII No. 6

Formerly RADIO CRAFT — Incorporating SHORT WAVE CRAFT — TELEVISION NEWS — RADIO & TELEVISION\*

## editorial

Hugo Gernsback 27 MAN into Space?

## radio

Robert F. Scott 28 You and the Citizens Band  
*Questions and answers*  
Robert S. Fisher 50 Ins and Outs of Intercoms  
*How the wireless types work*

## test instruments

Rufus P. Turner 31 Two-Transistor Direct-Reading Capacitance Meter  
*Read capacitance off a meter scale*  
Carl Finzer 53 Service Aids for Transistor Radios  
*Two test instruments you can build*  
Wayne Lemons 66 Two Miniature Tube Checkers  
*You'll want one for your tube caddy*  
Harold Reed 78 Light-Level Indicator  
*Buy six parts and you can build it*

## television

Lawrence Shaw 33 Stacked-B Trouble  
*Headache on the 135-volt line*  
Arthur Cunningham 34 Don't Forget the Antenna  
*It may be the real headache*  
H. R. Holtz 42 Another Weird One  
Wendell Titmus 71 A Curious Trouble  
Jack Darr 80 TV Service Clinic  
*Marginal defects caused by drifting components*

## what's new

46 Pictorial Reports of New Developments

## electronics

36 What's Your EQ?  
Larry Steckler 40 Kits Teach Electronics (Cover Feature)  
*Learn by doing and have fun learning*  
Leon A. Wortman 47 Draw . . . Shoot  
*Electronic Timer shows how quick*  
Martin H. Patrick 55 Transistor Handling Hints  
Louis E. Garner, Jr. 59 New Transistor Has Gain of 30,000  
*A fantastic new composite unit*

## audio-high fidelity

Daniel Meyer 37 Build an All-Transistor Electronic Crossover  
*Active circuits kill attenuation*  
Jack Darr 56 All About Tape Recorders, Part II  
*How level indicators work*  
Homer L. Davidson 70 Transistor Intercom Fills Many Needs  
*Build yourself one; it's a cinch*

## industrial electronics

Tom Jaski 43 How Relays Work  
*First of a series on relays in industry*  
Barron Kemp 72 Infrared Spectroscopy  
*An important industrial application*

## the departments

105 Business and People  
89 Correction  
16 Correspondence  
108 New Books

102 New Literature  
92 New Patents  
84 New Products  
94 New Tubes & Semiconductors

6 News Briefs  
99 Noteworthy Circuits  
82 Technicians' News

90 Technotes  
97 Try This One  
101 50 Years Ago

## Over 50 Years of Electronic Publishing

EDITOR AND PUBLISHER  
Hugo Gernsback

EDITORIAL DIRECTOR  
M. Harvey Gernsback

MANAGING EDITOR  
Fred Shunaman

TECHNICAL EDITOR  
Robert F. Scott, W2PWG

ASSOCIATE EDITOR  
Larry Steckler

EDITORIAL ASSOCIATE  
I. Queen

SERVICE DIRECTOR  
Jack Darr

ART DIRECTOR  
Harry Schlack

TECH. ILLUSTRATION DIRECTOR  
Wm. Lyon McLaughlin

ART ASSOCIATE  
Fred Neinast

PRODUCTION MANAGER  
Elizabeth Stalcup

DIRECTOR, ADVERTISING SALES  
Lee Robinson

EASTERN SALES MANAGER  
John J. Lamson

CIRCULATION MANAGER  
G. Aliquo

DIRECTOR, NEWSSTAND SALES  
Adam J. Smith

PROMOTION MANAGER  
Robert Fallath

Average Paid Circulation  
Over 160,000



## on the cover

With this Electronic Workshop you can build 19 electronic projects, learn how they work, and have fun doing it.

(Story on page 40)

Color transparency  
by Irving Kaufman

## Gernsback Publications, Inc.

EXECUTIVE, EDITORIAL, ADVERTISING OFFICES

154 W. 14 St., New York 11, N.Y.  
Telephone AL 5-7755

CHAIRMAN OF THE BOARD  
Hugo Gernsback

PRESIDENT  
M. Harvey Gernsback

SECRETARY  
G. Aliquo



Radio-Electronics is indexed in  
Applied Science & Technology Index  
(Formerly Industrial Arts Index)

\*Trademark registered U. S. Pat. Office

# GET YOUR ELECTRONICS-TV-RADIO HOME TRAINING FROM N.T.S. RESIDENT SCHOOL

**BREAK THROUGH TO HIGHER PAY, GREATER JOB SECURITY**

**START NOW!** Break through the Earning Barrier that stops "half-trained" men. N.T.S. "All-Phase" Training prepares you . . . at home in spare time . . . for a high-paying CAREER as a **MASTER TECHNICIAN** in Electronics — TV — Radio. One Master Course at One Low Tuition trains you for unlimited opportunities in All Phases: Servicing, Communications, Preparation for F.C.C. License, Broadcasting, Manufacturing, Automation, Radar and Micro-Waves, Missile and Rocket Projects.

**A MORE REWARDING JOB . . .** a secure future . . . a richer, fuller life can be yours! As an N.T.S. **MASTER TECHNICIAN** you can go straight to the top in industry . . . or open your own profitable business.

**Over 1 City Block of Modern School Facilities, Laboratories and Shops Housing Over 1,000 Students.**

**50,000 Graduates — all over the World — since 1905**

**BETTER . . . MORE COMPLETE . . . LOWER COST . . . WITH NATIONAL SCHOOLS' SHOP-METHOD HOME TRAINING!**

**BETTER . . .** Training that is proved and tested in N.T.S. Resident School shops and laboratories, by a School that is the **OLDEST** and **LARGEST** of its kind in the world.

**MORE COMPLETE . . .** You learn **ALL PHASES** OF Television — Radio — Electronics.

**LOWER COST . . .** Other schools make several courses out of the material in our **ONE MASTER COURSE . . .** and you pay more for less training than you get in our course at **ONE LOW TUITION!**

**NATIONAL TECHNICAL SCHOOLS**  
WORLD-WIDE TRAINING SINCE 1905

**THE SCHOOL BEHIND YOUR HOME-STUDY TRAINING**



In these modern School Headquarters your Home Training is: Classroom-Developed, Lab-Studio Planned, Shop-Tested, Industry-Approved, Home Study-Designed.

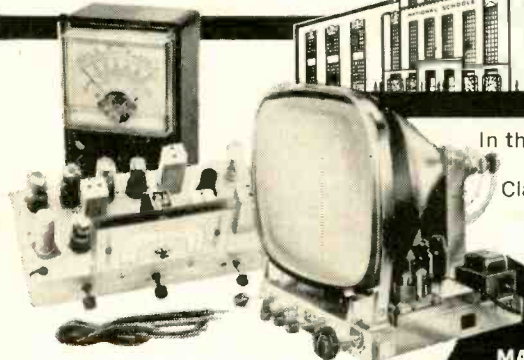

**TRAIN AT HOME IN YOUR SPARE TIME . . . AT YOUR OWN PACE!**

## 19 BIG KITS YOURS TO KEEP

- Friendly Instruction and Guidance
- Graduate Advisory Service
- Unlimited Consultation
- Diploma Recognized by Industry
- **EVERYTHING YOU NEED FOR SUCCESS**

**N.T.S. IS NOT JUST A MAILING ADDRESS ON A COUPON**  
N.T.S. is a real school . . . a world famous training center since 1905. Thousands of men from all over the world come to train in our shops, labs, studios and classrooms.

You learn quickly and easily the N.T.S. Shop-Tested way. You get lessons, manuals, job projects, personal consultation from instructors as you progress. You build a Short-Wave, Long-Wave Superhet Receiver plus a large screen TV set from the ground up with parts we send you at no additional cost. You also get a Professional Multimeter for your practical job projects. The Multimeter will become one of your most valuable instruments in spare time work while training, and afterwards, too. Many students pay for their entire tuition with spare time work. You can, too . . . we show you how.

After you graduate you can open your own TV-Radio repair business or go into high paying jobs like these: Communications Technicians, Hi-Fi, Stereo and Sound Recording Specialists, TV-Radio Broadcasting Technician, Technician in Computers & Missiles, Electronics Field Technician, Specialist in Micro-Waves and Servomechanisms, Expert Trouble Shooter, All-Phase Master Technician, TV-Radio Sales, Service and Repair.

**SEND FOR INFORMATION NOW . . . TODAY! IT COSTS YOU NOTHING TO INVESTIGATE**

**RESIDENT TRAINING AT LOS ANGELES**  
If you wish to take your Electronics-TV-Radio training in our famous Resident School in Los Angeles — the oldest and largest school of its kind in the world — write for special Resident School catalog and information, or check special box in coupon.

**MAIL COUPON NOW FOR FREE BOOK & ACTUAL LESSON**

No obligation.  
No salesman will call.



**NATIONAL TECHNICAL SCHOOLS**  
WORLD-WIDE TRAINING SINCE 1905

Mail Now To  
National Technical Schools, Dept. RG61  
4000 S. Figueroa St., Los Angeles 37, Calif.  
Please rush **FREE** Electronics-TV-Radio "Opportunity" Book and Actual Lesson.

Name \_\_\_\_\_ Age \_\_\_\_\_  
Address \_\_\_\_\_  
City \_\_\_\_\_ Zone \_\_\_\_\_ State \_\_\_\_\_

Check here if interested **ONLY** in Resident Training at Los Angeles.  
**VETERANS:** Give date of discharge \_\_\_\_\_



ACCREDITED MEMBER

**NATIONAL TECHNICAL SCHOOLS**

WORLD-WIDE TRAINING SINCE 1905

4000 SO. FIGUEROA ST., LOS ANGELES 37, CALIF., U. S. A.

# News Briefs

## Electronic Aid for Blind and Deaf

Electronics may in the future assist the blind to see at least in part, and aid the deaf in a new way, stated IRE vice president Prof. Franz Ollendorf at the Institute of Radio Engineers international convention held in March. He told of work done by his colleagues and himself, aimed at helping the blind and deaf with sight and hearing aids that would be connected direct to the brain. This might not come in the near future, he warned, and would not give full vision to the blind. However, if the blind person could see something coming toward him, he could act to avoid it, even though he might not know what it was.

Better results might be expected with electronic aids for the deaf, Professor Ollendorf believes, but the sounds that will reach the brain may not be the same as those received by normal hearing. Deaf persons who have heard in the past would have to learn a new language.

Another aid for the blind was discussed by Prof. Thomas A. Benham of Haverford College, Pa., and his associate Malvern Benjamin. Dr. Benham's device, on which he has worked for some years, uses infrared light in a radarlike device. Obstacles reflect the light to the instrument, which detects the infrared rays and amplifies the signal to a vibrator in the handle. (The general principles of an early form of the instrument were described in Professor Benham's article in the October 1955 issue of RADIO-ELECTRONICS.)

The instrument is being field-tested its developers state, and a curb detector is being developed for use with it. Its greatest use is expected to be

A Micrologic Flipflop photographed on a standard match book. This is the larger of the two Micrologic packages.

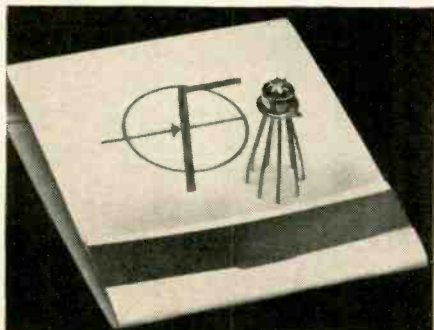

in semi-familiar surroundings, where it would indicate the presence of new and unexpected obstacles.

## Color TV Accelerates

Every indication is that all or most major TV manufacturers will be on the market with a color set next winter, reports *Television Digest*. Though all will be using the new RCA shadow-mask tube, there is renewed activity in the search for a good single-gun tube. General Electric is stepping up its engineering activities with its post-acceleration tube (RADIO-ELECTRONICS, December 1955) and Philco is reported to be working again on the Apple tube and receiver (RADIO-ELECTRONICS, January 1957). Autometric Corp., the Paramount subsidiary now handling the Lawrence tube, is said to be making several developmental receivers a week, and is understood to be almost technically ready to go into production.

"Every indication" is that color TV sales and service will be an extremely important factor in late 1961 and 1962.

## "Micrologic" Elements Cut Digital Circuit Size

A new departure in integrated microminiature circuit design may soon lead to a "90% reduction in size and a 70% reduction in the cost of the logic section of a computer," according to Dr. Robert Noyce of Fairchild Semiconductors, who demonstrated the first of a new series of devices in New York City recently.

Called a Micrologic Flipflop, the element looks exactly like an ordinary transistor except that it has then deposited on top of the slab,

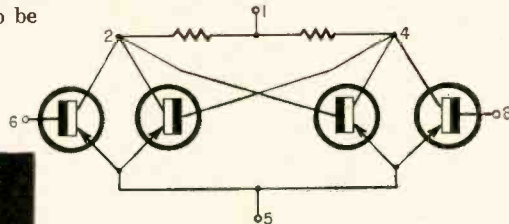

eight leads. As the sketch indicates, it actually contains four direct-coupled transistors, with two load resistors. Terminals 1 and 5 are battery supply and ground; 2 and 4 are outputs, and 6 and 8 are inputs. The Flipflop is made by diffusing the transistors and resistors for many units into a single slab of silicon. The metallic intraconnections are

which is then cut into the individual Micrologic elements. Each of these is mounted in a standard TO-5 or TO-18 transistor case.

The Micrologic Flipflop is the first of a family of six. Five other devices — Micrologic gate, half-shift register, buffer, half adder and counter adapter—will be made available during the year. The six elements can be used to build the complete logic or arithmetic section of a computer. The new Flipflop is priced at \$120, a price which is comparable to the equivalent conventional circuit. "This price will be markedly reduced as production volume and sales increase," Dr. Noyce believes.

## FM STEREO MULTIPLEX AUTHORIZED JUNE 1

Many FM stations begin stereo broadcasting on or shortly after June 1, under an FCC ruling opening the FM broadcast band to stereo on that date. The system used is a modification of that proposed to the commission by General Electric and Zenith. Standards had not been issued at date of writing, but modifications were expected to be minor.

Several companies state that prototype receivers and equipment for converting stations are ready, and that receivers and adapters will be available to the public on or shortly after June 1.

The Zenith-GE system was selected from a group including the Halstead, Crosby, Calbest and Percival systems as one that "will produce stereophonic transmission of good technical quality with only negligible effects on the monophonic main-channel listener", according to the FCC. It uses an AM subcarrier on the main FM carrier, and therefore has the further advantages that adapters or multiplex receivers will be simpler and cheaper, and that a second subchannel can be used for commercial "storecasting", restaurant music and similar services.

Radio-Electronics will describe

**Advertising Representatives:** Los Angeles: Harper-Husted-Coughlin, 400 South Alvarado St., Tel. DUmirk 7-2328. San Francisco: Harper-Husted-Coughlin, 444 Market St., Tel. GARfield 1-0151. United Kingdom: Publishing & Distributing Co. Ltd., Mitre House, 177 Regent St., London, W. 1, England.

**Foreign Agents:** Great Britain: Atlas Publishing and Distributing Co., Ltd., 18 Bride Lane, London E.C. 4.

**Subscription Service** Address form 3579 and correspondence to Radio-Electronics, Subscriber Service, 154 West 14th St., New York 11, N.Y. When requesting a change of address, please furnish an address label from a recent issue. Allow one month for change of address.

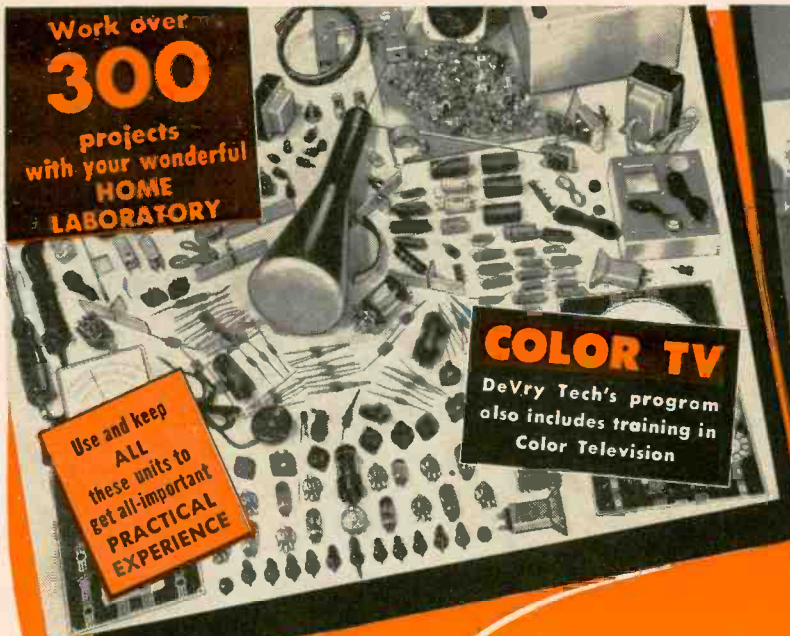

Work over  
**300**

projects  
with your wonderful  
**HOME  
LABORATORY**

Use and keep  
ALL  
these units to  
get all-important  
**PRACTICAL  
EXPERIENCE**

**COLOR TV**

DeVry Tech's program  
also includes training in  
Color Television



**A MILLION DOLLARS IN EQUIPMENT!** Instruments, tools, supplies are available for DeVry Tech students in our Chicago and Toronto Laboratories. Above is shown a Closed Circuit TV station in our Chicago Laboratories.



**NEW!**  
**NEW!**  
**NEW!**

Shown above is the valuable new combination oscilloscope and volt-meter which DeVry Tech men build during the new training program. But that's not all! New movies, new experimental projects—all prepare you thoroughly in this latest and greatest DeVry Tech training program.



*Exclusive*  
**HOME  
MOVIES**

help you grasp  
important points  
**FASTER . . .  
EASIER . . .  
BETTER . . .**  
A tremendous  
advantage!

**NOW...at home...get DeVry Tech's  
amazing effective training in**

# **ELECTRONICS**

**RADIO-TELEVISION!**—Nothing else like it for providing real LABORATORY-TYPE training at home. Get the kind of thorough practical experience YOU NEED for the kind of progress YOU WANT in today's tremendous field of Television, Radio and Electronics. Qualify yourself for real money . . . interesting work . . . a wonderfully promising future. And when you finish, DeVry Technical Institute's active Employment Service HELPS YOU GET STARTED! Or open your own profitable Television-Radio Service Business.

## **THOUSANDS OF SUCCESSFUL GRADUATES**

Why has DeVry Technical Institute become one of the largest training organizations of its kind? Because it provides EVERY MAJOR HOME TRAINING AID to help make the subject EASIER to learn . . . EASIER to remember—the kind of training so helpful for REAL PROGRESS. Students get thorough, up-to-date, practical training that TAKES ADVANTAGE of new and improved training developments. Study the ADVANTAGES shown on this page. Think what they can mean to YOU . . . to YOUR FUTURE! Or come to DeVry Tech's modern Training Laboratories in Chicago or Toronto. MAIL COUPON TODAY for complete facts—including 2 valuable free booklets, "Pocket Guide to Real Earnings" and "Electronics in Space Travel". Also, valuable information for men subject to MILITARY SERVICE.

Accredited member of  
National Home Study Council



**SEND FOR 2 FREE BOOKLETS  
MAIL COUPON TODAY!**

DeVRY TECHNICAL INSTITUTE

4141 Belmont Avenue, Chicago 41, Ill., Dept. RE-6R

Please give me your two free booklets, "Pocket Guide to Real Earnings" and "Electronics in Space Travel"; also include details on how to prepare for a career in Electronics. I am interested in the following opportunity fields (check one or more):

- |  |  |
|--|--|
| <input type="checkbox"/> Space & Missile Electronics | <input type="checkbox"/> Communications          |
| <input type="checkbox"/> Television and Radio        | <input type="checkbox"/> Computers               |
| <input type="checkbox"/> Microwaves                  | <input type="checkbox"/> Broadcasting            |
| <input type="checkbox"/> Radar                       | <input type="checkbox"/> Industrial Electronics  |
| <input type="checkbox"/> Automation Electronics      | <input type="checkbox"/> Special "Short Courses" |

Name \_\_\_\_\_ Age \_\_\_\_\_

Address \_\_\_\_\_ PLEASE PRINT \_\_\_\_\_ Apt. \_\_\_\_\_

City \_\_\_\_\_ Zone \_\_\_\_\_ State \_\_\_\_\_

Check here if you face military service.  
Canadian residents: Write DeVry Tech of Canada, Ltd.,  
1001 979 Lawrence Avenue West, Toronto 19, Ontario

**NEW! ALL NEW!**

**Now Prepare For  
SPACE AND MISSILE  
Electronics At Home**

DeVry Tech now also makes available their highly effective SPACE and MISSILE ELECTRONICS Program. Now a man can train at home for a job in "outer space"—and not only "keep his feet on the ground": he can keep his present job while he is training. DeVry opens a wider range of job opportunities to a wider range of men 17-55.

**DeVRY TECHNICAL  
INSTITUTE**  
**CHICAGO • TORONTO**

# ACRO SOUNDINGS



## A QUESTION FROM MR. GMAXKLT

It was a balmy June day, just six years ago, when we found our morning mail swollen by a postcard from a Mr. W. D. Gmxklt. (At least that's how an archeologist friend of ours deciphered his sanskrit signature.) No offense intended, especially since the zealous Mr. Gmxklt had been kind enough to take the time to write to us as a demonstration of his unbridled enthusiasm for the (then) new Acro UL-1 amplifier he had just assembled.

Since that first welcome communique the irrepressible Mr. Gmxklt has dispatched exactly one postcard per 8.2 months. We've heard his comments, suggestions, news about his own "technical advances" and a request for 4 3/4 inches of a type of wire used in our Ultra-Linear Circuitry. Today Mr. Gmxklt asked his first question.

It seems that news of Acro's Stereo 120 amplifier had just reached him. Now, bewildered, befuddled and apparently bothered, Mr. Gmxklt wants some clear and simple answers.

"If," Mr. Gmxklt wants to know, "you say I need 60 watts per channel for *my* kind of hi-fi, why do other makers hither with a 'measley' 30-watter? On the other hand," he asks, "if less power *will* do the job, why do you bother with that 120 watt block rocker of yours?"

Here, Friend Gmxklt, is your answer: The Acro Stereo 120 is especially designed to wake up any half-decent, low efficiency speaker on the market... to wring out clarity, crispness and quality even the maker may not've realized his speaker capable of... and still have enough reserve power to do some serious roof-raising from time to time—necessary or otherwise.

Gather 'round, and we'll tell you the "inside" secret of this phenomenon. We've discovered a fantastic new European tube that can put out as high as 100 watts in our Ultra-Linear circuit. Since all we need is 60 watts maximum per channel, this amazing development means that the Acro Stereo 120 can run at full power output *continuously*, with rock-solid stability, unmeasurable distortion—and without the slightest hint of strain or pain.

It's that simple, Mr. Gmxklt. When do you want your dealer to deliver?

**ACRO ELECTRONIC PRODUCTS CO.**  
410 Shurs Lane, Phila. 28, Pa.

the accepted system fully in the next issue, and will follow with information on stereo adapters, tuners and receivers.

## Ultrasonics "Sews" Plastics

An ultrasonic device that bonds films of plastic together without heat has been announced by International Ultrasonics Inc., Cranford, N. J. The machine will make perfect, hermetic, noncontaminated seals on many types of plastic that cannot be sealed by dielectric or resistance "heat-sewing" methods.

The device looks much like older plastic "sewing machines," but the head or "welding tip" applies ultrasonic energy to the material, causing the molecules of the interface layers to bond together and making an exceptionally tough seam. The ultra-



sonic generator has an output of about 100 watts and the frequency is in the order of 40 kc.

## Long Waves Do Get Through

Radio propagation theory has been upset by a runaway satellite that is picking up low-frequency signals that should have been absorbed by the ionosphere according to all present beliefs.

Lofti, a small piggyback satellite, failed to separate from its carrier (Transit III-B) and the two went into an unplanned orbit ranging from 100 to 600 miles from the earth. The unplanned orbit caused the satellite to pass in and out of the ionosphere, which permitted scientists of the Naval Research Laboratory to learn some unexpected things. First was the fact that a substantial portion of the very-low-frequency signals (3 to 30 kc) pass through the ionosphere into space. Second and more puzzling was that the velocity of these signals is noticeably reduced when traveling through the ionosphere.

Several practical applications of the new discoveries appear possible. One is the possibility of a global system for communications with submerged submarines, which can communicate only on vlf when under water. Another possibility is a network of vlf stations as navigation radio beacons for manned or unmanned space vehicles.

## Powel Crosley Dead at 74

Powel Crosley, Jr., one of the earliest large manufacturers of radio sets, died in Cincinnati March 28. He was 74 years old.

Crosley first became interested in radio when his son asked him for one, in the early days of broadcasting. When he discovered that the cheapest one on the market cost \$119, he produced his own, and in 1922 was mass-producing the one-tube Harko radio for \$20. Shortly after that he came out with the famous Trirdyn, a three-tube reflex set with a stage of rf, regenerative detector and two stages of audio amplification. It used the book type tuning condenser invented by Hugo Gernsback. For some time Crosley was the world's largest radio manufacturer. Another "largest" was superpower station WLW, which operated at 500 kilowatts till complaints of blanketing over wide areas forced the FCC to cut his power to the present 50 kw.

Powel Crosley expanded his operations into the appliance field, and introduced the shelf-in-door feature now found in all refrigerators, sell-



ing it as the Shelvador. He also experimented with small, low-priced cars for a number of years, but admitted later that he was "10 years too early" with the compact car. At the time of his death, he was the principal owner of the Cincinnati Reds baseball team, in which he had a controlling interest since 1936.

## Ultrasonics at Uhf

A new, efficient device for converting electrical energy into ultrasonic energy and vice versa at microwave frequencies was described by D. L. White of Bell Telephone Laboratories at the recent Institute of Radio Engineers international convention. The new device is a piezoelectric transducer using a semiconductor depletion layer. It will probably find its greatest use in ultrasonic delay lines, where its operation at high frequencies and wide bandwidths will make it possible to store large amounts of information.

The new transducer consists of a plate of piezoelectric semiconductor (such as gallium arsenide) on which a thin metal film is deposited (see illustration). The film constitutes a nonohmic rectifying contact which causes a depletion layer to form. The thickness of the depletion layer can be controlled with a negative bias voltage across the interface. When an ac voltage is applied, most of the



# NEW

TESTS All TV and Radio Tubes  
—both old and new

TESTS the Nuvistors

TESTS the new 10-pin tubes

TESTS the new 12-pin Compactrons

TESTS voltage regulators, thyratrons,  
auto radio hybrid tubes,  
European hi-fi tubes, and  
most industrial types.



**Model 600**  
**DYNA-QUIK**

only **\$69<sup>95</sup>**  
NET

8½" x 11" x 4½"  
Handsome, sturdy  
leatherette-covered  
carrying case

**NEW TUBE  
INFORMATION  
SERVICE**

available every 3  
months for all B&K  
Dyna-Quik Tube Testers



*for the first time, a*  
**B & K QUALITY**  
**TUBE TESTER**  
*at this*  
*amazing low cost!*

*Checks for all shorts, grid  
emission, leakage, and gas*

*Checks each section of multi-  
section tubes separately*

*Checks tube capability under  
simulated load conditions*

*Rejects bad tubes  
—not good tubes*

For the man who wants the performance and reliability of a B&K professional-quality tester at minimum cost . . . there's nothing like the new "600". No other tube tester in this price range is so complete and up-to-date. Tests the newest tube types, as well as the old. It's fast . . . it's accurate . . . it's easy to use. Quickly reveals tube condition. Saves customers. Sells more tube replacements. Stops call-backs. Steps up servicing profit . . . day after day. Pays for itself over and over again.

*Exclusive adjustable grid emission test. Sensitivity to over 100 megohms. Phosphor bronze socket contacts. Complete tube listing in handy reference index. Extremely compact.*

**B & K MANUFACTURING CO.**  
1801 W. BELLE PLAINE AVE • CHICAGO 13, ILL.  
Canada: Atlas Radio Corp., 50 Wingold, Toronto 19, Ont.  
Export: Empire Exporters, 277 Broadway, New York 7, U.S.A.

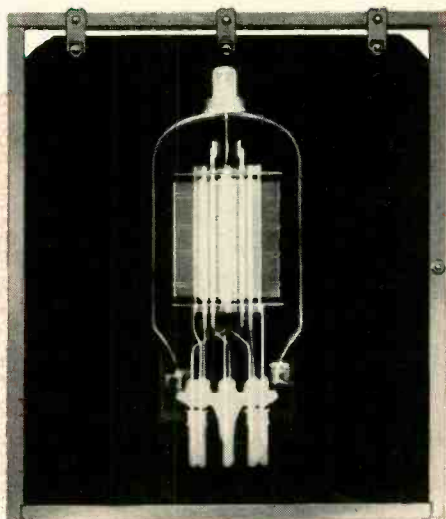

### HORIZONTAL DEFLECTION TUBE PROGNOSIS INDICATES STABLE EMISSION OVER LONG LIFE SPAN

Prolonged observation of Tung-Sol horizontal deflection tubes indicates a consistent behavior pattern: virtual immunity to chronic deflection tube illnesses. They exhibit a remarkable ability to withstand the high temperatures and high pulse voltages encountered in TV deflection service, which too frequently have a fatal effect on tubes of less hardy ancestry. Diagnosis shows unusual physical fortitude. The plate design, with special large area cooling fins

plus high conductivity core aluminum-clad steel material, is a combination of ingredients that safeguards against "hot-spotitis".

Tung-Sol "circuit design"\* approach has eliminated Barkhausen oscillations and snivets.

Qualified specialists agree that continued use of Tung-Sol deflection tubes is certain to result in an epidemic of successful service work of very pleasing proportions.

#### PRESCRIPTION FOR PROFIT

When diagnosis of your customer's TV set reveals an ailing horizontal deflection tube, it's best to prescribe Tung-Sol. Customer satisfaction with the results is certain to be contagious. These are some of the more popular Tung-Sol horizontal deflection tubes:

\*Designed by Tung-Sol to fit circuits already in use in the market.

- |                   |               |          |
|-------------------|---------------|----------|
| 6/12/17/25 BQ6GTB | 6/12/25 BQ6GA | 6/25 DN6 |
| 6/12/17/25 CU6    | 6/12/17 DQ6B  | 6CD6GA   |
|                   | 25CD6GB       |          |



The first name to ask for when ordering

**TUNG-SOL**  
DEFLECTION TUBES

TUNG-SOL ELECTRIC INC., NEWARK 4, N. J.

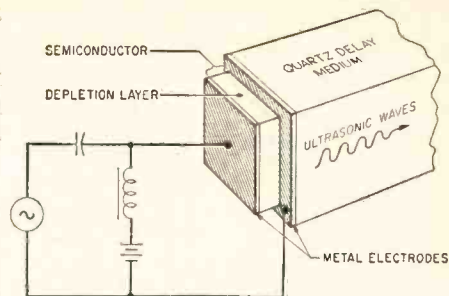

voltage drop occurs across the layer, which then behaves like a very thin piezoelectric crystal bonded to a solid. Since the layer is thin,  $10^{-3}$  to  $10^{-6}$  cm, the electric field is very large and considerable piezoelectric stress can be produced in the layer.

The depletion-layer transducer has several advantages over an ordinary transducer:

Because the layer is so thin, the greatest efficiency of the transducer is at very high frequencies. Current models operate at under 1,000 mc but the frequency range is expected to be extended to above 10,000 mc. In this high-frequency range, this transducer should be as much as 100 times more efficient than any other known transducer.

The thickness of the layer, hence the resonant frequency of the transducer, can be varied by varying the dc bias voltage. This adds great flexibility to its use.

Present models measured at 600 mc have a bandwidth of 5% (30 mc), an order of magnitude larger than that of typical ceramic transducers operating at frequencies below 10 mc. This means that a comparable increase should be expected in the amount of information which can be transmitted.

### New Flat TV Tube?

A new flat display device described by General Telephone & Electronics (Sylvania) laboratory head Stephen Yando may be a step toward a solid-state TV tube. Yando, speaking at the IRE convention, said that work starting as a minor project had become one of the laboratory's major projects. It is "an entirely new combination of electrical phenomena that have been in general use for some years—piezoelectricity and luminescence." Luminescent panels that could show crude moving pictures have been displayed in the past. Apparently the new combination of techniques speeds the process. The final objective—a TV display tube—still remains in the future, and Yando states that "it should be emphasized that much work remains to be done *in the years ahead* [italics ours] before the commercial feasibility of piezoelectric-electroluminescent display can be fully established."

### Radio Scope to Study Jupiter

Yale University has just announced completion of the largest radio telescope on the East Coast,

# how to get a Commercial FCC LICENSE

## An FCC License Or Your Money Back!

Completion of the Master Course (both Sections) will prepare you for a First Class Commercial Radio Telephone License with a Radar Endorsement. Should you fail to pass the FCC examination for this license after successfully completing the Master Course, you will receive a full refund of all tuition payments. This guarantee is valid for the entire period of your enrollment agreement.

## Increase Your Technical Knowledge

Get a government license plus an understanding of such electronic applications as computers . . . industrial electronics . . . radar . . . communications . . . and many more.

## Get This Handy Pocket Electronics Data Guide FREE . . .

Puts all the commonly used conversion factors, formulas, tables, and color codes at your fingertips. Yours absolutely free if you mail the coupon today. No further obligation.

## Not For Beginners!

Please inquire only if you really want to get ahead and to add to what you have already learned in school, in the service, or on the job. Some previous schooling or experience in electronics, electricity, or related fields is necessary for success in Cleveland Institute programs.

## Cleveland Institute Training Results in Job Offers Like These . . .

### ELECTRONICS TECHNICIANS:

RCA has positions for technicians, field engineers & instructor technicians to install, maintain, and teach military radar, communications, and fire control equipment. Company benefits.

### RADIO OPERATORS & TECHNICIANS

American Airlines - Chicago, Detroit, St. Louis, Cincinnati and Cleveland - has openings for radio operators and radio mechanics. Operators must have a 2nd class FCC license and ability to type 40 wpm. Many company benefits.

## CLEVELAND INSTITUTE OF ELECTRONICS

Desk RE54B 1776 E. 17th St. Cleveland 14, Ohio

Mail  
Coupon  
NOW!



good training  
doesn't cost . . .  
it pays!

## get all three FREE!

We can train you to pass your License Exams if you've had any practical experience - amateur military, radio servicing, or other. Our proven plan can help put you on the road to success.

• Your FCC ticket will be recognized by employers as proof of your technical ability.

Accredited by the National Home Study Council

## Cleveland Institute of Electronics



Desk RE54B, 1776 E. 17th St., Cleveland 14, Ohio

Please send Free Career Information Material prepared to help me get ahead in Electronics. I have had training or experience in Electronics as indicated below.

- |   |   |
|---|---|
| <input type="checkbox"/> Military           | <input type="checkbox"/> Broadcasting       |
| <input type="checkbox"/> Radio-TV Servicing | <input type="checkbox"/> Home Experimenting |
| <input type="checkbox"/> Manufacturing      | <input type="checkbox"/> Telephone Company  |
| <input type="checkbox"/> Amateur Radio      | <input type="checkbox"/> Other _____        |

In what kind of work are you now engaged?

In what branch of Electronics are you interested?

Name \_\_\_\_\_ Age \_\_\_\_\_

Address \_\_\_\_\_

City \_\_\_\_\_ Zone \_\_\_\_\_ State \_\_\_\_\_

RE54B

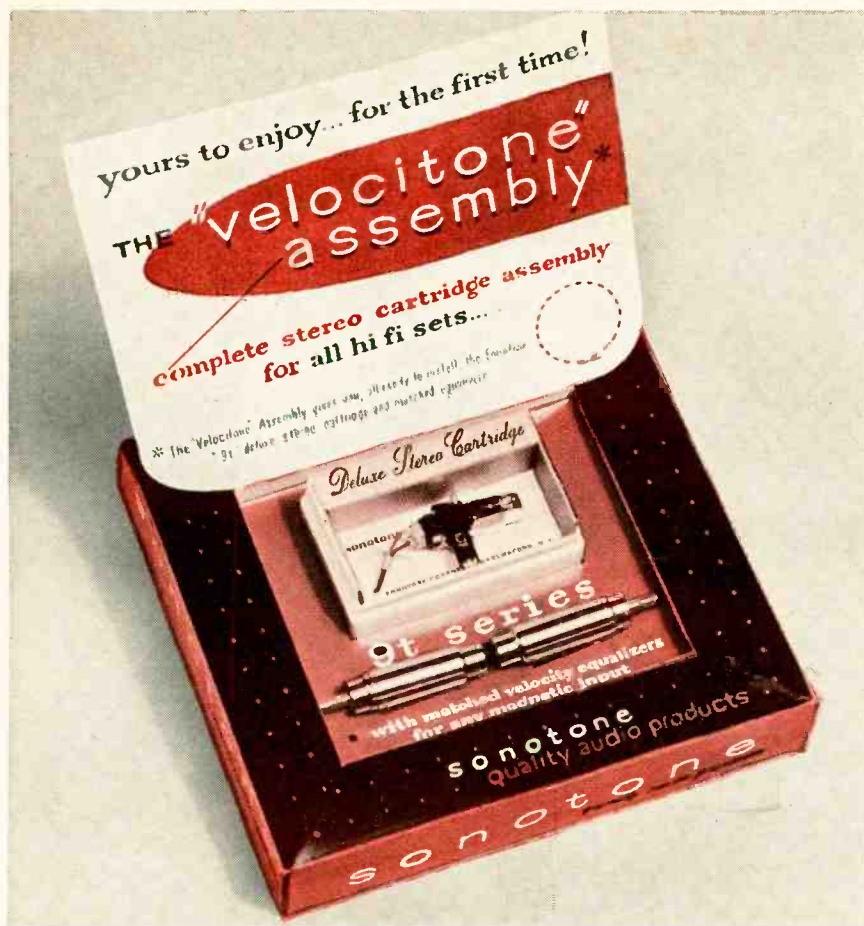

## No stereo cartridge in the world outperforms the *Sonotone Ceramic "Velocitone"*

**Listen!..** with your own magnetic... or with any magnetic you can buy today—at any price. Then replace it directly in your component system with Sonotone's new "VELOCITONE" STEREO CERAMIC CARTRIDGE ASSEMBLY. Listen again! We challenge you to tell the difference. Experts have tried... in dozens of A-B listening tests. And, in every single one, Sonotone's "VELOCITONE" performed as well as or better than the world's best magnetic.

**Listen!..** perfectly flat response in the extreme highs and lows (better than many of the largest-selling magnetics).

**Listen!..** excellent channel separation—sharp, crisp definition.

**Listen!..** highest compliance—considerably superior tracking ability.

**Listen!..** absolutely no magnetic hum—quick, easy, direct attachment to any magnetic inputs.

**Listen!..** remarkable performance characteristics unexcelled anywhere. (Write Sonotone Corporation for specifications.)

Now listen to the price. Only \$23.50... about one-half the price of a good stereo magnetic cartridge. Yet Sonotone's "VELOCITONE" stereo ceramic cartridge system cannot be outperformed by any magnetic—regardless of price.

# Sonotone<sup>®</sup>

CORP.

ELECTRONIC APPLICATIONS DIVISION, ELMSFORD, N. Y., DEPT. C2-61  
IN CANADA, CONTACT ATLAS RADIO CORP., LTD., TORONTO

LEADING MAKERS OF CARTRIDGES • SPEAKERS • TAPE HEADS • MIKES • ELECTRONIC TUBES • BATTERIES

built to study the long-wave radiations from Jupiter. It consists of two wire grids ½ mile apart. Each grid is 110 feet wide, 100 feet high and 200 feet long. The telescope was constructed as a result of the accidental discovery 6 years ago of signals from Jupiter that were of much lower frequency than any that might have been expected from the planet. They indicated either that Jupiter was much hotter than either theory or observation would indicate, or that there was some as yet unknown force behind the radiations. Since the "hotter" theory would have made Jupiter brighter than the sun to observers on the earth, work was started on equipment that could search for the unknown causes.

### Calendar of Events

**IRE-AIEE Global Communications Symposium**, May 22-24, Hotel Sherman, Chicago, Ill.

**IRE-AIEE National Telemetering Conference**, May 22-24, Sheraton Towers Hotel, Chicago, Ill.

**1961 Electronic Parts Distributor Show**, May 22-24, Conrad Hilton Hotel, Chicago, Ill. (Attendance limited to manufacturers and their advertising agencies, representatives and distributors) **Radio-Electronics** will exhibit in room 610.

**EIA Annual Convention**, May 24-26, Pick-Congress Hotel, Chicago, Ill.

**British Radio and Electronic Component Manufacturers' Federation Show**, May 30-June 2, Olympia, London, England.

**Instrument Society of America Conference and Exhibit**, June 5-8, Royal York Hotel and Queen Elizabeth Hall, Toronto, Canada.

**IRE National Symposium on Radio-Frequency Interference**, June 12-13, Sheraton Park Hotel, Washington, D. C.

**IRE Conference on Product Engineering and Production**, June 14-15, Hotel Sheraton, Philadelphia.

**IRE National Conference on Broadcast & Television Receivers**, June 19-20, O'Hare's Inn, Des Plaines, Ill.

**IRE National Convention on Military Electronics**, June 26-28, Shoreham Hotel, Washington, D. C.

**ISA-IRE-AIEE Joint Automatic Control Conference**, June 28-30, University of Colorado, Boulder, Colo.

**British IRE Convention**, July 5-9, Christ Church, University of Oxford, England.

**International Conference on Medical Electronics**, July 16-21, Waldorf-Astoria, New York.

### Wireless Power Transmission

New tubes and new techniques are ushering in a new technology that may permit sending huge amounts of power to areas where wires cannot be strung. W. C. Brown of Raytheon told the international IRE convention.

Key to the expected new technique are new tubes like the Raytheon-developed amplatron. This tube, no larger than an automobile cylinder, can produce over 1,000 kw of radio-frequency power at microwave frequencies—100 kw for each square inch of cathode area. Problems still in various stages of progress are economical generation of the large amounts of power, antennas for efficient transmission and reception, and conversion of the microwave power into more usable forms of electrical or mechanical energy. **END**

# The Same School That Originated The RTS BUSINESS PLAN

**...NOW**  
Proudly  
Presents...

## A SPECIAL COMPACT COURSE COVERING ALL THREE PHASES OF **ELECTRONICS**

The Entire Course Is Made  
Up Of The Following:

- 35 LESSONS COVERING BASIC AND INTERMEDIATE ELECTRONICS
- 9 EQUIPMENT KITS COMPLETE WITH TUBES AND BATTERIES
- SOLDERING IRON
- 25 LESSONS COVERING THESE ADVANCED ELECTRONIC SUBJECTS:

Thyratron Tubes • Semiconductors •  
Electronic Symbols and Drawings •  
Voltage-Regulators • Electronic-  
Timers • Control Systems • X-Rays •  
Photoelectric Devices • Dielectric  
Heating • Geiger Counters • Pulse  
Circuitry • Clippers and Limiters •  
Multivibrators • Electronic Counters •  
Radar • Magnetic Amplifiers • Analog-  
Computers • DC Amplifiers • Digital  
Computers • Storage Systems • Input  
and Output Devices • Servomechanisms •  
Telemetering

- 60 EXAMINATIONS
- UNLIMITED CONSULTATION SERVICE
- KIT MANUALS
- DIPLOMA UPON GRADUATION

**BASIC • INTERMEDIATE • ADVANCED  
DESIGNED FOR THE BUSY MAN OF TODAY**

This is MODERN training for the MODERN man. You'll find no "horse and buggy" methods here. Every page of this streamlined course is devoted to important Electronics principles and practical projects. You'll be amazed how fast you grasp Electronics the RTS way. RTS has combined modern THEORY and PRACTICE to make this the finest training program of its kind available!

**SATISFIES NOVICE, TECHNICIAN OR HOBBYIST**

Whether you're new to Electronics or an old "pro," chances are you'll find this to be the ideal course for you. The novice will appreciate the completeness of the training. It starts with the most basic considerations, covering each important point thoroughly, yet concisely. The technician will enjoy the practical review of fundamentals and profit from the 25 advanced subjects covered.

**RTS GIVES YOU "TOP MILEAGE" FOR YOUR TRAINING DOLLAR**

The price quoted below buys EVERYTHING — there are no extras to pay for. RTS has gone "all out" to give you the best training value in America. Why pay hundreds of dollars for training such as we offer when it's available for this LOW PRICE? If you can find a better training bargain... BUY IT!

**CAN BE COMPLETED IN MONTHS INSTEAD OF YEARS**

Some students will complete this course with "Jet-Like" speed but we allow up to two years if your circumstances require it. You study at your own rate. You are ENCOURAGED but not pushed. You'll find the lessons professionally written but easy to understand. LET US SEND YOU ONE OF THESE LESSONS ALONG WITH YOUR CAREER BOOKLET SO YOU CAN SEE FOR YOURSELF. NO OBLIGATION!

AND MUCH MORE...

RTS' Membership in  
The Association of  
Home Study Schools  
is your assurance of  
Reliability, Integrity and  
Quality of Training.

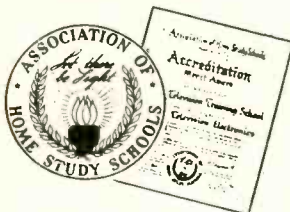

**RTS ELECTRONICS DIVISION**  
815 E. ROSECRANS AVENUE  
LOS ANGELES 59, CALIFORNIA

Est. 1922



L 201

COMPLETE  
COST...  
INCLUDES ALL KITS,  
TUBES, BATTERIES, ETC.  
**\$125.00\***

\*TERMS ALSO AVAILABLE

AS LITTLE AS...

**\$5.00** DOWN

**\$5.00** PER MONTH

THE FIRST TRAINING KIT IS SENT  
IMMEDIATELY UPON ENROLLMENT

**Rush  
Coupon  
for FREE  
FACTS!**

**DON'T LOSE OUT — FIND OUT!**

RTS ELECTRONICS DIVISION Dept. RE61

815 E. ROSECRANS AVENUE LOS ANGELES 59, CALIFORNIA

Rush me full information by return mail. (Please Print)

Name \_\_\_\_\_ Age \_\_\_\_\_

Address \_\_\_\_\_

City \_\_\_\_\_ Zone \_\_\_\_\_ State \_\_\_\_\_

**NO SALESMAN WILL CALL ON YOU!**

# SYLVANIA 6SN7GTB

with 3-point plate support  
 “builds up” your  
**PROFIT PICTURE**



Sylvania extras mean built-in stability, higher performance and extra-long life — profit-protection for you!

Take, for instance, the new structure that supports each plate at three points to substantially reduce microphonics. Or consider how the triode sections are obliquely mounted to reduce catastrophic failure of both sections due to physical shock. Too, Sylvania 6SN7GTB's are built with specially treated micas to reduce interelement leakage; extra-clean welds to cut down on the possibilities of internal shorts.

The technique of grid mounting plus the use of selected alloys for support provides excellent heat dissipation, increased tube reliability. *All this plus:*

- Sylvania “Automount” construction for precise, tight, uniform assembling of tube elements
- a “batch” of 100% tests to assure tube quality
- tapered pins for fast servicing.

The Sylvania profit “build-up” can work for you. Next time you replace a defective 6SN7GTB, make sure it's with a new . . . superior . . . Sylvania 6SN7GTB. Order them today from your local Sylvania tube distributor.

Electronic Tubes Division, Sylvania Electric Products Inc., Dept. 486  
 1740 Broadway, New York 19, N. Y.



# SYLVANIA

Subsidiary of **GENERAL TELEPHONE & ELECTRONICS** 

# a college-level home study program in electronics ...for serious-minded men desiring higher income and status



**CREI's Extension Division offers you a college-level home study program in electronics comparable in technological content to advanced residence courses.**

CREI has developed a program of home study that is comparable in technological content to advanced residence courses in electronics. The program was developed hand-in-hand with leading companies and Government agencies contributing to the Nation's efforts in electronics, communications, missiles, and space exploration.

This CREI program in Electronics Engineering Technology may be completed in 2 to 4 years, depending on how much of your spare time you can devote to study. The courses are presented in easy-to-understand form. Our instructors will give you personal attention and assist you when you need help.

To qualify CREI graduates for advancement to key technical positions, CREI offers a complete program in electronics, including—

**Automation • Instrumentation • Industrial Electronics  
Aeronautical Electronics • Guided Missiles • Radar  
Servo-mechanisms • Computers • Astronautics • Tele-  
metering • Communications • Electronics Manufacturing  
Field Engineering • Nuclear Engineering Technology**

There is a drastic need in the electronics industry for well-educated engineers and technical personnel. Although the great majority of students find ample opportunity for advancement with their present companies, CREI maintains a Placement Bureau to assist graduates and advanced students in finding more desirable positions. For many years, the demand for CREI graduates and advanced students has far exceeded the supply.

.....

Regularly across my desk, comes evidence that CREI's advanced Home Study Program in Electronics has provided an answer both for industry and for far-sighted men, who want to rise to higher levels of achievement. This evidence takes the form of letters from industry leaders and CREI graduates, who express their appreciation for the program and its value in their industry. These letters also state that advancements for CREI men are frequent and extensive. The CREI graduate may enjoy the benefits of new recognition, superior status and higher earnings as a result of his college-level electronics education.

*E. H. Rietzke, President  
Capitol Radio Engineering Institute*

A few of the private companies and government agencies whose officials approve CREI for their own personnel:

U. S. Navy (5,240 enrolled in extension program)	Florida Power & Light
Army, Air Force, Marine Corps, Coast Guard	Pan American Airways
Columbia Broadcasting System	United Airlines
National Broadcasting Company	The Martin Company
Federal Electric Corporation	All America Cable & Radio
	Voice of America
	... and many others

**QUALIFICATIONS FOR CREI.** You qualify if you have a high school diploma or equivalent, and if you have had basic electronic training and practical experience in electronics. Available to Veterans.

Write for our detailed 56-page catalog giving you complete facts, CREI also offers a Residence School program that qualifies graduates for an AAS degree. Day and evening classes.



**Mail this coupon ... today!**

## CAPITOL RADIO ENGINEERING INSTITUTE

ECPD Accredited Technical Institute Curricula • Founded 1927  
Dept. 1406-H, 3224 Sixteenth St., N. W., Washington 10, D. C.  
England: CREI London, Granville House, 132-135 Sloane Street, London S.W. 1, England

Please send me your course outline and FREE 56-Page Book "Your Future in Electronics and Nuclear Engineering Technology" . . . describing opportunities and CREI home study courses in Advanced Engineering Technology.

Check field of greatest interest  Radar, Servo and Computer Engineering Technology  
 Electronic Engineering Technology  
 Communications Engineering Technology  
 Television Engineering Technology  
 Aeronautical Electronic Engineering Technology  
 Automation and Industrial Electronic Engineering Technology  
 Nuclear Engineering Technology

Name \_\_\_\_\_ Age \_\_\_\_\_

Street \_\_\_\_\_

City \_\_\_\_\_ Zone \_\_\_\_\_ State \_\_\_\_\_

Check:  Home Study  Residence School  Korean Veteran

**To obtain fast, immediate service and to avoid delay, it is necessary that the following information be filled in:**

Employed by \_\_\_\_\_

Type of present work \_\_\_\_\_

Education: Years high school \_\_\_\_\_ Other \_\_\_\_\_

Electronics experience \_\_\_\_\_

# WE WANT MERCURY!

... and no wonder they do! **MERCURY TEST EQUIPMENT** meets all their every day servicing requirements and will meet all yours too! You want test instruments that save you valuable time, increase your earning power and build customer goodwill. You want all these things but you don't want to go overboard on price! And you don't have to! Mercury test equipment is priced sensibly low and represents extraordinary value... Brilliantly engineered — constructed of top name brand components — carefully hand-wired throughout. Ask to see them at your jobber today! Learn why thousands of servicemen from coast-to-coast say "We Want Mercury".



**Model 103 TUBE TESTER**



**SPOT  
HARD-TO-  
FIND  
TUBE DEFECTS  
IN JUST  
SECONDS!**

**\$4775**  
Net

The Model 103 is compact in size but is a whale of a money-maker. Although unusually low in price it has a range of operation that will outperform far more expensive testers. It checks all radio and TV tubes (including all black and white picture tubes) for cathode emission, shorts, grid leakage and gas content. The speed and accuracy achieved with the 103 is so great that you will find it profitable to check all tubes when repairing a TV set.

**Model 500 COMPONENT SUBSTITUTOR**



**A complete range  
of components  
at your fingertips  
for fast  
substitution**

**The Model 500  
does the whole job**

**\$2995**  
Net

All the substitutes for electronic components you want and need in your every day work are here in this advanced design component substitutor... more than any other instrument of its type! Covers a full range of resistors, condensers, electrolytics... and also contains many exclusive features covering the substitution of crystal diodes, power rectifiers, power resistors and bias voltages.

**Model 300 COMBINATION TESTER**



**\$9975**  
Net

**3 ESSENTIAL INSTRUMENTS COMBINED INTO  
ONE COMPACT UNIT!**

- Multiple socket tube tester
- CRT tester-reactivator
- Volt ohm milliammeter and capacity meter

Here is a complete portable service shop at your side wherever you go. As a **TUBE TESTER**, it will check cathode emission, inter-element leakage and gas content of all tubes... As a **CRT TESTER-REACTIVATOR** it will test, repair and reactivate all black and white and all color picture tubes... As a **VOM** sensitivity is 20,000 ohms per volt/DC, 5,000 ohms per volt/AC... **Capacity Range:** .001 mfd. to 80 mfd. Handsome wood carrying case.

**Model 800 CRT TESTER-REACTIVATOR**



- TESTS
- REPAIRS
- REACTIVATES ALL BLACK AND WHITE AND ALL COLOR PICTURE TUBES

**\$4995**  
Net

The Model 800 employs a new brilliantly engineered circuit designed to handle every black and white or color picture tube made — whether in the set or in the carton. It will **TEST** for emission, inter-element leakage and life expectancy... **REPAIR** inter-element shorts and weld open elements... **REACTIVATE** low emission tubes with a controlled high voltage pulse (reactivation is seen and controlled on the meter). Wood carrying case.

### Other Mercury profit-making instruments

- Model 201-F Self-Service Tube Testers
- Model 600 In-Circuit Rectifier Tester
- Model 700 Transistor-Diode Tester
- Model 102-P Tube Tester
- Model 400 VOM-Capacity Tester
- Model MH-1 Multi-Head
- Model MP-1 Multi-Probe
- Model MT-1 Multi-Tracer

**SEE THEM AT YOUR LOCAL DISTRIBUTOR OR WRITE FOR CATALOG**



**ELECTRONICS CORP.**

111 Roosevelt Ave.,  
Mineola, N. Y.

manufacturers of quality electronic products

CANADA: Wm. Cohen Ltd., 8900 Park Ave., Montreal • EXPORT: Terminal Radio Int., 240 W. 14 St., N.Y., N.Y.

## Correspondence



### KIT AD

Dear Editor:

I must protest the Paco ad on pages 16 and 17 of the April issue. It is outrageously unfair, untrue and damaging to the kit industry as a whole.

The left page states—not in effect but in so many words—that a kit builder (a) can expect a great deal of trouble sorting out the parts he gets, (b) that it is common to find parts mislabeled, (c) that kit manufacturers usually print instructions and illustrations in such a way that they cannot practicably be used, and (d) that when the kit is finished the constructor may expect it to start a fire.

If these complaints were true of kits at large—or even of any significant number of kits—the kit business would have died long ago. But even though the kit business is very healthy indeed (due to generally high quality, conservatism of manufacturer advertising in adhering strictly to the truth, and extremely gratifying acceptance by that section of the public which has actually built kits), we are constantly striving to convince new people that kit building is what it is cracked up to be. This kind of unethical, false and misleading advertising appeals directly to the fears which we, Heath, Scott, Eico, Dyna and many others have been seeking to allay—the fear that it is too hard to build a kit and that, once constructed, it will not work. Through long, hard, years of sincere persuasion and because of the many thousands of nontechnical people who have been successful with kits, we are succeeding. But I do not propose to stand by while one manufacturer tears down the confidence so hard-earned by the kit industry (of which Heath is the pioneer and we are modest late-comers with only 6 years under our belt).

The facts: Undoubtedly errors occur in identifying parts and a few faulty parts do go to customers. But the incidence of these troubles is tiny and insignificant, and is, if anything, less than one would expect from ordinary human frailty. If you searched our files, you would find an extraordinary number of spontaneous congratulations on the completeness and quality of the parts we furnish—and very, very few remarks in the other direction. I would willingly bet that every other reputable kit maker can say the same!

I have no quarrel with the quality of



# Do you WISH you were EMPLOYED in ELECTRONICS?

## F.C.C. LICENSE—THE KEY TO BETTER JOBS

An F.C.C. *commercial* (not amateur) license is your ticket to higher pay and more interesting employment. This license is Federal Government evidence of your qualifications in electronics. Employers are eager to hire *licensed* technicians.

## WHICH LICENSE FOR WHICH JOB?

The **THIRD CLASS** radiotelephone license is of value primarily in that it qualifies you to take the second class examination. The scope of authority covered by a third class license is extremely limited.

The **SECOND CLASS** radiotelephone license qualifies you to install, maintain and operate most all radiotelephone equipment except commercial broadcast station equipment.

The **FIRST CLASS** radio telephone license qualifies you to install, maintain and operate every type of radiotelephone equipment (except amateur) including all radio and television stations in the United States, its territories and possessions. This is the highest class of radiotelephone license available.

## GRANTHAM TRAINING PREPARES YOU

The Grantham course covers the required subject matter completely. Even though it is planned primarily to lead directly to a first class FCC license, it does this by **TEACHING** you electronics. Some of the subjects covered in detail are: Basic Electricity for Beginners, Basic Mathematics, Ohm's and Kirchoff's Laws, Alternating Current, Frequency and Wavelength, Inductance, Capacitance, Impedance, Resonance, Vacuum Tubes, Transistors, Basic Principles of Amplification, Classes of Amplifiers, Oscillators, Power Supplies, AM Transmitters and Receivers, FM Transmitters and Receivers, Antennas and Transmission Lines, Measuring Instruments, FCC Rules and Regulations, and extensive theory and mathematical calculations associated with all the above subjects explained simply and in detail.

## OUR GUARANTEE

If you should fail the F. C. C. exam after finishing our course, we guarantee to give additional training at **NO ADDITIONAL COST**. Read details in our free booklet.

Get  
Your First Class Commercial

# F.C.C. LICENSE QUICKLY!

## Learn by Correspondence or in Resident Classes

Grantham training is offered by correspondence or in resident classes. Either way, we train you quickly and thoroughly---teach you a great deal of electronics and prepare you to pass the F.C.C. examination for a first class license. Get details now. Mail coupon below.

This booklet  
**FREE!**

This free booklet gives details of our training and explains what an F.C.C. license can do for your future. Send for your copy today.

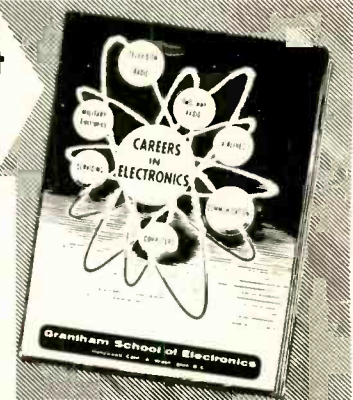

To get ahead in electronics—first, you need the proper training; then, you need “proof” of your knowledge. Your first class commercial F. C. C. license is a “diploma” in communications electronics, awarded by the U. S. Government when you pass certain examinations. This diploma is recognized by employers. Grantham School of Electronics specializes in preparing you to **earn** this diploma.

Grantham training is offered in resident classes or by correspondence. Our **free** booklet gives complete details. If you are interested in preparing for your F. C. C. license, mail the coupon below to the School's **home office** at 1505 N. Western Ave., Hollywood 27, California—the address given in the coupon—and our free booklet will be mailed to you promptly. No charge—no obligation.

# Grantham School of Electronics

HOLLYWOOD  
CALIF.

SEATTLE  
WASH.

KANSAS CITY  
MO.

WASHINGTON  
D. C.

RESIDENT CLASSES  
HELD IN FOUR CITIES

If you are interested in attending day or evening classes mail the coupon for free information to our home office in Hollywood, Calif.



(Mail in envelope or paste on postal card)

To: **GRANTHAM SCHOOL OF ELECTRONICS**  
1505 N. Western Ave., Hollywood, Calif.

Gentlemen:

Please send me your free booklet telling how I can get my commercial F.C.C. license quickly. I understand there is no obligation and no salesman will call.

Name \_\_\_\_\_ Age \_\_\_\_\_

Address \_\_\_\_\_

City \_\_\_\_\_ State \_\_\_\_\_

**I am interested in:**  Home Study;  Seattle classes

Hollywood classes,  Kansas City classes,  Washington classes

14F

MAIL COUPON NOW—NO SALESMAN WILL CALL →



on the  
**CITIZENS BAND-**  
**LESS SIGNAL LOSS WITH**



**polyfoam**<sup>®</sup>

As serious operators are fast discovering, AMPHENOL Polyfoam cable is the very best choice for citizens band antenna systems. Compared to RG-8/U, AMPHENOL's 621-111 Polyfoam equivalent has up to 35% less signal loss. For the low power citizens band, Polyfoam's low loss is a vital factor in increased signal strength.

Polyfoam has other advantages. It's lightweight and easy to handle. It assembles quickly to coaxial terminations such as AMPHENOL 83-1SP. And its cost is surprisingly low. You can buy all this in low-loss AMPHENOL Polyfoam 621-111 for a mere 3¢ more a foot than RG-8/U!

*Insist upon genuine AMPHENOL Polyfoam cable, available through your Authorized AMPHENOL Distributor.*



**AMPHENOL DISTRIBUTOR DIVISION**  
**BROADVIEW, ILLINOIS**  
*Amphenol-Borg Electronics Corporation*



Paco kits, nor even with their saying they avoid the possible problems detailed so luridly in the ad. If they strive for superior quality and more expensive and better packaging, so much the better and good luck to them! Scott, too, in the ad on page 71 of the same issue, and in many other very good ads, is selling the public their idea of quality in kits—and with a truthful, sincere, convincing story told honestly and well. But in telling us about their kit quality, Scott does not find it necessary to say everyone else's kits are hard to build and dangerous!

The public has found over the past few years that building kits is not difficult, is fun, can be done by people without technical training, and saves a good deal of money while yielding first-rate quality. Paco's approach is calculated to destroy confidence in kits and thus deprive the public of these enormous benefits.

RICHARD H. DORF

*Schober Organ Corp.*  
*New York, N.Y.*

**PATENT WON'T WORK**

*Dear Editor:*

I wish to comment on the "Ignition System" patent (No. 2,955,248) which was described in the New Patents section, pages 90-91 of the April issue. This system will not work as designed. Diode D is presumably intended to isolate the ignition-coil voltage spike from the transistor, but it will not do this. To see why, refer to the basic physical law that an inductance will tend to resist any changes in the current flowing in it. Thus, when the current is switched off, the inductance will cause a voltage spike across the switch which is much greater than the normal drop, in an effort to maintain the current. This means that, in the circuit shown, the end of the coil primary connected to the diode will go strongly negative when the transistor is cut off. This voltage spike will be applied to the transistor through the forward direction of the diode, and the diode will not protect the transistor against this spike.

In addition, the base circuit shown is much more elaborate than need be. All that is required is a resistor connected from base to -12 volts. It should have a value that will pass enough base current to saturate the transistor on the coil current. The contact points would be connected in series with this resistor, cutting off the transistor when open.

CHARLES ERWIN COHN

*Chicago, Ill.*

[The patent may have been intentionally wrong. Some people, in "revealing" their inventions, slip in a gimmick. In this case it may be a backwards diode. The added complexity in the base circuit may have been necessary to avoid infringing on an existing patent.—Editor]

**FLASH COMMENT**

*Dear Editor:*

I was interested in the article "Inside the Electronic Photoflash," in the March (Continued on page 22)

RADIO-ELECTRONICS

# NEW—simply great **knight-kits**<sup>®</sup>

A PRODUCT OF ALLIED RADIO

talk of the kit world...only at **ALLIED**

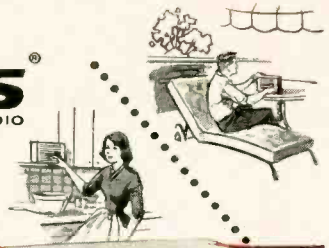

measures  
engine speed,  
0-8000 rpm



it's **WIRELESS**—  
just plug in  
and **TALK!**

## New Money-Saving Electronic Tachometer Kit

3% Accuracy Regardless of Temperature or Voltage Variations

Until Aug. 1 **\$19.95**  
No Money Down

Another KNIGHT-KIT first—a precision tachometer in money-saving, easy-to-build form. Helps you drive at your best engine speed efficiency, like the professionals. Transistor switching and Zener diode regulator contribute to exceptional 3%-of-full-scale accuracy, regardless of voltage or temperature changes. Operates with 4, 6 or 8 cylinder automotive engines; simple installation. Ideal also for outboard marine engines using battery or magneto ignition system from 2 cycle 2 cylinder and up. Big illuminated D'Arsonval meter; 0-8000 rpm scale; separate reference pointer may be preset to any desired speed. For 12-volt systems only. With cables, mounting hardware, wire and solder. Shpg. wt., 2 lbs.

83 Y 944. For negative ground systems (American cars).

83 Y 980. For positive ground systems (Foreign cars).

No Money Down. INTRODUCTORY PRICE EITHER TYPE... **\$19.95**

## Deluxe Wireless Intercom System Kit at Lowest Cost

Works Anywhere Without Wires — No Installation!

This easy-to-assemble intercom operates without installation or wiring—just plug into any AC or DC wall outlet for step-saving communication! Change locations easily—anywhere. Ideal for home, office or store. In the home, you can communicate with nursery, garage, basement or patio. In office or shop, provides time-saving communication. Will operate between adjacent buildings that are on same electric-company line transformer. Perfect for baby sitting. Features power-line noise silencing circuit for absolutely quiet "standby"; premium quality throughout. Has Talk-Listen switch, with lock-on feature for constant listening. Handsome cream-toned plastic cabinet, 9 x 5½ x 5½". Can be used in systems consisting of 2 or more units, as desired. Shpg. wt., 3½ lbs.

PAIR  
**\$37.90**  
No Money Down

20 YX 272-2. Complete 2-Station System. NET... **\$37.90**  
83 Y 941. Additional Station. NET EACH... **\$18.95**

SEE DOZENS OF GREAT  
**knight-kit** BUYS in  
**Allied's Summer Sale Book!**

Make your money-saving selections from page after page of great KNIGHT-KIT values and special offers! Save most on the best in build-your-own Stereo, hobby, instrument and Ham kits. Also see terrific closeouts on tape recorders, phonos, records and tape; specials in radios, cameras, TV accessories, Citizens Band radio, amateur gear, P.A., test instruments, tools and electronic parts. Send coupon today!



SEND  
FOR IT  
NOW!

**SAVE AS NEVER BEFORE**  
on everything in Electronics—  
hundreds of special bargains—  
dozens of new products! Write  
for this big value-packed Sale  
Book today!

**free**

ALLIED RADIO, Dept. 34-F1  
100 N. Western Ave., Chicago 80, Ill.

Send **FREE** Allied Sale Book No. 205

Ship me the following:

- 83 Y 944 Tachometer Kit.  20 YX 272-2 Intercom System  
 83 Y 980 Tachometer Kit.  83 Y 941 Intercom Station

\$..... enclosed

Name \_\_\_\_\_  
PRINT  
Address \_\_\_\_\_  
City \_\_\_\_\_ Zone \_\_\_\_\_ State \_\_\_\_\_

**ALLIED RADIO**

# NEW BELL LABORATORIES RESEARCH FORESHADOWS COMMUNICATIONS AT OPTICAL FREQUENCIES

A revolutionary new device, the continuously operating Optical Gas Maser, now under investigation at Bell Telephone Laboratories, foreshadows a whole new medium for communications: light.

Light waves vibrate at frequencies tens of millions of times higher than broadcast radio waves. Because of these high frequencies, a beam of light has exciting potentialities for handling enormous amounts of information.

Now for the first time, Bell Laboratories' new Optical Gas Maser continuously generates light

waves that are "coherent." That is, the light waves move in phase as seen looking across the beam.

With further research, it is expected that such beams can be made to carry large amounts of information. The beams can be transmitted through long pipes. They can be projected very precisely through space, and might be used for communications between space vehicles.

Research with coherent light is another example of how Bell Laboratories prepares ahead for communications needs.

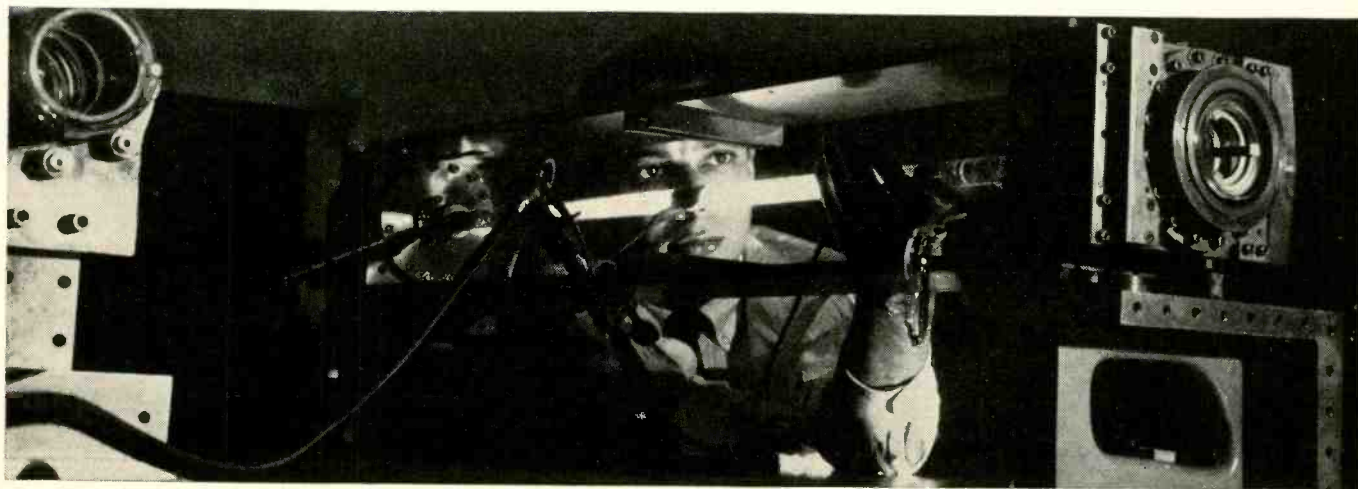

The Optical Gas Maser (above) was first demonstrated at Bell Telephone Laboratories. Heart of unit is a 40-inch tube containing helium and neon. Interaction between gas atoms produces a continuous, coherent beam of infrared light that may one day be used in communications.



## BELL TELEPHONE LABORATORIES

WORLD CENTER OF COMMUNICATIONS RESEARCH AND DEVELOPMENT



# LET RCA TRAIN YOU IN ELECTRONICS

*RCA Institutes, one of the world's leading electronic technical schools, offers Home Study Courses in . . .*

## **RADIO, TV, TRANSISTORS, AUTOMATION**

. . . Now you have five comprehensive courses for your electronic training. Practical work with the very first lesson. With the new Voluntary Tuition Plan, you pay for each study group only when you order it. If you interrupt the course at any time, for any reason, you don't pay until you resume the course.

Even if you have not completed high school, you can begin your electronic career training at RCA Institutes. Choose from any of these courses.

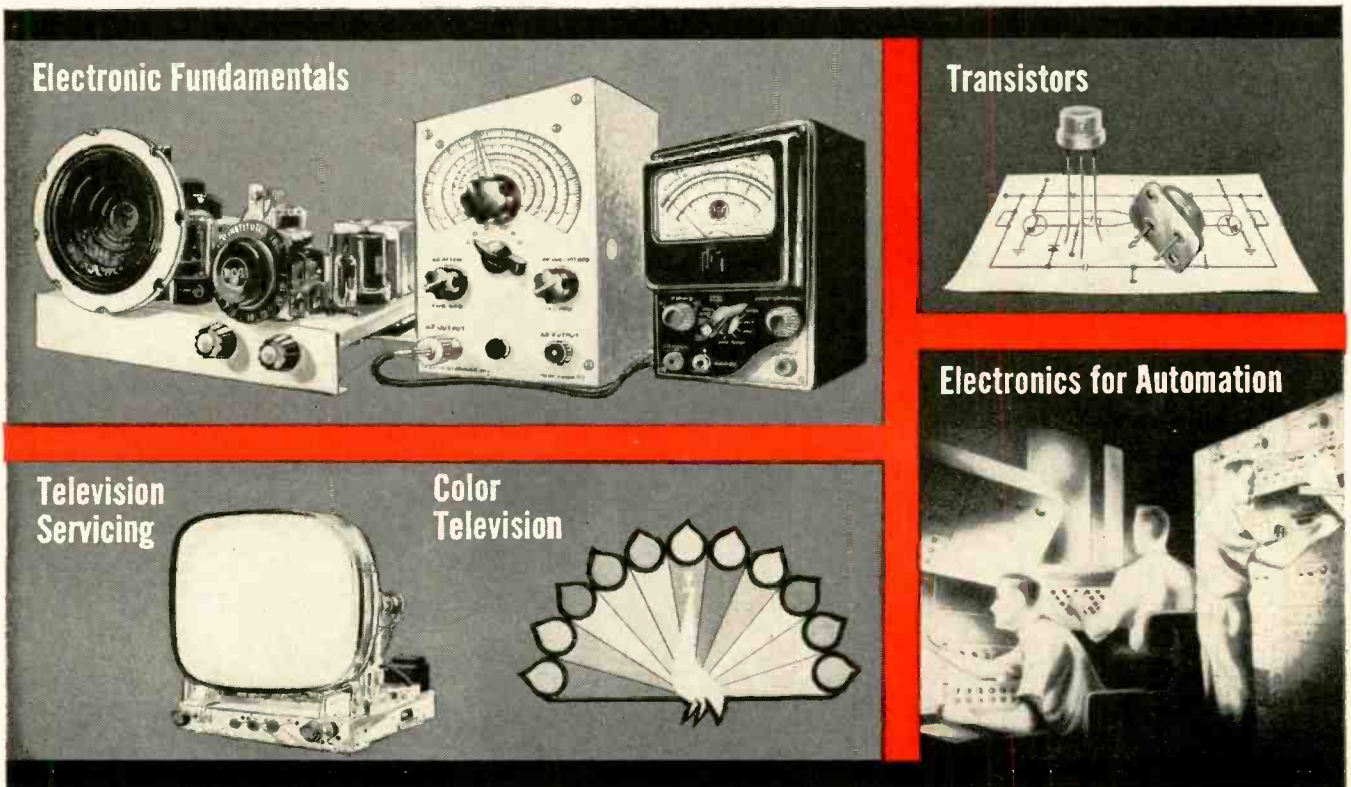

Send for our  
64 page Home  
Study Catalog

**FREE!**

RESIDENT SCHOOLS in New York City and Los Angeles offer Technical Institute and Vocational School Courses in Electronics. Day and Evening classes start 4 times each year. Resident School Catalog sent free on request.



**RCA INSTITUTES, Inc.** Home Study School, Dept. ZRE-61  
A Service of Radio Corporation of America  
350 West Fourth Street, New York 14, N. Y.

Please rush me your FREE illustrated 64-page book "Your Career in Electronics," describing your home training programs. No obligation. No salesman will call.

Name ..... Age .....

Address .....  
Please print

City ..... Zone ..... State .....

Veterans: Enter discharge date .....

**CANADIANS** — Take advantage of these same RCA courses at no additional cost. No postage, no customs, no delay. Send coupon to:  
RCA Victor Company, Ltd., 5581 Royalmount Ave., Montreal 9, Quebec  
To save time, paste coupon on postcard.



# FIELD ENGINEERS

For Univac  
Missile-Guidance  
Computers & Tactical  
Data Systems

Field engineers are now being selected for maintenance assignments on ultra-reliable Univac missile-guidance computers and other military electronic data processing systems.

Openings involve maintenance of the Univac ICBM guidance computer, first of its size to be completely transistorized.

Applicants must have at least 2 years of formal education in Electronics with 3 or more years in maintenance or maintenance-instruction. Experience should be associated with complex electronic equipment such as TV, radar, sonar or digital computing systems.

Before assignment, you receive 2 to 6 months training at full pay in our St. Paul, Minnesota, laboratories. Benefits include company paid life insurance, hospitalization, medical and surgical benefits, relocation expenses and living allowances at field sites.

Openings also for qualified instructors with backgrounds similar to above.

Send complete resume of education and experience to:

R. K. PATTERSON, Dept. Q-6

**Remington Rand**  
**Univac**

Division of Sperry Rand Corporation  
2750 West 7th St., St. Paul 16, Minn.



(Continued from page 18)

issue (page 36), since our organization does a fair amount of this work. I was glad to get the schematics on the Braun Hobby units which E. Leitz, Inc. had refused to part with for love or money although I have been able to get parts from Leitz with no trouble. The European transistors shown in the schematics can all be replaced with the 2N265 or equivalent, with the exception of the TF 80/30 which can be replaced with the 2N555.

At numerous points in the article, it became apparent that Mr. Henry had not serviced these units to any extent. The most outstanding instance was where he suggests that you get a roll of film and shoot pictures with the flash unit you just repaired. E. Leitz Inc. pays \$4.50 for the warranty repair of any Braun Hobby. Can you imagine taking a Braun Hobby down, troubleshooting it, making the repair, reassembling the unit, paying for a roll of film, taking the time to shoot eight pictures, paying for the development and still trying to show a profit? If you insist on making light-intensity checks, use a light-intensity meter.

THOMAS L. BARTHOLOMEW  
Washington 10, D.C.

[What is apparent is that Mr. Henry has not been doing *warranty* servicing to any extent. Our correspondent has pointed up a weakness of much warranty servicing—you cannot afford to do a good job. For regular service work, shooting a roll of film would be amply justified and is a service that many professional photographers would be delighted to pay for—at industrial rates.—*Editor*]

## OTHER SIDE OF THE STORY

Dear Editor:

I get a little annoyed when I read letters and articles in your publication that continually growl about part-time and/or amateur technicians. The writers seem to think that distributor's parts houses are a private domain for the exclusive use of the "full-time" technician, yet most refuse to stock even the most common items for sale to others.

After having had the opportunity to examine the work done by many repair shops, I have concluded that **the only thing that shop owners have to fear is their own incompetence.** I had hoped that the electronics repair business would not fall into the same class as many other so-called "professional" areas.

Medical doctors have had laws passed to protect them from the public, resulting in mediocrity instead of medicine. The farmers have a lobby whose sole responsibility is to demand that government reward them for their own inefficiency. Trade unions have forced business to retain the incompetent along with the craftsman. And so it goes, carpenters can't build a well constructed house, teachers can't teach and preachers are dull beyond belief. We are becoming a country of mediocrity turning out mediocre products.

There are still a few craftsmen, but

they never need to fear competition from the tyro. So if you want to eliminate amateur competition, for the sake of heaven, don't try to do it by legislative decree, do it by your own greater knowledge, ability and professional work. You want to be called "professional" technicians but you must be professional to earn the title.

K. E. ROMBOUGH  
APO 953, San Francisco, Calif.

## DEAR MR. FIPS

Most Revered and Esteemed Fips:

Again I must congratulate you. I refer to your 30-day LP record described in the April issue. Once again, you have anticipated me, but perhaps I have managed to discover a facet of this device not yet mentioned.

The recording device you have produced can play back records at normal speed, it is true, but, if we speed up the turntable, it would be possible to increase greatly the upper frequency response of the recording. This would decrease the available playing time but would make it possible to record a few hours of television on the disc. This would enable a small TV station to keep a complete record of important shows on a small bookshelf. It would also enable the family to record one TV program while watching another.

Of course, for the economical, it would be possible to record a separate musical program along with the TV material. As the video signal would be in the rf, and the af of the music would not modulate it, you would have two discrete signals, both on the same recording! Using this system, the music could be recorded for the audiophile in the listening room (see "A Proposed Listening Area," *Institute of Synergistic Statics Proceedings*, Vol. XL, No. 2), while the other members of the family re-view their favorite program.

And there it is, not only will we still have hi-fi records, but in addition we will have video recorders for home use. And do you, most learned Fips, believe that this will cause a reduction in electronic equipment sales? Hardly.

So tell that mean old boss of yours that you have discovered a revitalizing force for the already booming electronic industry!

STEPHEN A. KALLIS, JR.  
Buffalo 26, N. Y.

[Thanks ever so much for your fine letter. Yet, in all modesty, I must tell you that your suggestions had, of course, not only been anticipated, but are all in my Patent Application.

There was not sufficient space to publish all of them. Here are a few more you did not think of.

By running *two* separate paths together (parallel), I got almost any conceivable stereo effect desired. The same technique is used to record video and its sound channel, using parallel paths.

I can increase the capacity of the disc 40% or more by making the "disc" into an elevated cone, like a low hill.

There are several more ideas, but the bugs have not been (magnetically) ironed out.—*Fips*]

END

# Analyze Every Transistor Circuit Trouble in Minutes!

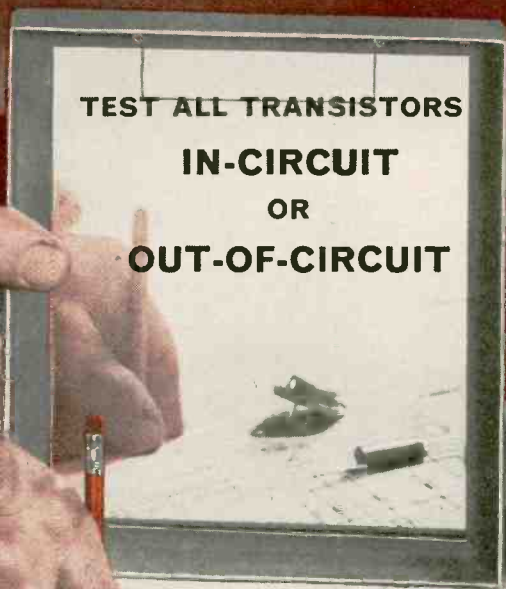

Now you can...

It's a... **COMPLETE TRANSISTOR TESTER • SIGNAL TRACER  
VOLTMETER • BATTERY TESTER • MILLIAMETER**

Transistors are tested in-circuit with a new unique AC GAIN check and out of circuit with an accurate DC GAIN and LEAKAGE check. Set-up chart included for reference only.

- Test all transistors in-circuit with a new unique AC GAIN check. It works every time and without the use of the set-up booklet.
- Test all transistors out of circuit with the AC GAIN check or with a more accurate DC current gain and leakage check.
- Read current gain (beta) direct for experimental, engineering work or for matching transistors.
- Check diodes simply and accurately with a forward to backward ratio check.
- Signal trace from speaker to antenna with a special low impedance generator. No tuning, adjustments, or indicating device needed for transistor radio trouble shooting. Just touch output leads to transistor inputs and outputs until 2000 cycle note is no longer heard from speaker. (Generator output monitored by meter.) It's a harmonic generator for RF-IF trouble shooting and a sine wave generator for audio amplifier trouble shooting.
- Check batteries under operating conditions as well as the voltage dividers with a special 12 volt scale.
- Monitor current drawn by the entire transistor circuit or by individual stages with a 0 to 50 Ma current scale. A must for alignment and trouble shooting cracked boards.

## Benefit from these Sencore extras

- Lists Japanese equivalents.
- Automatically determines NPN or PNP.
- Mirror in detachable cover to reflect opposite side of printed board.
- Special clip to fit between batteries for current check.
- Transi-probe for making in-circuit transistor checks.

Color.....modern two tone gray  
Size.....8" x 7½" x 3"  
Weight.....only 5 lbs.  
Meter.....0 to 3 Ma, 3½", 5% tolerance,  
modern plastic  
Batteries.....two size "C" cells

Model TR-110 **ONLY 49<sup>50</sup>**

ALL PARTS ARE **SENCORE** MADE IN AMERICA

# SENCORE

ADDISON, ILLINOIS



Sencore Sam says, "If you'd like to get rid of those batteries during repair time, get the Sencore PS103 Battery Eliminator. It's the best and it's only \$19.95."

Another outstanding product by the **HIDDEN 500\*** who plan for your future:

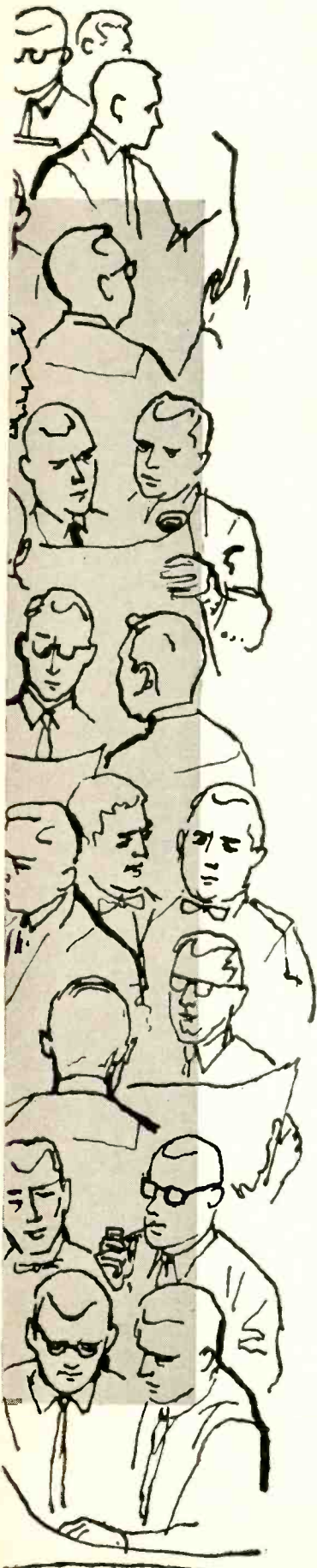

## TYPE TE LITTL-LYTIC® CAPACITORS



Transistors revolutionized the industry. And to make the most of their inherent advantages, they called for an entirely new group of components. Here, Sprague Research was the first to answer the call with the smallest truly reliable dry electrolytic made for transistor circuits—the Littl-Lytic. This reasonably priced capacitor is the most reliable subminiature you can buy for transistorized radios, hearing aids, wireless microphones, pocket wire recorders, and other miniature electronic equipment.

The remarkable reliability of Littl-Lytic is the result of a new manufacturing technique in which *all the terminal connections are welded*. Units are hermetically sealed and metal encased . . . *with no pressure joints* . . . there are no “open circuits” with the passage of time. Leakage current is extremely low as the result of the use of high purity foil and ultra-stable formation techniques. Sprague’s catalog replacement ratings are the most comprehensive in the industry. They assure you of exact replacements to meet your day-to-day service requirements.

Littl-Lytic is a typical example of how Sprague Research keeps its products up-to-the-minute. Reliable components mean reliable service work—your business keeps pace with the electronic industry when you use Sprague.

\*The “Hidden 500” are Sprague’s 500 experienced researchers who staff the largest research organization in the electronic component industry and who back up the efforts of some 6,000 Sprague employees working in 14 manufacturing operations—four at North Adams, Mass.; Bennington and Barre, Vt.; Concord and Nashua, N.H.; Lansing, N.C.; Grafton, Wis.; Visalia, Calif.; two at Ponce, Puerto Rico; and Milan, Italy.

don't be vague . . . insist on

# SPRAGUE®

world's largest capacitor manufacturer



# LAFAYETTE is America's Citizens Band Headquarters

Complete Portable Communications for Everyone

**NO LICENSES,  
TESTS OR  
AGE LIMITS**



Ship  
to  
Shore



For  
Farming



Construction  
Work



HE-29

**COMPLETELY  
PORTABLE—  
POCKET SIZE**  
Only  
6 3/8 x 3 1/4 x 1 5/8"

## LAFAYETTE 9-TRANSISTOR CITIZENS BAND "WALKIE TALKIE"

**49.95**  
2.00 Down  
**2 for 96.50**

- Completely Wired—Ready to Operate
- Fully Transistorized — 9 Transistors plus 1 Diode
- Uses Inexpensive Penlight Batteries • No License, Tests or Age Limits • Comes with Leather Carrying Case, Earphone, Antenna, Batteries and Crystals

As simple and easy to use as the telephone—and twice as handy. Receives and transmits up to 7 miles under favorable conditions, or 1.5 miles under average conditions. Weighs only 18-oz. and slips into your pocket. Push-to-talk button operates built-in speaker as sensitive microphone.

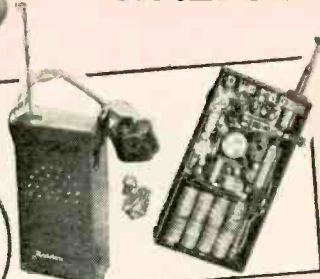

Complete with Leather Carrying Case, Earphone, Antenna, Batteries, and Crystal

## LAFAYETTE HE-20A Deluxe CITIZENS BAND TRANSCEIVER

ONLY  
**109.50**  
5.00 Down



MADE IN U.S.A.

Now With Added Deluxe Features—

- Pi-Network for Greater Power Output • Calibrated "S" Meter
- 14 Tube Performance, 3 Diodes • Built-in 12 Volt Power Supply for Mobile Use • Complete with Matched Crystals for Channel 9

A highly efficient 2-way communications system operating over a distance of up to 20 miles or more depending on terrain. Features 4 crystal-controlled transmit positions and 4 crystal-controlled receive positions. Tuneable superhet receiver covers all 23 assigned channels. Other highlights include dependable push-to-talk ceramic mike & relay, adjustable squelch control, automatic series gate noise limiter and illuminated dial.



## LAFAYETTE HE-15A

ONLY  
**57.50**  
5.00 Down

MADE IN U.S.A.

## SUPERHET Citizens Band TRANSCEIVER

- Completely Wired—Not A Kit • 5 Crystal-Controlled Transmitting Positions
- Tuneable Receiver Over Full 23 Channels • High Output Crystal Microphone • Complete with Transmitting Crystal for Channel 9

A compact, precision transmitter and receiver covering up to a 20 mile or more radius, depending upon conditions. The HE-15A features an effective full-wave variable noise limiter, RF jack on front panel, planetary vernier tuning, 5-prong microphone jack for easy relay addition, and 12 tube performance from 4 dual-function tubes, 2 single-function tubes, 2 rectifiers.

- HE-19 Telescoping Whip Antenna ..... Net 3.95
- HE-16 Power Supply for 12 Volts ..... Net 10.95
- HE-18 Power Supply for 6 volts ..... Net 10.95

HE-800WX

## LAFAYETTE ALL-IN-ONE CITIZENS BAND MOBILE ANTENNA

The Scoop Buy for Citizens Band Mobiles

**6.95**

- Chrome Swivel Base • Stainless Steel Spring • 102 1/2" Stainless Steel Whip for Optimum 11-Meter Performance

Chrome swivel ball mount base designed for mounting on any surface. Stainless steel spring holds rod in properly adjusted position and prevents rod damage from shocks and blows. Stainless steel whip for maximum resiliency and strength.

## NEW! LAFAYETTE RADIO FIELD INDICATOR

- Continuously Indicates Transmitter Output
- Rugged 200 ua Meter Movement
- Requires No Electricity, Batteries or Transmitter Connection

Check the performance of marine, mobile or fixed transmitter. Features a 200 ua meter movement with variable sensitivity control. Earphones can be plugged in for an aural check of output. Antenna extends from 3 1/4" to 10 3/4". Magnet on bottom plate allows easy mounting on car dash or metal surfaces. Size, less antenna, 3 3/8W, 2 1/4H, 2"D.

A Must  
for All  
Ham  
and  
CB  
Operators

**6.95**



# LAFAYETTE RADIO

PLEASE INCLUDE SHIPPING CHARGES WITH ORDER

165-08 LIBERTY AVENUE, JAMAICA 33, N. Y. • OTHER LOCATIONS

NEW YORK, N. Y.  
100 6th Avenue

NEWARK, N. J.  
24 Central Avenue

BRONX, N. Y.  
542 E. Fordham Rd.

PARAMUS, N. J.  
182 Route 17

BOSTON, MASS.  
110 Federal Street

PLAINFIELD, N. J.  
139 W. 2nd Street

# EICO®...UNCOMPROMISING ENGINEERING

**BEST BUYS IN SERVICE INSTRUMENTS:** everything from Scopes to Probes



DC-5 MC  
5" Scope #460  
Kit \$79.95  
Wired \$129.50

Also Avail.—5" Push-Pull Scope #425  
Kit \$44.95 Wired \$79.95



Peak-To-Peak  
VTVM #232  
& Uni-Probe®  
Kit \$29.95  
Wired \$49.95  
VTVM #221  
Kit \$25.95  
Wired \$39.95

†Pat. #2,790,051



Dynamic Conductance  
Tube & Transistor Tester #666  
Kit \$69.95 Wired \$109.95  
Complete with steel cover & handle

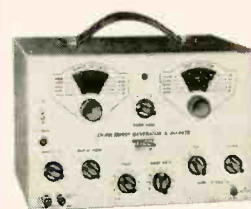

TV-FM Sweep Generator  
& Marker #368  
Kit \$69.95 Wired \$119.95

**BEST BUYS FOR INDUSTRIAL TESTING:** everything from Bridges to Supplies

NEW Metered  
Variable AC  
Bench Supplies:  
#1073 (3 amp.)  
Kit \$35.95  
Wired \$47.95  
#1078 (7½ amp.)  
Kit \$42.95  
Wired \$54.95



NEW Extra-Low-  
Ripple 6 &  
12 Volt  
Battery  
Eliminator  
& Charger #1064  
Kit \$43.95  
Wired \$52.95



R-C Bridge  
& R-C-L Comparator #950B  
Kit \$19.95 Wired \$29.95



1350 Combinations!  
Series/Parallel R-C  
Combination Box #1140  
U.S. Pat. No. 2954518  
Kit \$13.95 Wired \$19.95

**BEST BUYS IN STEREO & MONO HI-FI:** everything from Tape Decks to Speakers

Transistorized  
Stereo/  
Mono  
4-Track  
Tape  
Deck  
Wired  
Model  
RP100W  
\$395.00  
Semi-Kit  
Model  
RP100K  
Electronics in Kit form \$239.95

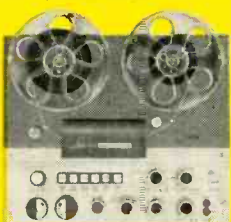

An original, exclusive EICO product  
designed and manufactured in the  
U.S.A. (Patents Pending)



NEW FM-AM Stereo Tuner ST96  
Kit \$89.95 Wired \$129.95 Inc. FET

NEW 70-Watt Integrated  
Stereo Amplifier ST70  
Kit \$94.95 Wired \$149.95



NEW 40-Watt Integrated  
Stereo Amplifier ST40  
Kit \$79.95 Wired \$129.95



Bookshelf Speaker System HFS1  
Kit \$39.95 Wired \$47.95

**BEST BUYS IN "HAM" GEAR:** from Transmitters to Code Oscillators



NEW 60-Watt CW Transmitter #723  
Kit \$49.95 Wired \$79.95



90-Watt CW Transmitter #720  
U.S. Pat. No. D-184776  
Kit \$79.95 Wired \$119.95



Universal Modulator Driver #730  
Kit \$49.95 Wired \$79.95  
Cover E-5 \$4.50

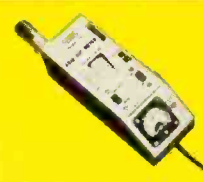

Grid Dip Meter #710  
Kit \$29.95 Wired \$49.95

Over 2 MILLION EICO instruments in use. Compare EICO side-by-side critically with products selling for 2 or 3 times more. Buy your EICO right "off the shelf" from 1500 neighborhood dealers coast to coast, most of whom offer budget terms.

**BEST BUYS IN CITIZENS TRANSCEIVERS AND TRANSISTOR RADIOS**



Over 80 unique  
products to  
choose from!

EICO, 3300 N. Blvd., L.I.C. 1, N.Y.

Send free 32-page catalog & Distributor's name.

Send Free Schematic of Model No.

Send new 36-page GUIDEBOOK TO HI-FI for which I enclose 25c for postage & handling.

Name \_\_\_\_\_

Address \_\_\_\_\_

City \_\_\_\_\_ Zone \_\_\_\_\_ State \_\_\_\_\_



NEW Deluxe  
Citizens Band Transceivers:  
#770: 117 VAC—  
Kit \$69.95 Wired \$99.95  
#771: 117 VAC & 6 VDC,\*  
#772: 117 VAC & 12 VDC\*—  
Kit \$79.95 Wired \$109.95

\*Including Posi-Lock®  
Mounting Bracket  
(PAT. PEND.)



Citizens Band Transceivers:  
#760: 117 VAC—  
Kit \$59.95 Wired \$89.95  
#761: 117 VAC & 6 VDC,\*  
#762: 117 VAC & 12 VDC\*—  
Kit \$69.95 Wired \$99.95



Transistor Portable Radio RA6  
Kit \$29.95—Wired \$49.95 Incl. FET

Listen to the EICO Hour, WABC-FM, N. Y. 95.5 MC, Mon.-Fri., 7:15-8 P.M.

Add 5% in the West © 1961 by EICO, 3300 N. Blvd., L. I. C. 1, N. Y.

# MAN INTO SPACE?

... *Electronic Robot into Space More Realistic* ...

FOR a number of years, the phrase *man into space* has been firing the public's imagination in a constantly accelerating tempo. Yet what does it mean?

Does it refer to an experimental rocket shot 50 to 100 miles up with a human passenger, then parachuting back to earth? Or does "man into space" go into orbit *above* the atmosphere, circle the earth once or a few times, then return to *terra firma*? Or does he circumnavigate the moon and perhaps land on it? The public does not differentiate between these steps; all it wants to know is *when* and *if* man does it.

As one who has constantly publicized spaceflight in his various magazines since 1911, the present writer must deplore the present wholly unscientific, costly uselessness of today's so-called "spaceflights."

For more than 50 years, practically every possible angle of mechanical flight into space has been studied and well understood—very little that is new has been added since Sputnik I.\* Rockets, their orbits, survival in the vacuum of space, weightlessness and its effects on man, rocket flight trajectories between other worlds—all were known and had been charted exactly by scientists. For nearly 50 years, most scientists have known that man would probably not be affected adversely by conditions found in space, including meteoroids, radiation and weightlessness. Since then, test animals have been shot above our atmosphere into space and returned unharmed.

Hence the totally unscientific present-day man-into-space propaganda-publicity has been deplored by many responsible scientists. Furthermore, practically all forward-looking Western spaceflight authorities know that today's rockets certainly will not be in use when regular interplanetary trips begin. Something much better will be used. It seems that the Russians have already made a start in that direction. Nuclear or similar power certainly will be the energy in use in all scheduled future spaceflights. With an abundance of power, landing on the moon (or other planets) and returning to the earth will present no problems—the "entry" difficulties now so much in the news will disappear, chiefly on account of adequate "retro-power."

The crying need today for the coming serious exploration of the moon is, not an unrealistic man-into-space experiment, but a full-scale expendable electronic auto-robot which will be an all-out pilot pioneer project. It will do far more than a man could ever hope to do, yet accomplish it much better, faster and over a much longer period.

A number of such automated machines have been described in space literature, but to the best of our knowledge none is sufficiently comprehensive in scope. Practically all recently proposed mechanical moon surveyors feature some solar cells, lunar drills, radio and TV camera and other

#### \*References

Konstantin E. Tsiolkovskiy. "... *Permanent observatory, to revolve around the earth beyond the limits of the atmosphere, like its moon*" (1895). Soviet Space Science. New York: Basic Books, Inc., 1959, p. XIII.

K. E. Tsiolkovskiy. "A space ship model realized from designs made in 1903 by pioneer rocket theorist Konstantin Tsiolkovskiy." Russian Science in the 21st Century. New York: McGraw-Hill Book Co., 1959, p. 150A.

Dr. Robert H. Goddard. *A Method of Reaching Extreme Altitudes*. Washington, D. C.: Smithsonian Miscellaneous Collections, Vol. 71, No. 2 (May 26) 1919.

Prof. Hermann Oberth. *Wege zur Raumschiffahrt* ("Roads to Space Travel"). Munich, Germany: R. Oldenbourg, 1928.

H. Gernsback. *RALPH 124C 41+* (A space novel serialized in 12 installments). *Modern Electric Magazine*, April 1911 to March 1912. New York: Modern Electric Publication.

(This article was written a month before April 12, the date of the first man into space event.)

elementary probes. Some proposed models are also mobile.

But far more is needed. Scientists, for instance, require *months-long* temperature records, radioed to earth every hour during all the phases of the moon. They have, from actual astronomical tele-bolometer observations, concluded that the moon's surface temperature varies between 220° F above and 250° F below zero. Careful and accurate measures over long intervals are necessary to give precise records to check the theoretical conclusions.

This in turn poses the question of power for the moon robot, once it starts functioning. Batteries alone are useless because they are too short-lived. We need *real* electrical power for our lunar drills, radio transmitter, TV camera and other instrumentation. We propose a reasonably large parabolic reflector, say 15 to 25 feet in diameter. Constructed like a folding umbrella, it takes little room in transit via rocket from earth to moon. On landing, it opens automatically, ready for work. *Half the inside of the reflector is polished aluminum, the other half covered with solar cells.* The solar cells give electrical current immediately when the reflector has turned automatically toward the sun. They then start charging the storage batteries. The reflector also focuses itself automatically into the best angle of the available sun's rays.

In the meantime, the heat rays of the reflector are concentrated on the focus that contains a mercury boiler. The resulting energy runs a high-efficiency electrical generator which also charges the storage batteries, giving sufficient electric power to tide over the electronic robot during the long lunar night. Thus we have two distinct sources of power.

There will also be an astronomical telescope which can be trained by telemetric control from earth toward many parts of the heavens. *Yes, it can be used day and night*, because even in daytime much of the lunar sky is black. A special TV camera sends the telescopic pictures earthward.

Aside from several dozen other necessary research instruments, we will mention only one, *a most important tool*, particularly for earth-weather research: One of the new supersensitive infrared detectors that can scan the slowly rotating earth constantly during our day and night, and will transmit at the same time an uninterrupted stream of vital cloud and heat information to our meteorologists.

Another innovation is necessary to safeguard the very important "soft" landing of the electronic robot. Retro-rockets alone, in our opinion, are not sufficient to soft-land such a heavy instrument-laden machine. Under each of the three large, padded feet of the robot there would be an automatic inflatable polystyrene balloon about 6 to 10 feet in diameter. A minute prior to landing, water (or other liquid) is injected into the folded balloons. Under the sun's fierce heat, the liquid evaporates quickly, fully inflating the tough 1/16-inch-thick walled balloons. This in addition to retro-rockets, will make a really soft landing possible. After the robot has settled on the moon, the balloons deflate automatically.

The weight of such a robot, despite its load of instruments, can be kept to under 500 lb. On the moon, this is only a sixth as much, or 83 lb.

Such an electronic explorer can be built today. It should be possible to rocket it to the moon within 3 years. It will be the most realistically needed "*yeoman into space.*"—H.G.

# YOU AND THE CB CITIZENS BAND

By **ROBERT F. SCOTT**  
TECHNICAL EDITOR

## What is the Citizens band?

The Citizens Radio Service, covered in Part 19 of FCC Rules and Regulations, provides for two bands of radio-frequency communications channels set aside to provide for personal short-distance communications, radio signaling and control of devices or models by radio.

Class-A Citizens radio stations operate on an assigned frequency in the 460-470-mc band with a maximum plate power input of 60 watts. They are authorized to operate as radiotelephone land stations, mobile stations or as base stations in a mobile network. Tone signals may be transmitted as aids to establishing or maintaining voice communications.

Class-A Citizens-band stations are not very popular because of the limited useful range, high cost and complexity of equipment.

Class-B stations in the Citizens radio service are mobile stations operating on the spot frequency of 465.00 mc with maximum plate power input of 5 watts. They may use AM, FM, or on-off unmodulated carrier for remote control and for radiotelephony.

Class-C stations are mobile units authorized for radio control of remote objects such as models, garage doors, electric water pumps, heaters, etc. or for remote operation of devices used solely as a method of attracting attention. They operate on 26.995, 27.045, 27.095, 27.145 and 27.195 mc with a maximum power input of 5 watts and on 27.255 mc with power input up to 30 watts. Operation is by tone modulation or on-off keying only.

The inauguration of class-D Citizens radio made the Citizens band what it is today. Frequency allocations in the vhf range of 26.965 to 27.255 mc provide greater communications range and simpler, more stable and less expensive equipment than the uhf class-A and -B authorizations.

Class-D stations are permitted to use amplitude voice modulation for radiotelephone communications only. Tone signals are permitted as aids to estab-

lishing and maintaining voice communications. (For example, see the detailed description of the signaling circuits used in Radson transceivers on page 54 of the September, 1960, issue.)

The following channels are available for class-D stations on a shared basis with no protection from interference from medical, scientific or industrial devices operating on 27.12 mc:

26.965 mc	27.065 mc	27.165 mc
26.975	27.075	27.175
26.985	27.085	27.185
27.005	27.105	27.205
27.015	27.115	27.215
27.025	27.125	27.225
27.035	27.135	27.255*
27.055	27.155	

\*Shared with stations in other services.

## Who can operate a Citizens-band receiver?

Any citizen of the United States who is 18 years old or older is eligible for a Citizens-band license. Persons under 18 may operate class-A, -B or -D Citizens-band equipment under the supervision of the licensee. For class-C stations (remote control) the licensee must be at least 12 years old.

## How can I get a Citizen-band license?

No test or examination is required for a license. Application is made by filling out FCC Form 505, available from the Federal Communications Commission, Washington 25, D.C., or from any one of the FCC Field Offices listed below:

Alabama, Mobile  
Alaska, PO Box 644, Anchorage  
PO Box 1421, Juneau  
California, Los Angeles 14  
San Diego 1  
San Francisco 26  
San Pedro  
Colorado, Denver 2  
District of Columbia, Washington 25  
Florida, PO Box 150, Miami 1  
Georgia, Atlanta 3  
PO Box 77, Savannah  
Hawaii, Honolulu 13  
Illinois, Chicago 4  
Louisiana, New Orleans 12  
Maryland, Baltimore 2  
Massachusetts, Boston 9  
Michigan, Detroit 26  
Minnesota, St. Paul 2  
Missouri, Kansas City 6  
New York, Buffalo 3  
New York 14  
Oregon, Portland 5  
Pennsylvania, Philadelphia 6  
Puerto Rico, PO Box 2987, San Juan  
Texas, PO Box 1527, Beaumont  
Dallas 2  
Houston 11  
Virginia, Norfolk 10  
Washington, Seattle 4

*Friends, students and experimenters have bombarded me with such questions as "How can I get a Citizens-band license?" "What is type approval?" "Can I build my own rig? What about this license-free Citizens band we hear so much about?" So I have tried to cover the pertinent points of CB and license-free radio in a question-and-answer style. I hope you like it and that I've answered the questions that have been puzzling you.*

## What is the difference between type-accepted and type-approved equipment?

Type acceptance and type approval are two classes of FCC certification specifying that the equipment so rated meets minimum technical specifications. Type approval is issued on the basis of tests performed in the commission's laboratory in Laurel, Md. Type acceptance is issued on the basis of technical specifications supplied to the FCC by the manufacturer or prospective licensee.

Type-acceptable equipment is listed in *Radio Equipment List, Part C*, available from the FCC in Washington, D.C., or from any of its field offices. Detailed specifications need not be submitted on crystal-controlled class-C or class-D equipment, provided the frequency stability is within FCC tolerances.

## Can I construct my own Citizens-band rig?

You may not construct your own class-A or -B equipment. You can construct class-D equipment from a kit supplied by a manufacturer who supplies all frequency-determining components prewired, aligned and sealed so that no frequency-determining component may be replaced nor any setting of any adjustment that may cause off-frequency operation be made without breaking the seal. Furthermore, the kit shall be designed so that excessive plate power input, overmodulation, excessive harmonic radiation or spurious signals are not possible with normal operation and adjustments. Manufacturers of kits or partially assembled units must certify to the purchaser (in writing) that the equipment has been designed, manufactured and furnished in accordance with FCC regulations.

You don't need a kit or prewired sub-assembly to construct class-C equipment for radio control only. Specifying crystal control on application Form 505 generally leads to automatic type acceptance. However, the commission may require you to certify that the frequency stability and tolerance of the crystal-controlled equipment are within 0.01% for 3 watts or less plate power input and .005% for higher plate power input.

## Can class-C radio control equipment be used in a class-D station?

Yes. Class-C equipment can be used



Four typical low-power Citizens band transceivers. From left to right: Heathkit GW-30; Ross Pocket Talkie; Globe Pocket phone; WE Phone.

to throw a relay or ring a bell to call you to the class-D transmitter or receiver. For example, assume that you have a class-C installation on a large ranch or similar area where signals are generally weak and may not be strong enough to be heard easily or strong enough to open the receiver's squelch circuit. In this case, you can use a 30-watt (maximum power permitted only on 27.255 mc) class-C rig to call attention to the fact that you want to contact the class-D station.

**Who can service CB transceivers?**

Any qualified radio service technician can service and adjust the receiver portions of a CB transceiver. When transmitting circuits affecting frequency stability or tolerance, harmonic radiation or modulation percentage are operating contrary to technical regulations, any repairs and adjustments must be made by, or under the immediate supervision of, a first- or second-class radiotelephone licensee. The operator making the repairs or adjustments shall be responsible for proper functioning of the equipment.

**Can I install Citizens-band radio in my power boat?**

Yes, you can use CB radio sets on

boats. Note well that Citizens radio does not replace, and is not a substitute for, regular marine radio equipment. Its range is generally shorter, interference is likely to be greater, and there are no continuously monitored distress or emergency channels.

**Can I talk to any station that I can hear?**

Citizens radio communications are generally restricted to contacts between two stations or units under the same license. You are authorized to talk to other stations only to exchange messages relating to personal or business affairs of the parties concerned. For example, you may contact another station to report an automobile accident in a remote area, make reservations at a motel or ask directions while motoring around the country.

Except when the communication involves immediate safety of life or property or civil defense, the exchange of communication between two stations (two licensees) shall not exceed 5 consecutive minutes and shall be followed by a silent period of at least 2 minutes. This gives other stations a chance to use the channel. During and after each silent period, both stations must moni-

tor the channel to make sure that it is not in use.

**I've seen ads of Citizens-band transceivers that do not require a license of any kind. What is the story here?**

Several manufacturers have developed transistorized radiotelephone transceivers for low-power class-D Citizens radio service. By limiting output to 100 milliwatts, and the maximum antenna length to 60 inches, they have certified their transceivers for use without license under the low-power rules.

You may use any number of these units in a net around the home, farm or business. However, you cannot contact licensed Citizens-band stations and you must not cause interference to any licensed radio service. On the other hand, you can use one of these 100-mw rigs on the Citizens band if it is included as one of the units listed on your CB license.

**Just what are the "low-power" rules and how do they affect the experimenter?**

"Subpart E—Low Power Communications Devices" of Part 15 of the FCC Rules provides for operation of wireless microphones, phono oscillators, garage-

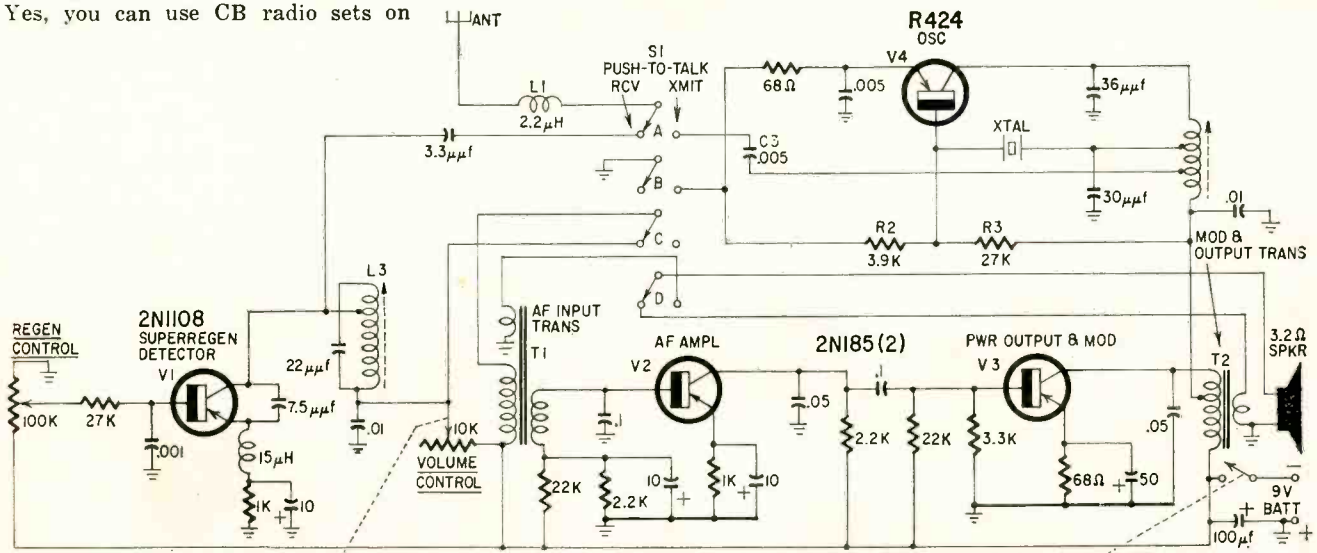

Circuit of the Heathkit GW-30

door operators and remote control of models. Bands available for this purpose are 10 to 490 kc, 510 to 1600 kc, 26.97 to 27.27 mc and frequencies above 70 mc. Below 1600 kc and above 70 mc, there are strict restrictions on radiated field strength.

From 10 to 490 kc, the field strength in microvolts per meter shall not exceed a figure equal to 2,400 divided by the operating frequency in kc at a distance of 1,000 feet. In lieu of meeting this radiation limitation, low-power communications equipment operating between 160 and 190 kc must (a) not exceed 1 watt plate power input to the final stage, (b) have an antenna whose total length (including transmission line) does not exceed 50 feet, (c) suppress all emissions outside this band at least 20 db below the unmodulated carrier.

In the broadcast band (510 to 1600 kc), field strength in microvolts per meter at 100 feet shall not exceed 24,000/F (kc). As an alternative, the plate power input to the final stage shall not exceed 100 mw, the total length of the antenna shall not exceed 10 feet, and emissions outside the band must be suppressed at least 20 db below the unmodulated carrier. Furthermore, if the device operates from a public-utility power source, the rf voltage measured from each side of the power line to ground shall not exceed 200 microvolts, both with the equipment grounded and ungrounded.

Between 26.97 and 27.27 mc—this range covers channels 2 through 23 of the class-D Citizens band—power input to the final rf stage shall not exceed 100 mw, the antenna must not be longer than 60 inches, and all emissions, including modulation products, must be at least 20 db below the unmodulated carrier.

Unlicensed low-power operation above 70 mc is permitted when operation is limited to 1-second duration and not more than once in 30 seconds. The equipment must be fitted with a device that automatically limits operation within these time restrictions. Maximum radiated field strength ranges from 50 to 500 microvolts per meter at 100 feet, depending on the exact frequency.

Note that any low-power communication device made after June 30, 1958, shall bear a certificate indicating that it meets FCC specification. The certificate may be prepared by the manufacturer or a technician skilled in making and interpreting the measurements that are required for compliance with FCC regulations. It shall state the operating conditions under which the equipment is to be used, the type and length of antenna and shall certify that the equipment complies with FCC requirements.

Briefly, as we see it, operating a home-constructed wireless microphone, phono oscillator, radio-controlled model, garage-door operator or other similar device is now illegal unless it has been certificated by the holder of a first- or second-class radiotelephone or radiotelegraph operator's license. Fees for performing the measurements required

for certification are likely to far exceed the saving realized in building your own equipment rather than purchasing it fully assembled and certificated.

Authorization to use a low-power communications device is given on the assumption that you will not cause interference to any licensed radio service. Your wireless mike or phono oscillator shall not interfere with reception of any licensed radio station. For example, if you are using the 27-mc band for remote control of a model plane or boat under the low-power rules, and a licensed Citizens-band operator starts to work with a model boat or plane in the same lake or field, you must stop operating if your signals interfere with his operation.

### **What are these low-power units like? Are they cheaper than regular Citizens-band equipment?**

Low-power transceivers range from a \$32.95 four-transistor kit with a superregenerative detector, to \$150 for 10- and 12-transistor types with superhet receiver circuits featuring adjustable squelch, noise limiters and other extras.

The diagram and photo show the Heathkit GW-30 certificated for use under Parts 15 and 19 of *FCC Rules and Regulations*. The GW-30—a four-transistor unit purchasable in kit form—is controlled by a combination ON-OFF switch and volume control on the front panel and a push-to-talk switch on the side. With normal intermittent use, it operates approximately 75 hours from its 9-volt NEDA type 1602 battery. Battery drain is approximately 12 ma when receiving and 22 ma when transmitting. Case dimensions are 6½ x 3¼ x 2¾ inches. Weight is 2 pounds. The transceiver uses a 40-inch whip antenna that telescopes to 6 inches.

The receiver—a three-transistor superregenerator—is fixed-tuned—by internal adjustment—to any one of 23 Citizens-band channels. The transmitter is crystal-controlled on CB channels 2

through 23 for unlicensed operation under the low-power rules and on CB channels 1 through 23 for licensed operation.

### **Circuit analysis**

The diagram is shown with the PUSH-TO-TALK SWITCH (S1) in the receive position. The antenna and loading coil L1 are coupled to receiver coil L3 through a 3.3- $\mu$ f capacitor that minimizes capacitive loading of the antenna and reduces radiation from the detector. The receiver is tuned to the desired channel by adjusting the slug in L3. The af output of the detector is fed through the high-impedance primary of the input transformer (T1) and audio amplifier V2 and V3 to the speaker.

When transmitting, S1-c opens the circuit between T1's high-impedance primary and the end of L3 to disconnect the detector from the audio amplifier. The transmitter's rf section consists of a R424 (Heath type number) transistor in a modulated oscillator circuit, with V2 & V3 acting as speech amplifier and modulator. S1-a switches the antenna to a tap on the transmitter tank coil through blocking capacitor C3. S1-b grounds the emitter and end of the base-bias voltage divider (R2-R3) so V4 operates as a class-C oscillator. S1-d switches the speaker from the secondary of T2 to the 3.2-ohm primary of input transformer T1.

Sounds picked up by the microphone are amplified by V2 and V3 to develop an audio voltage across T2's primary. This varying audio voltage is taken off a tap on T2 and used to modulate V4. The tap is set so modulation cannot exceed 100%.

More detailed information and answers to other questions on low-power communications and Citizens-band equipment is contained in Parts 15 and 19 in Vols. II and VI of *Rules and Regulations*, available from the Superintendent of Documents, US Government Printing Office, Washington 25, D.C., for \$2 and \$1.25, respectively. END

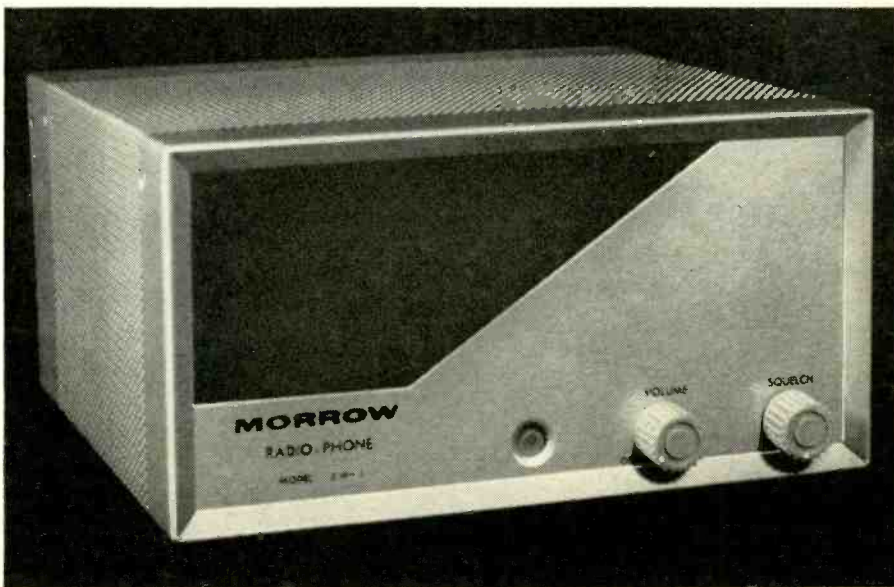

**The 5-watt Morrow radio phone.**

Four ranges measure capacitances between 0 and 0.1  $\mu\text{f}$  accurately

**BUILD**

2 transistor direct-reading

# CAPACITANCE METER

By RUFUS P. TURNER



**Q**UICK, direct reading of capacitance is a great convenience. A number of microfarad meters have been designed for this purpose, one of the most popular and foolproof of the recent ones being the multivibrator type (example, Heathkit CM-1).

Transistorizing this kind of capacitance meter gives us several advantages. The most important is complete portability (no power-line connection). Others are instant operation (no warm-up), power economy, cool operation and lighter weight than vacuum-tube instruments.

The instrument described in this article has four direct-reading capacitance ranges: 0–200  $\mu\text{f}$ , 0–1,000  $\mu\text{f}$ , 0–0.1  $\mu\text{f}$  and 0–0.1  $\mu\text{f}$ . The lowest capacitance which may be accurately read, on the lowest range, is 4  $\mu\text{f}$  (2  $\mu\text{f}$  may be estimated).

Any type of nonelectrolytic capacitor can be checked. No null balance or adjustments of any kind (other than setting the range switch) are required: simply connect the capacitor to the input terminals and read the capacitance from the meter. The instrument checks variables as well as fixed capacitors; the meter deflection will follow the capacitance change as you tune a variable unit.

The unit's maximum battery drain is 9.5 ma on the two high-capacitance ranges, and 3.2 ma on the two low-capacitance ranges, from four 1.5-volt size-D flashlight cells connected in series. At the highest current drain, the instrument could be used 8 hours a day for more than a month before a battery change would be needed.

## How it works

Fig. 1 is the basic circuit of the capacitance meter. In this arrangement, the two transistors (V1 and V2) are connected in a conventional cross-coupled multivibrator circuit. The multivibrator output taken from V2's collector is a constant-amplitude square wave whose frequency is determined principally by the values of C1 and C2 (which are identical) and R2 and R3 (also identical).

The square-wave output is coupled through the unknown capacitor,  $C_x$ , to the meter circuit consisting of diode D, rheostat R5, and dc microammeter M. For a given square-wave frequency, the microammeter deflection is directly proportional to capacitance  $C_x$ . Thus, if an accurately known capacitance (say  $C_s$   $\mu\text{f}$ ) is connected temporarily to terminals X–X and R5 is set for full-scale deflection, the meter will then have a range of 0 to  $C_s$  microfarads. Response is linear, so half-scale deflection indicates a capacitance of  $\frac{1}{2}C_s$ , one-tenth of full scale 0.1 $C_s$ , and so on. To change capacitance range, the multivibrator frequency must be changed (by switching in new values of C1, C2, R2 and R3) and resetting CALIBRATION control R5. The higher the frequency, the lower the capacitance range, and vice versa.

## Final circuit design

Fig. 2 is the complete circuit diagram for the instrument.

In this arrangement, the approximate operating frequencies are 50 kc for range A (0–200  $\mu\text{f}$ ), 5 kc for range B (0–1000  $\mu\text{f}$ ), 1,000 cycles for range C (0–0.1  $\mu\text{f}$ ) and 100 cycles for range

D (0–0.1  $\mu\text{f}$ ). To switch frequency, the values of the cross-coupling capacitors (C1 to C4 and C5 to C8), base resistors (R2, R3 and R4, R5) and CALIBRATION controls (R7, R9, R11 and R13) are changed simultaneously. Experiment showed that the battery voltage must be increased to 6 volts when going to the .01- and 0.1- $\mu\text{f}$  ranges.

No zero adjustment is required. Even when the instrument is on, the pointer of the meter rests on zero until a capacitor is connected across J1 and J2. The CALIBRATION controls are set once and need not be touched again unless the instrument is being recalibrated.

## Construction and wiring

There is no best way to build the capacitance meter. The instrument design is straightforward and the circuit operation is reasonably free of bugs, therefore the reader may suit himself as to layout.

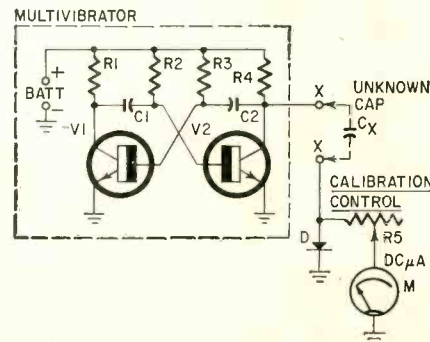
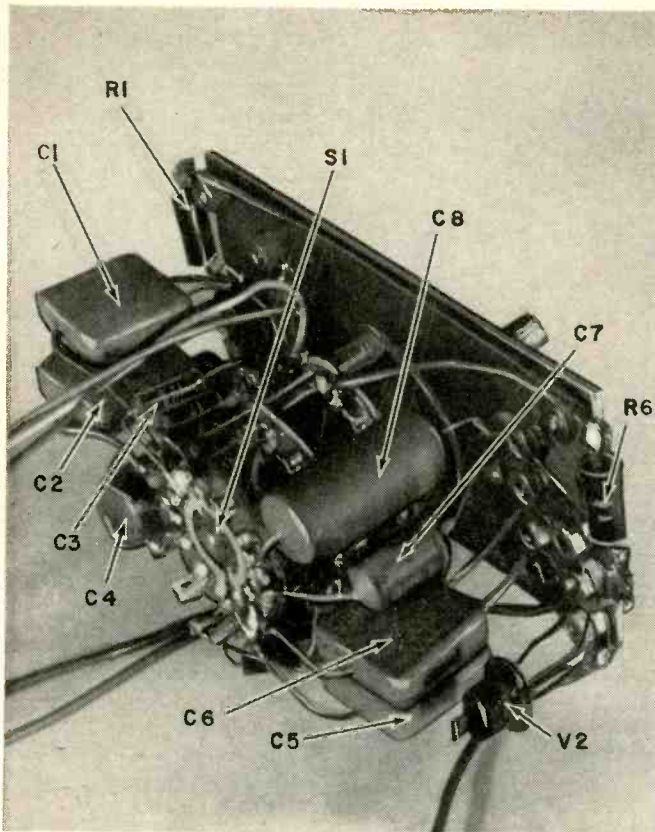
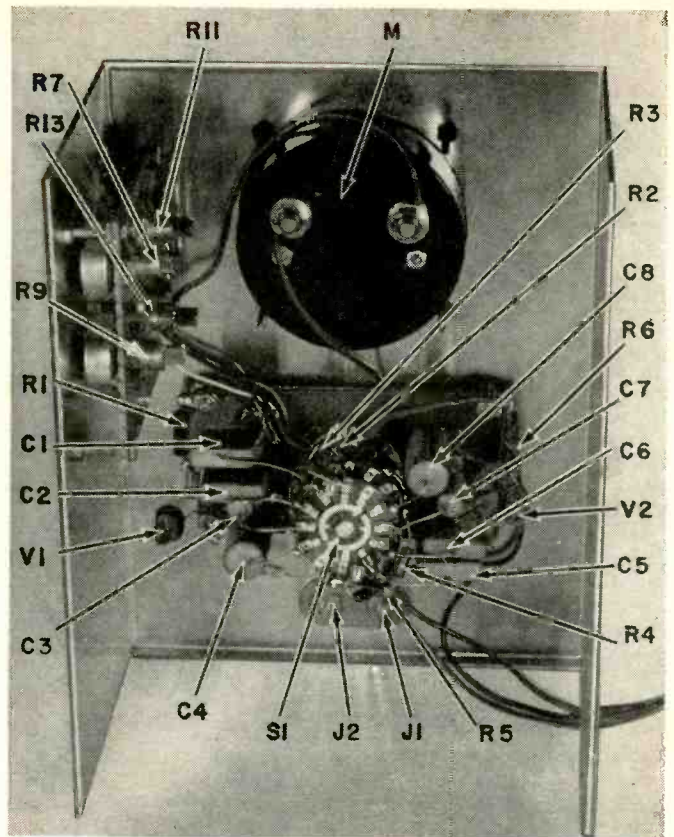

Fig. 1—Basic capacitance-meter circuit.



Most components are mounted on the perforated board that mounts the range switch.



Inside the case. Note how the range-switch board is mounted. Also the calibration pots on the left.

A lot of wiring simply consists of connecting the capacitors and resistors to the range switch. First, fasten the switch to a 4 x 2 x 1/16-inch phenolic subpanel. Bolt solder lugs (with 1/4-inch 6-32 screws and nuts) at various points for connecting component leads.

After wiring is completed, mounting the range switch to the front panel fastens the circuit board to the latter. Mount the four calibration controls (R7, R9, R11 and R13) next, with their limiting resistors (R8, R10 and R12), on a 3 x 3-inch phenolic subpanel held by four 1-inch 6-32 screws to one side

wall of the box. Their shafts must be slotted for screwdriver adjustment. Clip the four flashlight cells into two battery holders bolted to the floor of the box.

Keep the capacitance between the capacitor test terminals low, or the meter will indicate this capacitance on its low range. I used a National type FWH terminal strip. This unit spaces the two binding posts 3/4 inch apart and requires a 5/8-inch diameter clearance hole for each screw. If you use regular insulated binding posts, mount them at least 3/4 inch apart on a plastic strip, and cut 5/8-inch diameter clear-

ance holes for their screws in the metal panel.

The meter scale may be used as is (few mental gymnastics are required to convert its deflections into microfarads on sight, even on the 0-200- $\mu$ f range) or a new scale may be drawn, reading directly in  $\mu$ f and  $\mu$ mF.

### Calibration

To calibrate the instrument you will need four accurately known capacitors—0.1  $\mu$ f, .01  $\mu$ f, 1,000  $\mu$ mF and 200  $\mu$ mF. You can use any capacitors having these values but the accuracy of the instru-

Fig. 2—The completed instrument. Note, the basic multivibrator circuit is still used.

- R1, R6—1,000 ohms
- R2, R4—20,000 ohms, 5%
- R3, R5—5,100 ohms, 5%
- R7—pot, 10,000 ohms, miniature (Centralab B-14 or equivalent)
- R8—5,600 ohms
- R9—pot, 5,000 ohms, miniature (Centralab B-10 or equivalent)
- R10—22,000 ohms
- R11, R13—pot, 25,000 ohms, miniature (Centralab B-26 or equivalent)
- R12—10,000 ohms
- All resistors 1/2-watt 10% unless noted
- C1, C5—500  $\mu$ mF, mica
- C2, C6—.002  $\mu$ f, mica
- C3, C7—0.1  $\mu$ f, 200 volts, miniature metallized tubular
- C4, C8—1  $\mu$ f, 200 volts, miniature metallized tubular
- BATT—6 volts, 4 1.5-volt D-cells in series with tap at 3 volts
- D—IN34
- M—0-50  $\mu$ a, dc
- S—6-pole, 3-deck, 5-position, nonshorting, rotary selector switch (Centralab PA-1021 or equivalent)
- V1, V2—2N168-A
- Case, 8 x 6 x 4 1/2 inches
- Battery holders
- Miscellaneous hardware

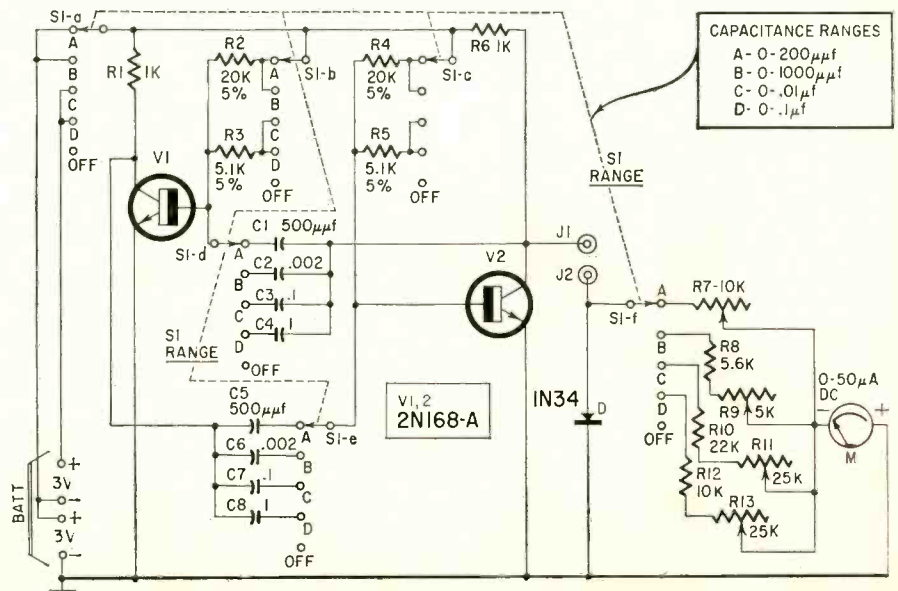



ment depends upon the tolerance of these calibration capacitors. In addition to having close tolerance in capacitance, they must not be leaky.

Follow this procedure: (1) With the range switch in its OFF position, connect the 0.1- $\mu\text{f}$  calibration capacitor to the test jacks, using the shortest possible leads. (2) Throw the range switch to range D. (3) Adjust R13 for full-scale deflection of meter M. (4) Disconnect the 0.1- $\mu\text{f}$  calibration capacitor. (5) Connect the .01- $\mu\text{f}$  calibration capacitor to terminals J1, J2, using the shortest possible leads. (6) Throw the range switch to its range C and continue as in steps (3) and (4), adjusting the appropriate calibration control. Continue through all other ranges in the same way.

### Use of instrument

The instrument has been protected against damage by arranging the sequence of range-switch positions so the first position after the instrument has been switched on is the highest-capacitance range. When the instrument is switched off from any of its lower ranges, the switch must be rotated through the high-capacitance ranges.

Electrolytic capacitors cannot be checked. The instrument will check all other types.

To use the instrument: With the range switch in its OFF position, connect the test capacitor to the test terminals using the shortest possible leads. Throw S1 to range D and read the capacitance from the meter. If the indication is too low on the scale for accurate reading, switch to range C. If it is still too low, switch to range B or A. Throw S1 to OFF. Disconnect the capacitor.

When a large number of capacitors must be checked, the instrument may be left switched on and the capacitors checked by touching their pigtailed to the terminals.

Most continuously variable capacitors have their maximum capacitance in either range A or range B. To check a variable capacitor, set the capacitor to its maximum capacitance. With S1 in its OFF position, connect the capacitor to the test terminals, using the shortest possible leads. Set S1 to range B. Read the capacitance from the meter. If the indication is too low on the scale for accurate reading, switch to range A. Tune the capacitor through its range, noting that meter deflection follows the tuning and shows the capacitance at each setting of the variable capacitor. Throw S1 to OFF. Disconnect the variable capacitor.

If a capacitor is open, there will be no deflection on any range. If a capac-

itor is leaky or shorted, the meter will deflect sharply down from zero. *Disconnect a leaky or shorted capacitor immediately, since it connects the meter circuit of the instrument to the positive collector voltage of transistor V2, and may damage the diode or microammeter.*

END

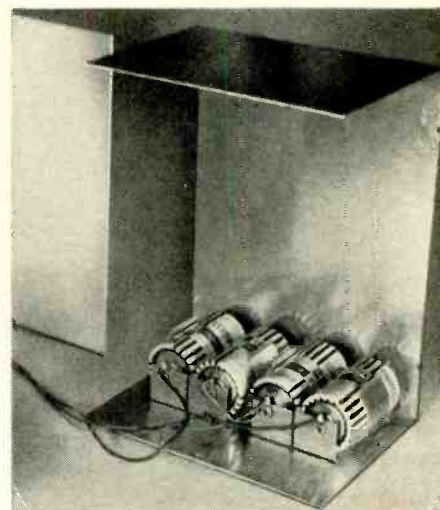

Detailed look at the battery mounting.

# Stacked-B Trouble

By LAWRENCE SHAW

Many TV sets have a stacked-B supply. The audio output tube acts as a voltage dropping resistor for the low B-plus. Tubes used in the audio output stages have had the bad habit of short-circuiting ever since radio started. In a simple circuit, we just replace the tube when this happens. Or, maybe, afterward we find that a new output transformer is needed also.

In the stacked-B system, simple tube replacement may cause still more damage if defects caused by the prior short have not been corrected. We can dam-

age or destroy the new tube, a capacitor, power supply, or parts associated with it.

For example, Fig. 1 is the partial schematic of a stacked-B circuit. Here we have a 12C5 serving as the audio output as well as the dropping resistor from 255 to 135 volts. A 100- $\mu\text{f}$  150-volt electrolytic (C1) bypasses screen and plate supply to the cathode, which is the 135-volt line. Another 100- $\mu\text{f}$  150-volt unit (C2-a) bypasses the 135-volt line to ground. In the same can is C2-b, a 150- $\mu\text{f}$  300-volt unit that bypasses the 255-volt line to ground.

In normal operation, we have what we see in Fig. 2-a. Screen and plate of the output tube act as a resistor dropping 215 to 135 volts. If the output tube develops a plate-to-cathode short as in Fig. 2-b, the 135-volt bypass C2-a will probably blow because of the 215 volts impressed on it.

C2-b is in the same can and, when C2-a goes, it may blow too. If the set is turned on again with C2-b shorted, the power supply may give up the ghost. The probable component to go is the choke (see Fig. 2-c). So check

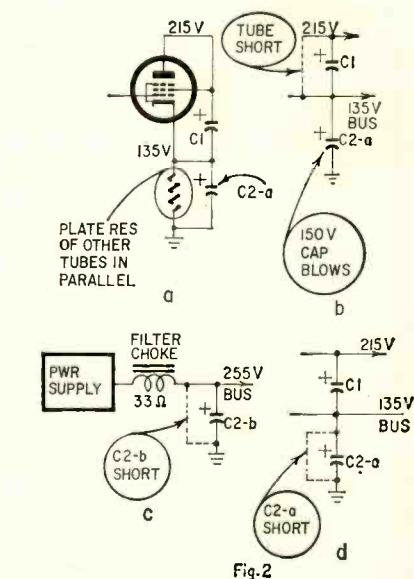

Fig. 2

for a possible short or low resistance from the 255-volt line to ground across C2-b.

Inserting a new tube and turning the set on without checking for a possible short in C2-a may result in the situation shown in Fig. 2-d. The minus side of C1 will be at ground potential if C2-a shorts. It is a 150-volt unit and will not take 250 volts very long. So check for a short across C2-a before inserting the new tube. And check C2-b if C2-a is shorted.

END

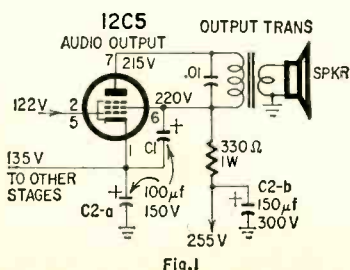

Fig. 1

# don't forget the ANTENNA

*Check it on every call.*

*It may be causing that snowy picture*

By **ARTHUR CUNNINGHAM**

**O**NE important item too often overlooked when checking a TV set for snow, poor pictures or almost everything else is the antenna. After all, a Jaguar won't run very far nor very fast without "petrol," and you can't expect even the most sensitive TV set to make much of a picture without an input signal.

So check the antenna as a matter of course on every service job. See that it's aimed at the station, that the lead-in's OK, all connections are tight and most important of all, that it's the proper kind of antenna for the area.

Once a familiar item, the TV field-strength meter seems to have about disappeared, and it sure shouldn't have! You can make some awfully quick and

useful checks with one. For instance, if the picture is snowy, before tearing up the tuner, hook the lead-in to the field-strength meter. A reading of about 40 to 50  $\mu\text{v}$  means that the tuner is OK. (In fact, it's darn good if it makes a picture at all with such a low input.)

After a few tests, you'll know what the average signal strength from each station in your area should be, on any given type of antenna. You'll be able to tell pretty quickly whether the set or the antenna is at fault. For instance, if there's a Yagi on the roof and the signal reads only about 30  $\mu\text{v}$  where it should normally read 200  $\mu\text{v}$ , you can usually bet that the lead-in's open somewhere. Other tests are just as simple.

### Signal areas

The area where the antenna is used

is most important. Fig. 1 shows the general classifications of TV antennas suitable for use at varying distances from the transmitter. However, like all others, this rule will not hold true at all times. Now and then you'll find a simple conical sitting on a chimney and calmly delivering excellent pictures 40 or 50 miles from a transmitter. This is due to some freak of reception. The signal field at this one particular point is far above the norm for the area. For a practical example, the range of high-channel stations is considered shorter than for low channels, but one location picks up very good signals from a channel 8 station over 200 miles away. Impossible? Certainly it's impossible, but don't mention it to my antenna, because it's the one that's doing it!

One major source of trouble shows

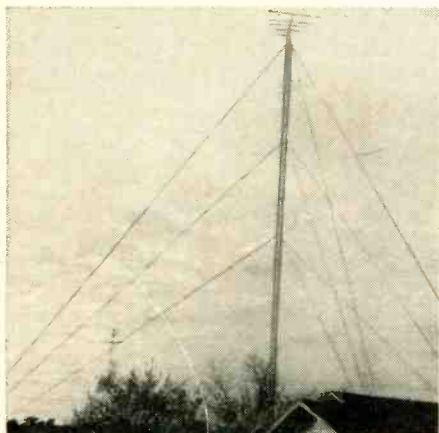

Towers as high as this one (90-footer) are not needed, except in very special cases.

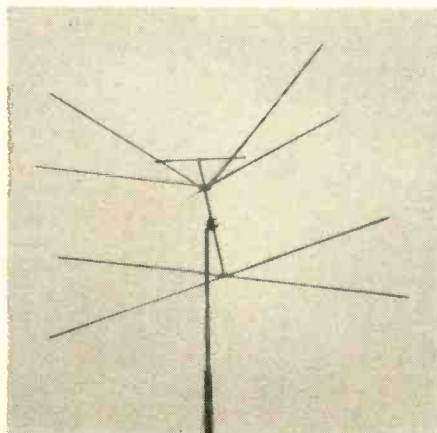

The conical. Perhaps the most popular antenna in numbers because of its broad-band characteristics. Not recommended for fringe use.

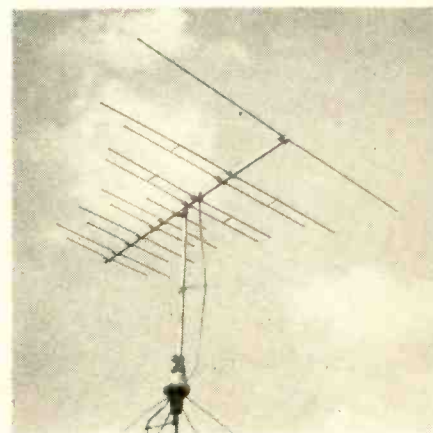

A highly efficient all-channel antenna suitable for fringe use. Gain from 9 to 12 db and excellent front-to-back ratio.

up when a family moves from a metropolitan area to a fringe. Almost invariably they lug their city antenna with them, install it and start complaining. "Why can't we get good TV here? Must be something wrong with the set!"

There is actually one more factor in this situation. In very-strong-signal areas it is possible for the operating condition of the TV set to deteriorate quite badly before it shows up in the picture. A set which has been used for 2 or 3 years and is moved to a weak-signal area will often require as many as seven or eight new tubes, much to the owner's dismay and disbelief. They have gone weak with age but, due to the high signal level in the original location, actually did not affect reception perceptibly. Out in the fringe, everything must be up to par. Any weakness shows up immediately as poor reception.

Also, radiation patterns of TV transmitters are far from being the neat round circles usually drawn on a map. Fig. 2 is the actual pattern of one station. Originally, with about 27-kw ERP, it came into City D with excellent pictures. However, the station increased its power and the signal vanished. The explanation is shown. The antenna was retuned to concentrate the maximum signal on Cities B and C, both large population centers where the station derived a great deal of advertising revenue. This left D out in the cold, with a large group of angry viewers giving the local TV technicians a very thin time! "It increased power, didn't it? Well, then, why can't we get it?"

#### Antennas and gain

Antenna gain figures vary widely but generally you can expect something like this: conicals and dipoles, 2-3 db; conicals with reflectors, single-bay, 3-5 db; these antennas stacked, gain increased by about 1 db; Yagis, 5-element, 7 to 9 db.

In the last few years, some excellent fringe-area antennas have been designed, mostly using the Yagi configuration, which covers all channels from 2 through 13 and have very good pat-

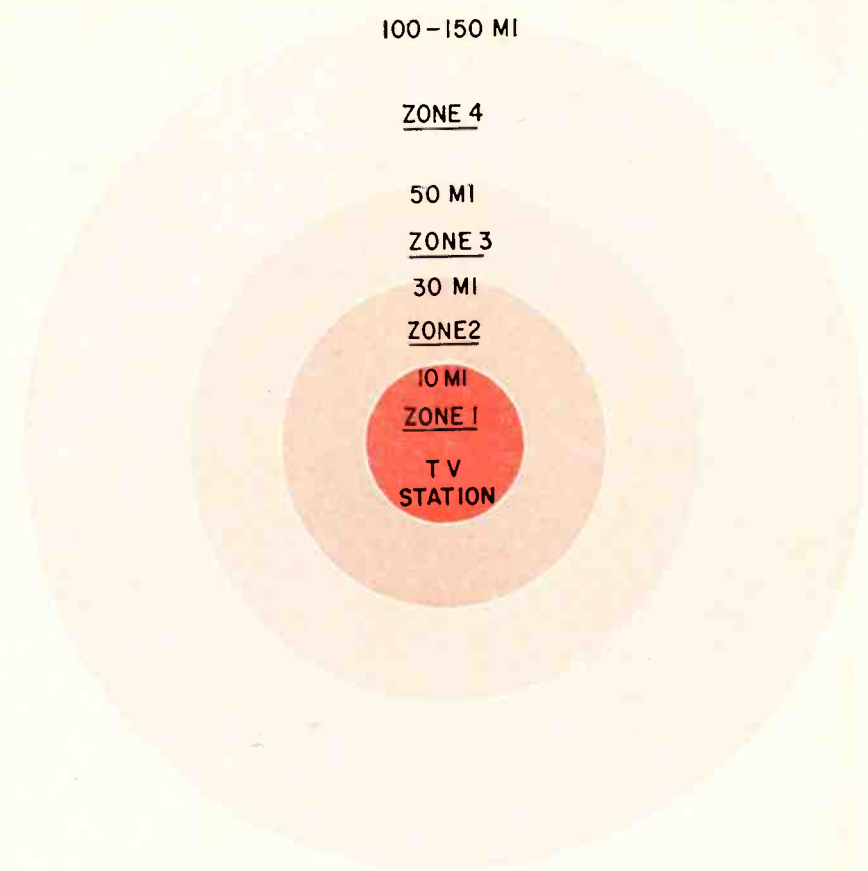

- ZONE 1—Rabbit ears, single-bay conicals, dipoles, built-in antennas
- ZONE 2—Dipole-reflector, 2-bay conicals
- ZONE 3—Dipole-reflector-director, 2- and 4-bay conicals with reflectors, 5-element Yagis, all-channel Yagis, dipole with director and screen-reflector combinations.
- ZONE 4—5- and 8-element Yagis, 8-element all-channel Yagis with antenna boosters

Fig. 1—TV reception area and suggested antenna types.

tern shapes. Most of them have a frontal lobe almost as narrow as the single-channel Yagi, which is very helpful in areas with co-channel interference.

To keep on generalizing, actual field tests have shown that the antennas which most closely resemble their parent Yagis seem to give the best results.

Another recent development is the traveling-wave antenna. This is an excellent type for very deep-fringe use,

especially when combined with a good antenna booster delivering about 20-25-db gain.

#### How high?

The height of a TV antenna above ground has been the subject of bitter controversy ever since the beginning. Unfortunately, many of the arguers have depended upon quoting from textbooks instead of going out and finding out for themselves!

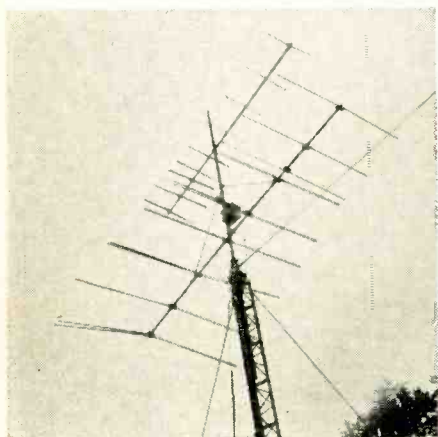

Author's own antenna. Longer lower unit covers low channels, small upper unit for highs. Note antenna booster mounted between the bays.

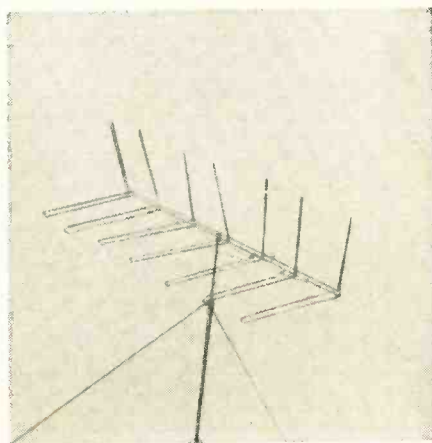

Latest version of the traveling-wave antenna. This 7-element type is very good for deep fringe-area work.

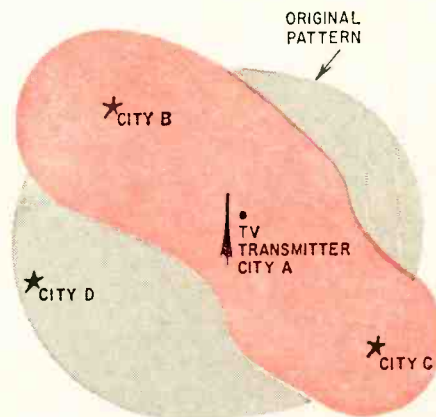

Fig. 2—Station increased power, but changed its antenna system. Put City D out of the TV picture.

# WHAT'S YOUR EQ?

We spent one very hot summer cranking antennas up and down on an adjustable tower to find the optimum height for TV reception in our area. The results were mildly astonishing. Contrary to the past dictum of "the higher the antenna the better the signal," we found that, above a maximum height of 30 feet, there was no perceptible increase in field strength! The minimum was 20 feet. Our nearest TV transmitter is 78 airline miles away. Other stations at 93 miles and 82 miles have since been added. Repeating the tests gave the same results. Of course, every area is different and there are exceptions.

For example, we are in a mountainous area and find some locations where we must go higher and others where we go lower. One location, directly behind a large mountain, gets very good pictures by pointing the antenna straight at the mountain. This is probably an extreme case of obstacle gain caused by the signal bending over the top of the mountain. Some TV viewers in this area have gone to extreme heights, but the results often won't justify the very high cost.

Incidentally, when pointing the antenna at the station, one rule always applies. The little end of an all-channel antenna is always the front; they're roughly triangular in shape. One little old lady among our customers bought a new TV set. The dealer's salesman installed it, put up an all-channel antenna and told her to point the antenna at whatever station she wanted. A week or so later, we got a hurry-up call—the new TV wasn't working right! Too much snow.

Rushing out to the house, we found out that once again the customer was right. Lots of snow! From force of habit we looked at the antenna and found it pointed directly away from the station (the big end toward the station). After we reversed the antenna and cleaned up the snow, we explained this to the customer. She said, "Oh my! I thought it was like a funnel and you had to point the big end at whatever you wanted to catch."

Incidentally, don't forget to check that lead-in with an ohmmeter, especially after a period of high winds. One conductor may have broken inside the insulation. All modern antennas, except the conicals, have continuity across the antenna element itself, due to the folded-dipole construction. A conical may be foxed up for this by connecting a 10,000-ohm resistor across the elements when installing the antenna. This will allow continuity readings to be made without lowering the antenna. As a final hint, if you find a broken lead-in, don't bother hunting for the break. Replace the whole line without further ado. Reason? If the line has been flexed by wind to the point where one conductor has parted completely, there are quite a few other places where the strands are almost broken and held by only a single wire. To avoid callbacks, replace the entire lead-in. It costs the customer only a couple of dollars.

END

Here we go again with a new group of three stimulating electronic problems. The first, like all service problems, may have more than one answer. The last one may also have more than one solution. But there is only one correct answer to the Voltage Jungle. Can you find the right solution to all three?

Answers to last month's problems are on page 104. We are using the author's solution for the photo-relay circuit as we received nothing in time to print here.

Send in your own original brain-teasers. We pay \$10 for each one published. Address Puzzle Editor, RADIO-ELECTRONICS, 154 W. 14 St., New York 11, N.Y.

## Service Stinker No. 2

**Symptoms:** Picture covers about three-quarters screen; very heavy vertical retrace lines. Vertical blanking bar locks firmly in center of screen. Vertical hold control has absolutely no effect at all on picture!

**Question:** Is the trouble in vertical hold control? Vertical retrace eliminator network? Vertical sync?—*Jack Darr*

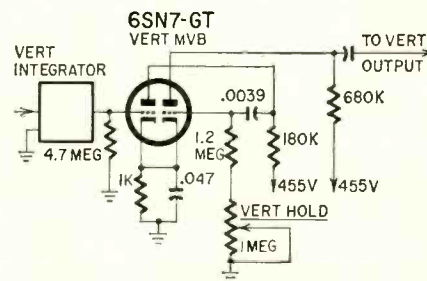

## Voltage Jungle

**W**ITH the supply voltage shown (115 volts), how many different voltages can you get with the transformer in the drawing? The voltages indicated for each winding would, of course, be the manufacturer's rating. The transformer windings can be connected any way you like (series aiding, opposing, etc.)—*Dellroye D. Darling*

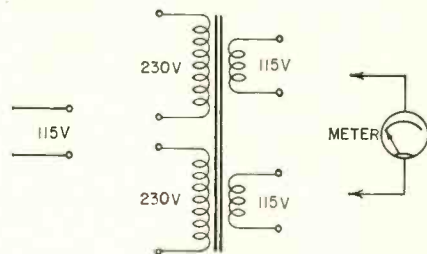

## Frequency-divider Puzzle

**A** 12-to-1 frequency divider is required to produce one output pulse for each dozen objects moving by on a conveyor belt. The objects on the conveyor are sensed by a phototube. A four-stage binary counter is available

and is to be modified so that it will produce an output pulse for every 12 input pulses (instead of every 16 input pulses as it normally would). What modification should be made in the binary counter?—*Ed Bukstein* END

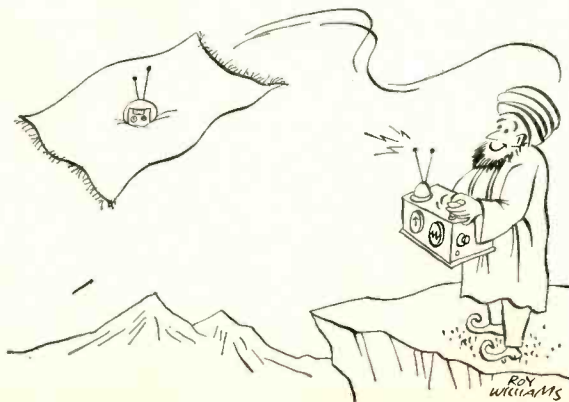

# build an ALL-TRANSISTOR ELECTRONIC CROSSOVER

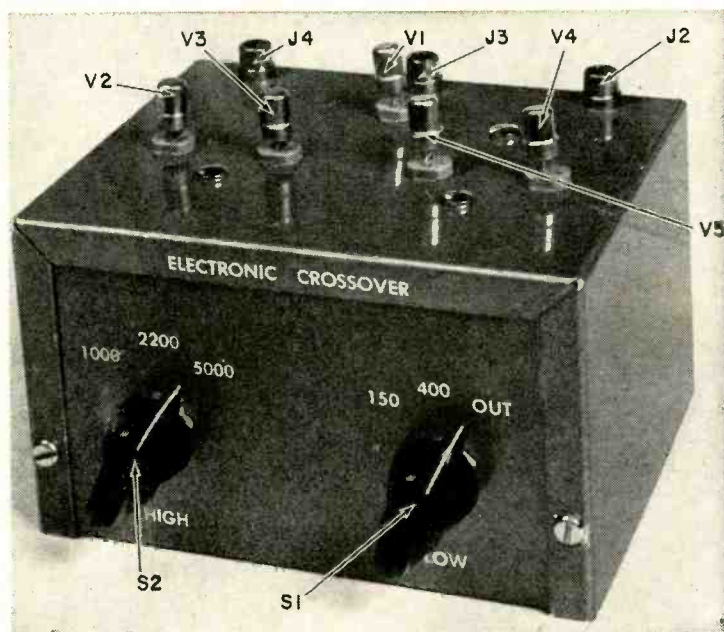

Front view of the completed crossover.

By DANIEL MEYER

Improve your stereo system; add a crossover that uses active filters and get more realistic sound

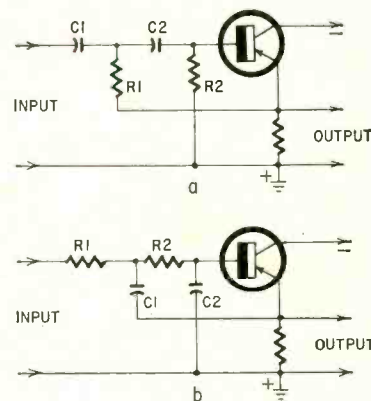

Fig. 1—Basic filter circuits: a—high pass, b—low pass.

frequency and the shape of the response curve at the corner frequency.\* An emitter-follower circuit was used to minimize temperature-sensitivity problems with the transistors. This circuit also has very low distortion due to the large amount of degeneration in each stage. In the basic high-pass circuit shown, R2 is equal to the resistance of three parallel resistors. These are the two bias resistors and the input resistance of the transistor. In the low-pass circuit, R1, R2 and the input resistance of the transistor form a voltage-divider network. For this reason, R1 and R2 must not have too high a value, or circuit losses will be excessive.

The complete circuit shown in Fig. 2 consists of an emitter follower driving

\*R. P. Sallen and E. L. Key, "A Practical Method of Designing R-C Active Filters," *IRE Transactions—Circuit Theory*, March 1959.

**E**VEN though the electronic crossover offers a definite improvement in high-fidelity installations, it has become a stepchild since the coming of stereo. This is without a doubt due to the number of amplifiers required in a stereo installation using this system, since an electronic crossover divides the frequency spectrum to be reproduced by each speaker *before* the power amplifier. However, there are several advantages:

► By eliminating the reactances used in conventional crossovers between the speaker and the amplifier, we greatly improve the amplifiers' control over the speakers' motions.

► Intermodulation distortion is reduced due to the narrower range of frequencies amplified by each amplifier.

► Less powerful amplifiers, and amplifiers most suitable for each speaker, may be used.

The last point is especially important in systems using electrostatic tweeters since these speakers present a capacitive load to the power amplifier. This can cause instability and in severe cases

even oscillation in amplifiers not designed to drive a capacitive load.

This circuit uses four feedback type filters to produce the attenuation past the crossover points. They are called active filters because amplification is needed for the filters to operate. The switching arrangement selects the desired crossover frequency and allows the circuit to be used with either a two- or three-way system. Crossovers at 1,000, 2,200 or 5,000 cycles can be selected with the two-way system. In addition, crossovers at 150 and 400 cycles are available if a three-way speaker system is to be used. The crossover points are selected with the two switches shown on the front of the unit. The basic high- and low-pass transistor active filter circuits shown in Fig. 1 are used to separate the various frequencies. These filters give 12-db-per-octave attenuation on each side of the crossover frequency. In each filter, the values of the four components shown in Fig. 1 (R1, R2, C1, C2) and the gain of the emitter follower all play a part in determining the corner

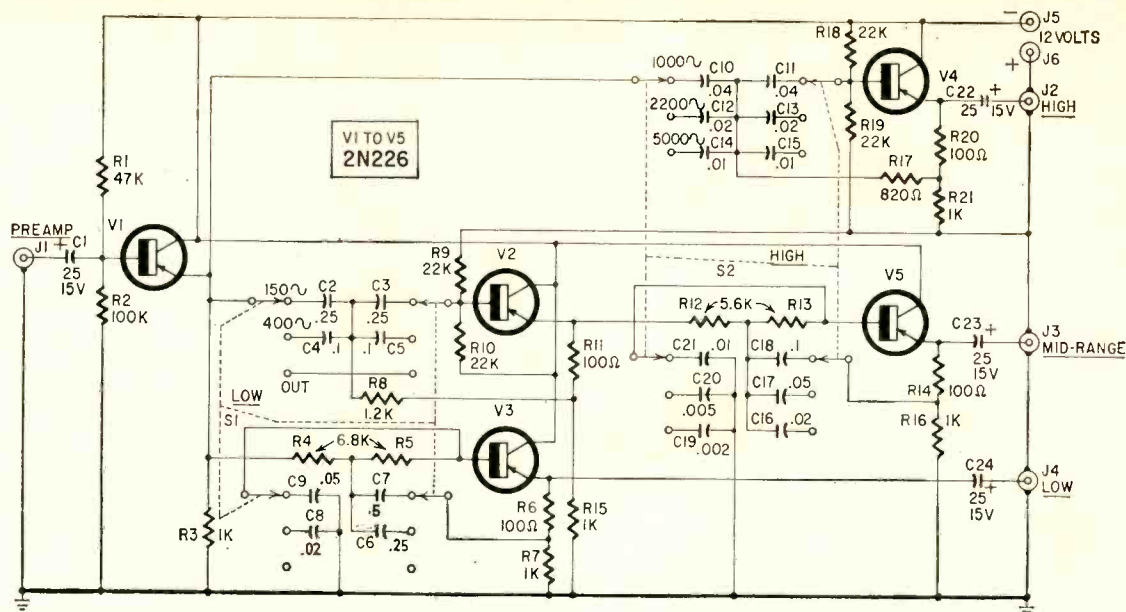

Fig. 2—The complete 5-transistor crossover circuit.

- R1—47,000 ohms
- R2—100,000 ohms
- R3, 7, 15, 16, 21—1,000 ohms
- R4, 5—6,800 ohms
- R6, 11, 14, 20—100 ohms
- R8—1,200 ohms
- R9, 10, 18, 19—22,000 ohms
- R12, 13—5,400 ohms
- R17—820 ohms
- All resistors 1/2-watt 10%
- C1, 22, 23, 24—25  $\mu$ f volts, electrolytic
- C2, 3, 6—0.25  $\mu$ f
- C4, 5, 18—0.1  $\mu$ f
- C7—0.5  $\mu$ f
- C8, 12, 13, 16—0.02  $\mu$ f
- C9, 17—0.05  $\mu$ f
- C10, 11—0.04  $\mu$ f
- C14, 15, 21—0.01  $\mu$ f
- C19—0.002  $\mu$ f
- C20—0.005  $\mu$ f

All capacitors 15 volts or higher, any type. All except electrolytics 10% tolerance  
 J1, 2, 3, 4—phono jacks  
 J5, 6—3-way binding posts  
 S1, 2—4-pole 3-position rotary switches (see text)  
 V1, 2, 3, 4, 5—2N226 (see text)  
 Case: 3 x 4 x 5 inches  
 Transistor sockets (5)  
 Miscellaneous hardware

a low-pass filter for the low range, a bandpass filter for the mid-range, and a high-pass filter for the high. The various crossover frequencies are produced by switching different-size capacitors into the circuits (C1 and C2 in the basic circuits). In the OUT position of the LOW selector switch, the circuit is converted into a two-way filter system in which the MID-RANGE output jack is used for the woofer portion of the speaker system, and the HIGH output jack for the tweeter portion.

### Construction

The crossover is built into a 5 x 4 x 3-inch aluminum utility box. The parts arrangement shown in the photographs is not critical, and almost any desired

layout or location may be used. It is important that 10% tolerance capacitors and resistors be used in the frequency-determining circuits. As can be seen in the photographs, various types of capacitors were used in the original unit. These were all checked for capacitance before they were installed. The selector switches are four-pole five-position types with an adjustable stop set to limit rotation to three positions. Use the switch lugs on the unused positions to mount components and as tie points. The transistors specified were selected on the basis of price and availability. Any audio-frequency transistor with a beta between 20 and 100 and reasonably low leakage should work equally well.

A battery power supply was used with the original crossover, but an ac supply would do just as well. Such a supply is shown in Fig. 3. It will deliver a low-ripple -9 to -12 volts suitable for powering the electronic crossover.

### Testing the equipment

Make sure you check the complete crossover for proper operation. Response at the various crossover points should follow the curves in Fig. 4. It is important that the -3-db points for the high- and low-pass filters coincide as closely as possible at each crossover point. If they do not, there will be holes or peaks in the speaker output, depending on whether the crossover was above or below the -3-db point.

If all the HIGH crossover points are slightly off, a variation in the value of R17 will shift them all slightly. Similarly, a variation in the value of R4 will shift the two LOW crossover points.

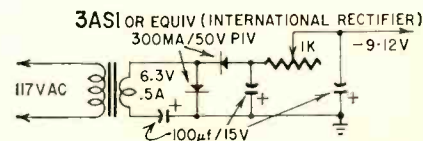

Fig. 3—This ac power supply can be used to power the crossover.

**BENCH**



**TESTED**

- Frequency Response**  $\pm 1$  db over any selected range (20-cycle lower and 20,000-cycle upper limits)
- Power Consumption** 9-volt supply: 18 ma  
12-volt supply: 25 ma
- Maximum input signal** 9-volt supply: 2 volts rms  
12-volt supply: 3 volts rms
- Gain** Measured with 12-volt supply. Source impedance 500 ohms; works into 500,000-ohm load. Input of 1-volt rms = 0 db.  
 Low Channel (measured at 100 cycles): -1.8 db  
 Mid Channel (measured at 1,000 cycles): -0.5 db  
 High Channel (measured at 10,000 cycles): 0.0 db
- Input Impedance** See Fig. 5
- Output Impedance** Less than 500 ohms on any channel
- Distortion** Measured with a 12-volt supply. Output level of 1 volt.  
 Low Channel (Measured at 100 cycles): .10% 2nd harmonic  
 .02% 3rd harmonic  
 Mid Channel (Measured at 1,000 cycles): .05% 2nd harmonic  
 .02% 3rd harmonic  
 High Channel (Measured at 10,000 cycles): .16% 2nd harmonic  
 .02% 3rd harmonic
- Hum and Noise** Measured with 9-volt supply. Crossover selector switches in 400- and 5,000-cycle positions. Figures are in db below 1-volt output on each channel  
 Low Channel: -82 db  
 Mid Channel: -80 db  
 High Channel: -85 db

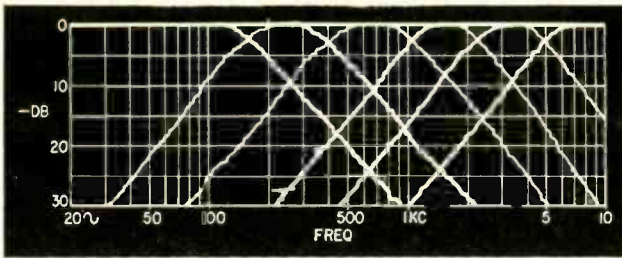

Fig. 4—Response of crossover unit for the various settings of the selector switches. Input was adjusted to give equal 1-volt outputs (0 db) on all three channels.

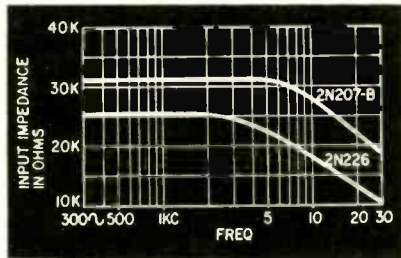

Fig. 5—Crossover input impedance vs frequency for two different transistors.

If only one crossover point is incorrect, other capacitors should be tried for this position—the original ones probably were not close enough to the correct value. The crossover points may be changed by using different value capacitors than the ones shown, as long as the 10-to-1 ratio between C1 and C2 (Fig. 1-b) is maintained (C6 and C8 in Fig. 2, for example).

Connect the input of the crossover to the *cathode-follower* output of a preamp. This is necessary to keep the crossover from loading the preamp. The input impedance of the crossover is dependent on the beta and the cutoff frequency of the transistor used in the emitter-follower first stage. Fig. 5 shows the input impedance vs frequency of the circuit for two types of transistors. Note that even with the worst condition shown, the crossover would not excessively load a cathode follower with an output impedance of 500 to 600 ohms. Most preamp cathode-follower outputs are in this range. The output impedance of the electronic crossover

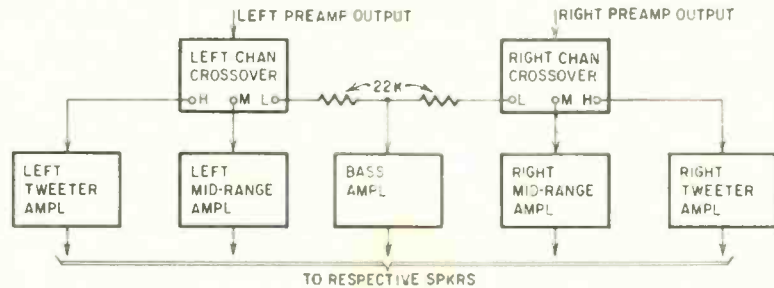

Fig. 6—Stereo system using a single bass speaker.

is low enough to permit cable runs of up to 100 feet to the power amplifiers if necessary.

#### Using the electronic crossover

Connect the electronic-crossover outputs to the power amplifier inputs. Adjust the speakers for equal output levels by varying the sensitivity controls on the inputs of each amplifier. If your amplifiers do not have such controls, add them either to the amplifiers or to the electronic crossover. Use a 500,000-ohm potentiometer connected as a volume control. The controls should be balanced at the loudest level desired

from the system.

Stereo systems could be set up with two electronic three-way crossovers and only one woofer. The Low outputs from the two electronic crossovers could be mixed and fed to the same amplifier and speaker. The mixing is easily done with a resistor network as in Fig. 6. This would make it possible to use two small mid-range speakers and tweeters on each side of the woofer to create the stereo illusion. A 20-watt amplifier in the Low channel and a 10-watt amplifier in both the MID-RANGE and HIGH channels should be more than adequate for the largest rooms. END

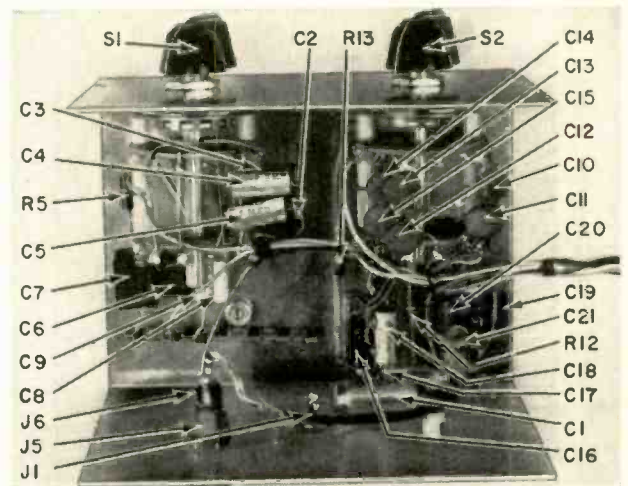
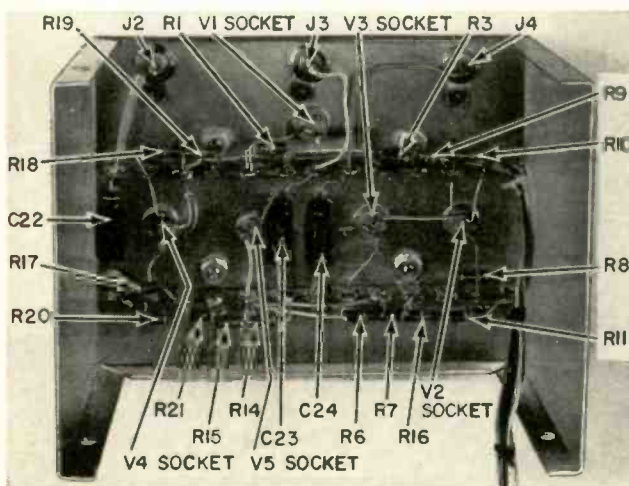

(Left) Parts layout. Cabled wiring goes to other half of case. (Right) Inside bottom half of case.

**COVER  
STORY**

# KITS TEACH ELECTRONICS



Learn electronic fundamentals the do-it-yourself way

By **LARRY STECKLER**  
ASSOCIATE EDITOR

"HOW CAN I PREPARE MY CHILD FOR TODAY'S ELECTRONIC world?" The answer isn't simple. You just don't make a youngster into an electronic genius overnight. He may not even care for the subject. But, thanks to a number of electronic kit manufacturers, you can find out if your child has an interest in, and aptitude for, electronics. If he is interested, these kits indicate and develop that interest.

What are these kits? They're new and different. When one is completed, you don't end up with a high-fidelity amplifier or tuner. You don't end up with a tube tester or signal generator either. Instead, the finished kit teaches a lesson in the form of a simple operating electronic device. And at the same time it tells the builder something about how the device operates.

To see how this is done, let's examine some available kits, see what they offer and how they are made up.

The kit shown on this month's cover is a Heathkit Electronic Workshop model SK-50 (Heath Co., Benton Harbor, Mich.). With it, you can build 19 electronic devices—five transistor radios, code flasher, public-address system, wire-

less voice and code transmitters, electronic timer and many more projects. Special solderless spring-type connectors make setting up the various circuits easy. Flashlight batteries form a safe power source.

Heath offers several other educational electronics kits, each a part of their Electronic Workshop series. Among them are two simpler sets. The simplest one, the SK-30, allows for 6 projects, the next for 11.

Another kit (SK-20) turns out a two-station intercom system. Solderless connections and battery power again make construction safe and simple.

In another educational series, Heath offers three more educational kits. The first, EK-1, is a combination kit and workbook that teaches and demonstrates fundamental principles of electronics. And best of all, when the kit is completed, your "student" ends up with his first piece of electronic test equipment, a basic dc volt-ohm-milliammeter.

The next kit in this series is a two-section job, the EK-2. In the first half, EK-2A, the user is introduced to radio and how it works. A crystal receiver is built as you go



along and improved upon as more topics are covered, until you have a regenerative receiver. The second part, EK-2B, continues the instruction to radio by explaining local oscillators, mixers and other stages of a superhet receiver. The construction section of this kit turns out a two-band superhet receiver that picks up broadcast and short-wave stations.

For the toy market Heath has a Science Explorer Series. It includes a group of three Electronics Experiments Labs that are similar to the Electronic Workshop Series. Also in this group are an intercom kit, a transistor radio broadcast station and three radio kits.

Lafayette Radio's entry into the educational kit field is their KT-173 Twenty-in-One Electronic Experimenters Kit (Lafayette Electronics Manufacturing Corp., 165-08 Liberty Ave., Jamaica 33, N.Y.). With it all kinds of devices can be assembled—a photoelectric relay, electronic game, Citizens-

Inc., 1186 Broadway, Hewlett, N. Y.). With it you can build 20 radio circuits—12 receivers, 3 transmitters, a square-wave generator, amplifier, signal tracer, signal injector and code oscillator. All circuits are built on standard metal chassis, and wiring techniques are the same as those for commercial equipment. All the projects operate on house current.

Eighteen electronic projects can be built with the Electronic Laboratory made by Superex (Superex Electronics Corp., 4 Radford Place, Yonkers, N. Y.). Simplified templates and solderless screw terminals make it possible to build all 18 with only a screwdriver. No soldering is needed and battery operation insures safety against shocks.

General Electric has also entered the educational electronic kit field (G-E, Radio Receiver Dept., Utica, N. Y.). Its contribution is labeled Educational Projects. There are seven kits in the

and all kits include all necessary tools and a detailed instruction manual.

Lionel, known for electric trains, has also entered the scientific kit field (Lionel Corp., 15 E. 26 St., New York 10, N. Y.). Among its selection of Science Project kits is a line of four Electronics Engineering Labs. The Mark I is a basic set that introduces the beginner to electricity through some 25 experiments such as assembling a rheostat, electromagnet and electric bell. Plug-in connections, which are used in all four sets, simplify wiring.

The Mark II is an intermediate set that includes everything the Mark I has to offer, plus instruction and experiments on switching devices. Also it shows how to build and use moisture-sensing devices. The next set in the series, the Mark III, is still more advanced and reaches into the principles of the sensitive relay. It also includes a light-sensing unit and a thermostatic

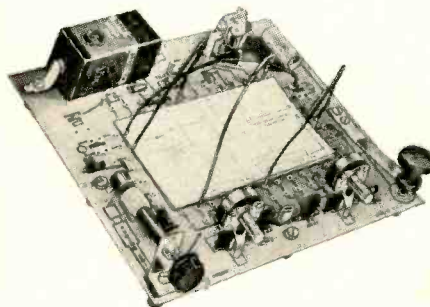

**Knight-Kit 10-Circuit Transistor Lab Kit.**

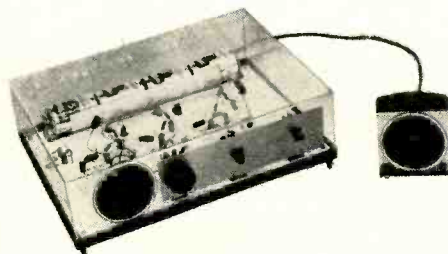

**G-E turns out this battery-powered intercom.**

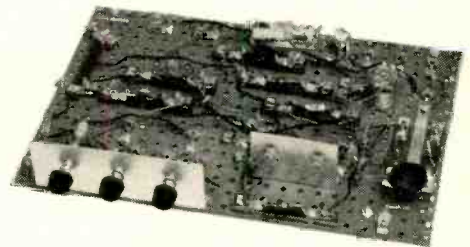

**Lafayette's Twenty-in-One Electronic Experimenters Kit, model KT-173.**

band monitor, wireless mike, transistor tester, and many other similar electronic projects. A road-mapped, perforated board forms the chassis for this kit. Parts are fastened to the chassis with nuts and bolts, and components are wired with Fahenstock clips for easy solderless connections. Like the Heathkits, it is battery-powered for safe operation.

Knight-kit is the first educational kit manufacturer to introduce a printed-circuit board (Allied Radio, 100 N. Western Ave., Chicago 80, Ill.). It is part of their 10-Circuit Transistor Lab Kit. All components are soldered to the printed-circuit board. To set up the various projects, a cardboard circuit diagram is laid down on the board and plug-in wires are used to complete the circuit. Among the 10 projects that can be built with this kit are a two-transistor radio, audio amplifier, wireless broadcaster and voice-operated relay.

Accompanying each project is a complete description of how the particular device works.

Another electronics laboratory is made by Edu-Kit (Progressive Edu-Kits

current series. Each is packaged and sold separately. A basic transistor lab teaches the fundamentals of modern transistor and diode circuits. Ten laboratory projects can be performed with this kit. Among them are a series-tuned radio, transistor detector radio, tuned circuits and an audio amplifier. In these, as in all G-E kits, no soldering is required and all necessary tools are supplied. Components are mounted on a Masonite board, and spring connectors eliminate the need for soldering.

The Basic Electricity Lab allows for 23 experiments including such things as magnetic fields, polarity of magnets, static electricity, magnetic conduction or permeability, the galvanometer, parallel resistance and electrolytic solutions. Next is an advanced Electronics Lab that includes a wide array of experiments (59) designed to teach the basic principles of modern electronic technology.

Also in G-E's bag of tricks are a two-transistor radio and a three-transistor transmitter. An intercom and a basic analog computer round out the line. None of the kits calls for soldering,

control.

The most complex series in the set is the Mark IV. It includes everything offered by the other units plus devices that allow for remote control over lamps, TV sets, electric trains, air conditioners and other electrical appliances. Like most of the other educational kits, all of these are battery-powered for safe operation.

Among the many kits sold by the Science Materials Center are some electronic versions (Science Materials Center Inc., 59 Fourth Ave., New York 3, N. Y.). One is a pre-electricity physics lab that includes 125 experiments on electricity, magnetism and static electricity. A Geiger counter lab supplies all the components for assembling an operating Geiger counter. Safe radioactive samples are included for experiments. All tools are supplied and no soldering is necessary.

Two computer kits round out this firm's offering. One, the Brainiac K-30 Computer Circuits Lab, lets you build 50 different battery-operated logic and reasoning machines. The second is a Calculo Analog Computer Lab that dem-

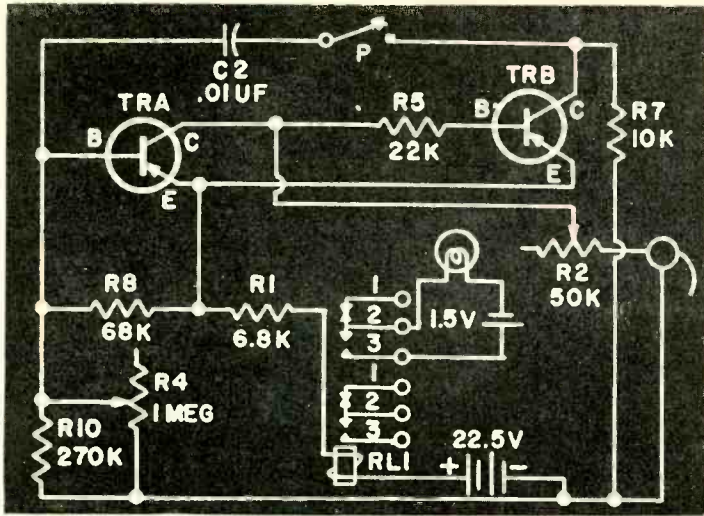

Circuit of the code practice oscillator that can be made with the Lafayette Electronic Experimenters Kit.

# Another Weird one

By H. R. HOLTZ

THE set was a Motorola TS-502; the complaint was vertical roll. The first malfunction detected, B-plus weak. The cure, new seleniums.

Now we could stop the picture, but the vertical circuits were still far from being right. For one thing, the vertical linearity control rolled up the bottom of the picture, rather than extending the upper half, as it should. Also, there was a curious instability about the foldover; it varied in degree, slowly.

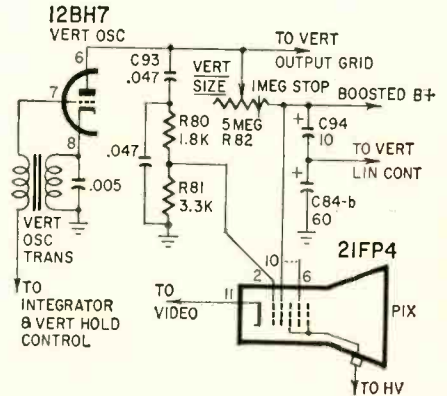

Hum, we decided, an open and shut case.

It looked like a case of waveform. We warmed up the oscilloscope.

Touché! Hum all over the oscillator end of the 12BH7. A hum voltage could be plainly seen, modulating the output (pin 6) of the oscillator. We traced back along the plate circuit to C94. Here we stopped and tried filter substitution. Zounds! Foiled! Hair-pulling, chin-stroking, checking and rechecking. No help, same results.

Obviously, we had one of those odd-balls where anything goes. The junction of C94 and R82 goes to the screen grid, pin 10, of the CRT. We disconnected the CRT by pulling off the socket. The hum disappeared. Obviously a shorted pix tube. We checked the CRT. No evidence of trouble here.

Now we decided to use our eyes (and head) for the first time. Pins 10 and 6 (focusing grid) should be shorted together (see dotted line in the diagram). They were not. Instead, the little shorting link was connecting the control grid, pin 2, to the focusing grid. Normally, at the control grid there is a retrace (vertical) blanking pulse, taken from the junction of R80 and R81 in the plate circuit of the vertical oscillator. This pulse is phase-shifted across the R-C combination. Applied to the focusing grid, it was picked up by the screen and fed back out of phase to provide us with a skull-scratcher.

Of course, the customer had changed his picture tube as instructed in the do-it-yourself manual. END

This meter is the interesting project offered by Heath in their EK-1.

Calculo is an analog computer kit that solves problems in arithmetic, horsepower and kinetic energy.



onstrates how computers use electrical analogies to represent physical and mathematical quantities.

All the kits described have only one purpose—to teach fundamentals of electronics in a pleasant, interesting manner and to give the user an insight into what the electronics field may hold

for him. They also enable parents to find out whether their child is really interested in electronics and whether he has the necessary aptitudes for this ever growing field.

For further information on any of these kits, write directly to the manufacturer. END

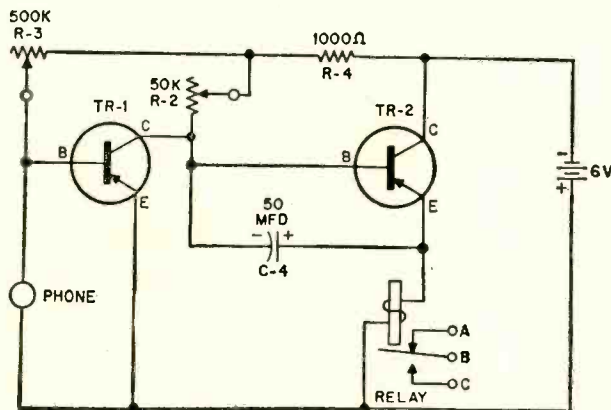

RESISTORS INDICATED IN OHMS  
K=1,000 OHMS

Circuit of the voice-operated relay project in the 10-Circuit Transistor Lab Kit by Allied Knight Kit.

# How relays work

Part I—A close look at clapper, solenoid, induction, thermal, stepping and reed type relays

**T**HE electronic technician who plans to go into industrial electronics should put relays high on his list of must-know subjects. In industry, all control was handled by relays before electronics came along. Even now the majority of industrial control circuits use relays in many forms. With electronic controls, many relays have to be used, and often the technician meets strange-looking devices that don't appear to be relays but are.

Let's see how relays began. In 1824, an Englishman named Sturgeon invented the electromagnet. In 1829, Joseph Henry, professor of mathematics and natural science at Albany Academy, added an armature which carried contacts, and thus the relay was born. In dc circuits, relay design has changed, mostly because of the necessity for mass production and adaptability. But Henry's principle has never been improved upon very much.

In 1886, alternating-current transmission was inaugurated. Where relays were needed, modified dc units served. Then development of special ac relays began, and there were so many contributions in that period that most contributors will probably not get credit for their work. In 1901, Westinghouse introduced the induction relay. These are very common, and are very important in our giant power distribution and transmission systems.

Only in the last few years have new principles been applied to relay service. These principles were made available by materials technology in the elec-

tronics industry. One such development is the Mullenbach Capaswitch, which uses piezoelectric characteristics of artificial materials to obtain mechanical motion. But in contrast to switching by nonmoving devices, such as magnetic amplifiers, vacuum tubes and transistors, relays as discussed here still depend on mechanical motion for their function.

## Classes of relays

Relays can be classified by the method used to translate electrical power into mechanical motion. Thus for dc there are the clapper (the most common)

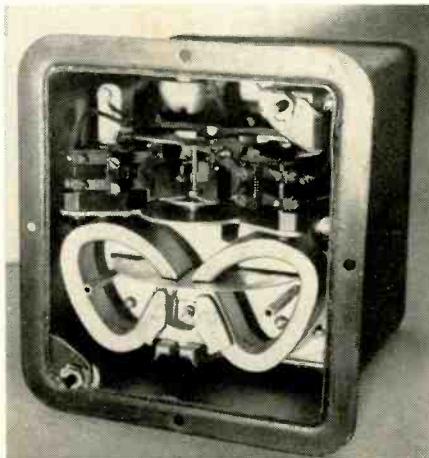

G-E induction relay.

and the solenoid type. Clapper relays are most familiar in the form of telephone relays, small control relays used in model control and similar applications. Fig. 1 shows the basic construction of a clapper relay. Another clapper relay, not as common, is the horseshoe type used in pipe-organ construction. This one is reminiscent of the early Henry relays, except for refinements in construction and materials.

The solenoid relay, in which a movable core is used to open or close contacts, is used where we must take advantage of the greater travel and force available in them, and where the linear motion is particularly suitable for control of the relay characteristics. For example, it is very simple to make

a time-delay relay from a solenoid type by adding a dashpot—a cylinder with a piston. The amount of force it requires for motion depends on what the piston moves. Sometimes this is air, which is allowed to leak out through a small hole controlled by a needle valve. With a steady force on the piston it takes time to move it, and a time delay is obtained. Initially, the air in the cylinder can be compressed somewhat, and the time characteristic of an air dashpot is not linear. To make it nearly so, a noncompressible resisting medium such as oil must be used.

Ac relays also appear in the basic clapper and solenoid types, but their magnetic structure must be laminated, as in Figs. 2 and 3. The laminations prevent the creation of a great deal of heat in the iron due to eddy currents. A shading coil prevents armature chattering. It is a single turn of copper around a part of the armature or core. This single turn acts like a shorted secondary on a transformer. The current in it is approximately 90° out of phase from the current in the coil. When the magnetic field of the main coil goes through zero, the shaded portion of the core still has some magnetic field, keeping the armature in place against the spring force trying to remove it.

The next most prevalent ac relay (although not used in communications) is the induction type. Many of them appear in industry where they protect large generators and motors, compare the current in the three lines of a 3-phase system, and determine whether it is flowing in the proper direction. Practically all types of induction relays

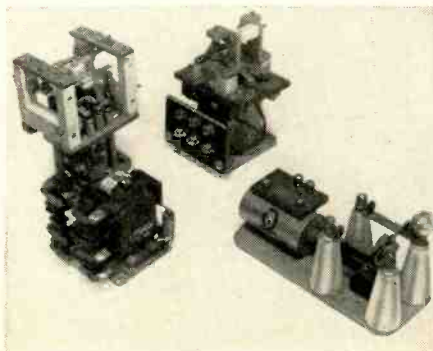

Solenoids are a special class of relays.

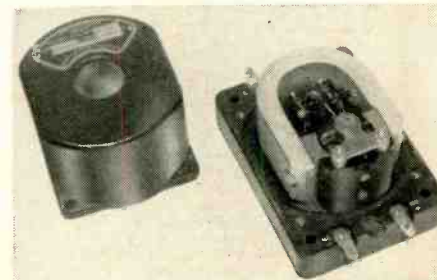

Early Weston meter relay.

# What's New



**FOUR HOURS OF MUSIC** can be placed on the grooved-tape cartridge this device plays. Made in Germany, the player is sold by Westrex, Alpine. It is available as separate unit or in combination with a multi-band radio receiver (AM-FM-SW).

**JAMPROOF RADAR** is run through final tests at Raytheon proving grounds. The 10-ton system and its 40-foot antenna were designed to baffle enemy attempts at jamming and give early warning of possible air attack.

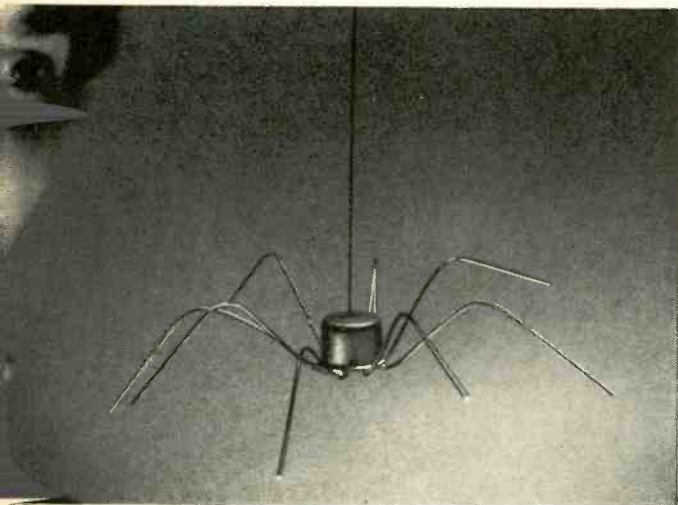
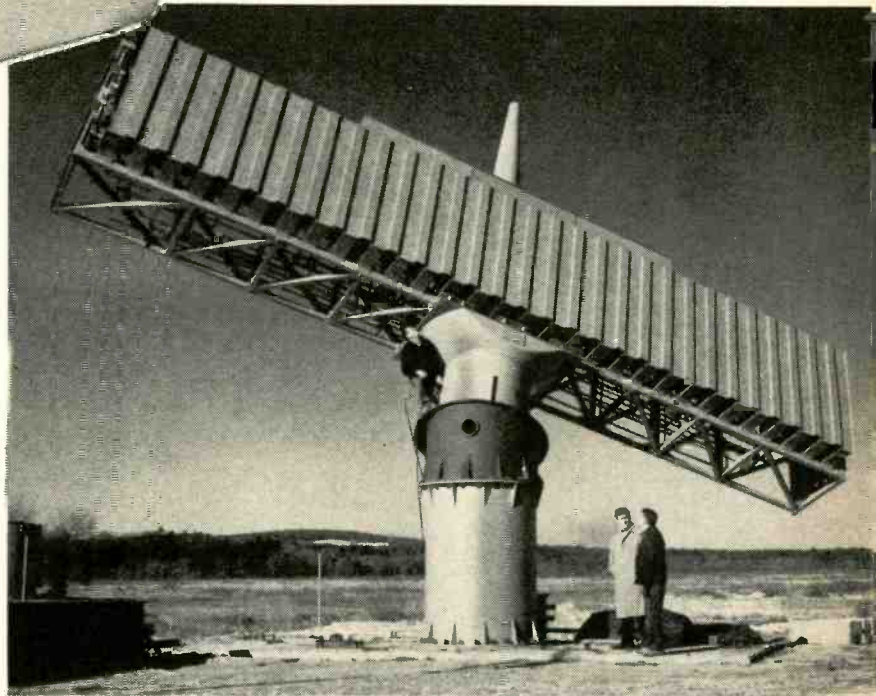

**ELECTRONIC SPIDER** may frighten little Miss Muffet but will be highly sought after by computer engineers. The little device is a logic circuit, containing three diodes, a coupling network, a transistor and two resistors, that fits into a transistor case. It is made by Raytheon.

**THERMOELEMENT PRODUCTION LINE** where final assembly and tests are performed on several thousand Westinghouse thermoelectric elements which will line the walls of an experimental 5,000-watt power plant being built for the Navy.



A LAW-ENFORCEMENT OFFICER—AN agent of the FBI, Treasury Department or border patrol or a member of a local police department—learns the proper use of his firearm as a defense weapon simultaneously with learning how to wear it. Little time is spent studying how to wear it, but a great deal of time, effort, concentration and ammunition go into learning how to use it. Electronics helps the officer while he is learning.

One of the ways electronics helps is by measuring how fast the officer reacts to danger. Precision electronic timers have been developed to guide and train law-enforcement officers and are in use throughout the country. Many are used by more than 250,000 amateur "fast-draw" artists in the US. There is a national association of fast-draw clubs. Each year 10,000 spectators attend a national fast-draw competition at which the fastest "amateur" gun-slinger becomes the national fast-draw champion. There are many competitions among law-enforcement officers too.

By **LEON A. WORTMAN**

## Quick-draw fans, measure your speed to the nearest 1/100 second with this electronic timer

Speed is also important when hunting with a rifle. If you are out for game, big or small, you've got to be able to see, identify, raise and cock the rifle, aim and fire with split-second accuracy. A rabbit moves at about 25 miles an hour, for example. He appears suddenly under your feet, darts across your field of view and disappears in a flash. Takes a good man, even with a shotgun, to bring him to a halt. This holds for larger game too. Few of the millions who hunt see a deer during the season. Fewer get within shooting range. And still fewer can react fast and accurately enough to take the game. Takes lots of practice.

### A timing device

But how can you practice? How can you prove that you are becoming faster? If you want an accurate figure of

speed, a quantitative measure of your merit with a handgun or rifle, make electronics your "shooting mate." Here is an electronically operated timing device very much like those used by law-enforcement agencies. It can measure your speed of reaction and the time it takes to get the shot off, within 1/100 second. It can also measure your ability to sustain rapid fire up to five rounds. That is, from a given signal, how long it takes you to fire five shots.

Two interconnected units are used. One, shown mounted on a tripod, contains the go light, the stop light, and the acoustic pickup. The other contains all controls, electronic components and the precision clock. Both fit into a single small overnight traveling case for easy transportability to and from the shooting ranges. The circuitry (Fig. 1) may be divided into five basic sections: acoustic pickup and amplifier, relay control, switching, clock, and power supplies.

The acoustic pickup is a small speaker mounted behind a cutout in the 4 x 4 x 2-inch box attached to the table-top tripod. The tripod was purchased at a photo-supply store. The speaker acts as a dynamic microphone. Its voice coil connects through a long cable to the control unit in the carrying case. An intercom transformer, T1, couples the voice coil



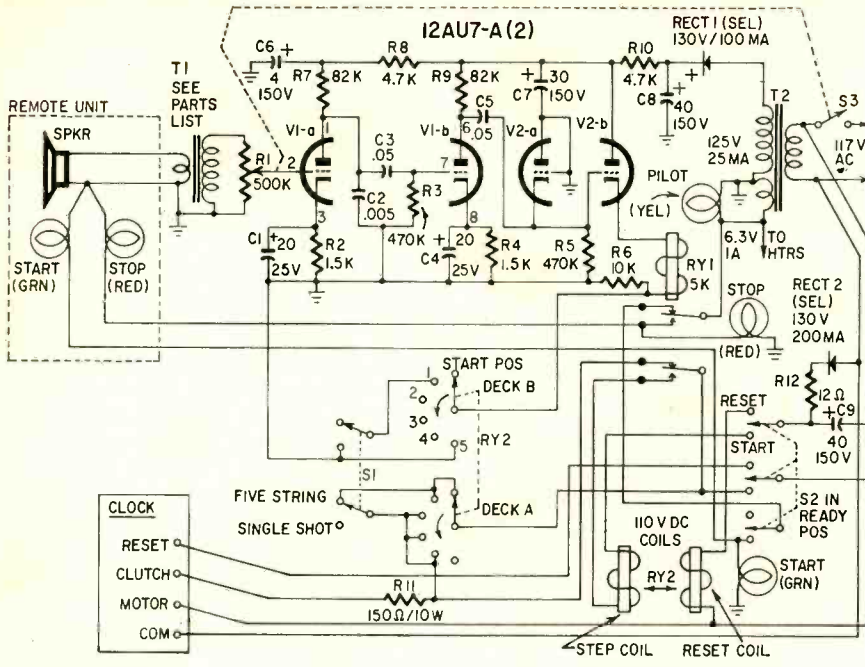

Fig. 1—Circuit of the complete timer.

- R1—pot, 500,000 ohms, with spst switch S3
- R2, 4—1,500 ohms
- R3, 5—470,000 ohms
- R6—10,000 ohms
- R7, 9—32,000 ohms
- R8, 10—4,700 ohms
- R11—150 ohms, 10 watts
- R12—12 ohms
- All resistors 1/2-watt 10% unless noted
- C1, 4, 7, 8—20–20–30–40  $\mu$ f, 25–25–150–150 volts, electrolytic
- C2—.005  $\mu$ f, molded tubular
- C3, 5—.05  $\mu$ f, molded tubular
- C6—4  $\mu$ f, 150 volts, electrolytic
- C9—40  $\mu$ f, 150 volts, electrolytic
- RECT 1—100 ma, 130 volts, selenium
- RECT 2—200 ma, 130 volts, selenium
- RY1—dpdt sensitive relay, 5,000-ohm coil
- RY2—stepping relay (minor switch), 2 poles, 6 positions (minimum) 110 volts dc coils (Relay Sales, Inc., Box 186, West Chicago, Ill. Model R-6175 \$14.85. Or Universal Relay R644 \$13.50 or equivalent)
- S1—dpdt rotary
- S2—3 pdt normally open, lever switch, spring return
- S3—spst on R1
- T1—voice-coil-to-grid transformer
- T2—power transformer: primary, 117 volts; secondary, 125 volts, 25 ma; 6.3 volts, 1 amp
- V1, 2—12AU7-A
- Clock—precision time clock calibrated to 1/100 second (model S-1, Standard Electric Time Co., 89 Logan St., Springfield, Mass.) (\$72 with 117-volt ac clutch. \$78 with 24-volt dc clutch. Electric reset adds \$22 to cost) (Universal Relay Corp., 42 White Street, New York 13, N. Y. sells a similar straight 24-volt unit for \$39.50. They have only a limited number on hand. Ask for MST 360.)
- Pilot-light assembly with No. 47 lamp and yellow jewel
- Pilot-light assemblies with No. 47 lamp and red jewel (2)
- Pilot-light assembly with No. 47 lamp and green jewel (2)
- Chassis to suit
- Miscellaneous hardware

to the grid of one section of a dual triode (V1-a) which is R-C-coupled to the second section (V1-b). This amplifies the low-voltage output of the acoustic pickup.

The relay control section is actuated by V1's output. Because of the relatively high values of cathode resistors used to self-bias V2-b, the static plate current of V2-b is so low that sensitive relay RY1 is not energized. One triode section of V2 is diode-connected to rectify V1's signal output. Thus any output from V1-b is applied as a dc voltage to the grid of V2-b. The method of connecting V2-a across V2-b's grid decreases the bias and increases the plate current to energize RY1. When S2 is depressed, RY1 actuates stepping relay RY2, which in turn locks the action and stops the clock at either the single-shot or the five-string interval (selected by switch S1).

Clocks such as the one used here are manufactured by several companies. They have a mechanical reset, or at extra cost an electrical reset. The clock shown was obtained from a surplus electronics supplier. It is a 117-volt ac unit with a 24-volt dc clutch. However, because of the intermittent and short-run application the clutch can be used on 117 volts ac by inserting a 150-ohm 10-

watt resistor (R11) in series with the power line. This clutch-brake mechanism in the clock, electrically actuated, provides instant start without time drag, and instant stop without time coasting. Thus, time intervals in the order of 1/100 second can be measured precisely.

The stepping relay (RY2) has two coils, one for stepping, the other for electrical reset. It requires 117 volts dc for its operation. This is delivered by one of the two power supplies in the circuit. The components are RECT2, R12 and C9. The other supply powers the tubes.

Circuits can be greatly simplified by eliminating the five-string timing feature. Most practice requirements for either hand guns or shoulder guns, for either fast-draw or snap-shooting as in hunting, are satisfied by the single-shot function. Fig. 2 shows how to wire the clock control, relay and switching circuits for single-shot only.

#### How it works

Let's look at Fig. 2, the simplified diagram for single-shot operation. The triode section of V2-b is biased for low idling cathode current by the high series resistance of RY1's coil and R6. This current is not large enough to energize RY1, and its contacts stay in their normally closed position. The clock motor is running at all times, but its hands are set in motion only when the clutch is actuated. Depressing lever switch S2 completes the start signal circuit (lights the START indicator lamp) and applies power to the clutch to start the clock hands.

Now the shooter draws his weapon and fires. The sharp sound of the gunshot is picked up by a loudspeaker. It is

amplified and fed to V2-b's grid, increasing current through V2-b. This increase energizes RY1 and three things happen simultaneously: power is removed from the clutch to stop the clock's hands instantly; R6 is shorted out to lock the contacts of RY1 in their normally opened position, and the START light is extinguished. To reset the circuit, raise lever switch S2 for an instant.

In Fig. 1, S1 lets the operator time either a single shot or a string of five shots. Five shots are the standard string used all over the world in official handgun competitions. In Fig. 1, S1 is shown in the five-string setting. V2-b is self-biased as previously described and operates in exactly the same way. One set of RY1's contacts actuate the START and STOP signals. The other set of contacts actuates the step coil of RY2, and the clock clutch. RY1 is no longer self-locking. Deck B of RY2 does that job.

Note, that with S1 in the five-string position, R6 is not short-circuited until RY2 has been stepped five times. With S1 in the single-shot position, R6 is short-circuited after RY2 has been stepped once. Each time a shot is fired, RY1 energizes momentarily. Note that Deck A is wired in parallel with the clutch-actuating contacts of RY1. If this were not done, the motion of the clock hands would be interrupted each time RY1 energized and would cause serious inaccuracies in timing. The reset actions of S2 are the same as before with the additional function of applying power to the reset coil of RY2.

#### Using the timer

To use the equipment, place the tripod-mounted box on the ground about 10 feet forward of the shooting position. The control box can be placed at any

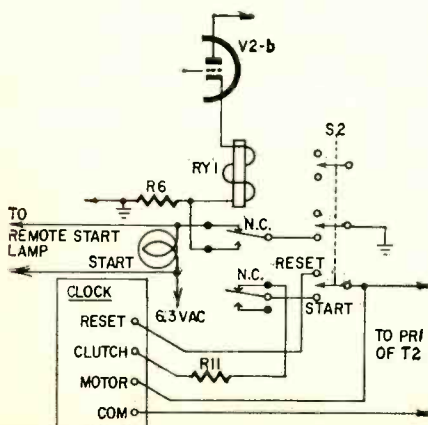
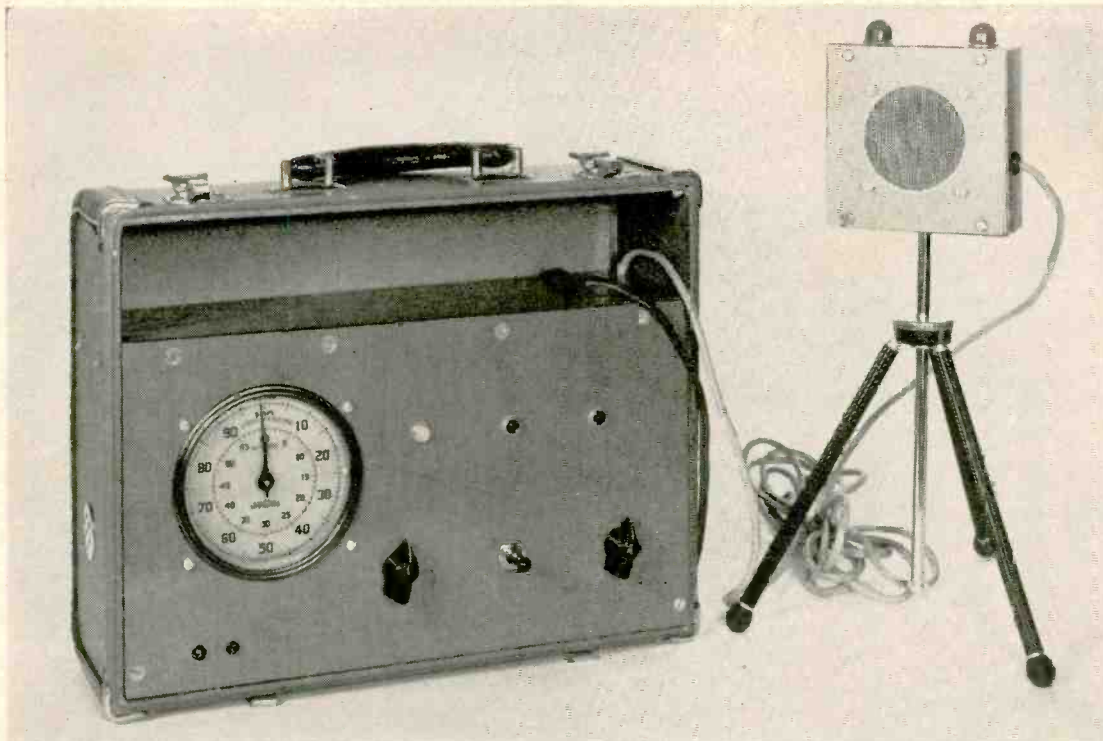

Fig. 2—Simplified circuit for single-shot-only operation. RY2, S1 and stop lights are eliminated. Green light goes on for start and off for stop.



The complete two-piece setup.

convenient position behind the shooter. Plug the power cord into a 117-volt ac power source and make sure the lever switch is in its neutral position. Next, set the sensitivity control. This setting depends on the ammunition being fired but is not critical. It is quickly found by experiment. As a general guide, use a setting approximately one-third of full on with a cap pistol fired indoors. In the open field with a .30-.30 rifle or .38-special revolver the setting can be at approximately one-half. A .22 long-rifle cartridge actuates the mechanism reliably from 10 yards with the setting at two-thirds full on.

Now, select the single-shot or five-string timing action with the rotary switch. With the lever switch at neutral, neither the green START nor the red STOP light is illuminated. The operator selects the starting time, usually without a ready warning to the shooter. He does so by depressing and holding the lever switch down. The clock starts and the green lights go on in front of the shooter and the operator. The shooter goes into action and, on completion of either the single-shot or five-string firings, the clock automatically stops, the green lights go out and the red lights go on. The total time from start to finish is read directly from the face of the clock. The relays and the clock are automatically reset by moving the lever switch to the up position for an instant. The entire unit is then ready for the next timing sequence.

Extraordinary precaution is urged in using the timer. If you use live ammunition, recognize the potential dangers involved to others and to yourself. Shoot into a safe backstop. If you swing your gun as though following running game, make certain the entire backstop is safe and that no one can possibly come into the line of fire.

END

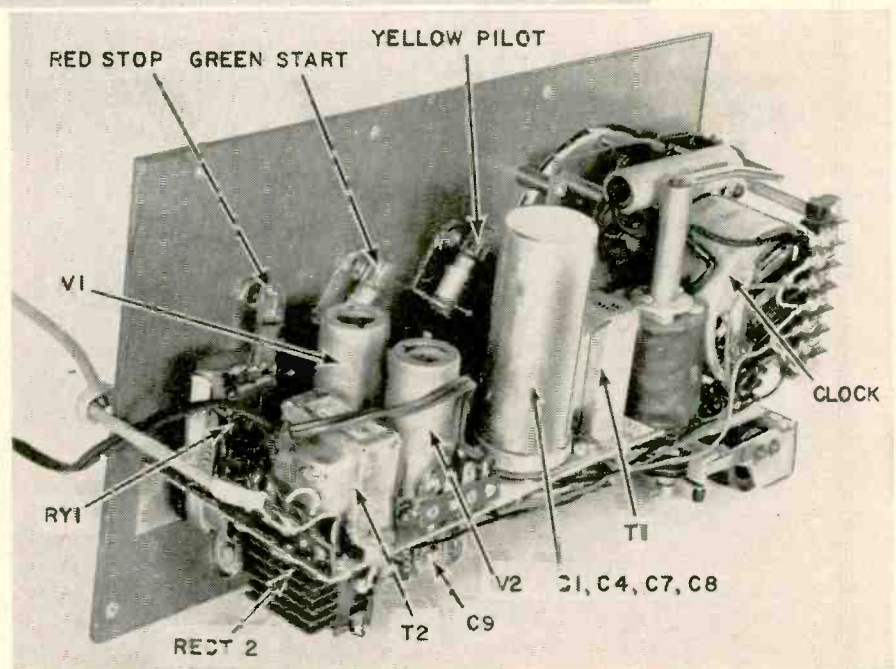

The top of the main chassis.

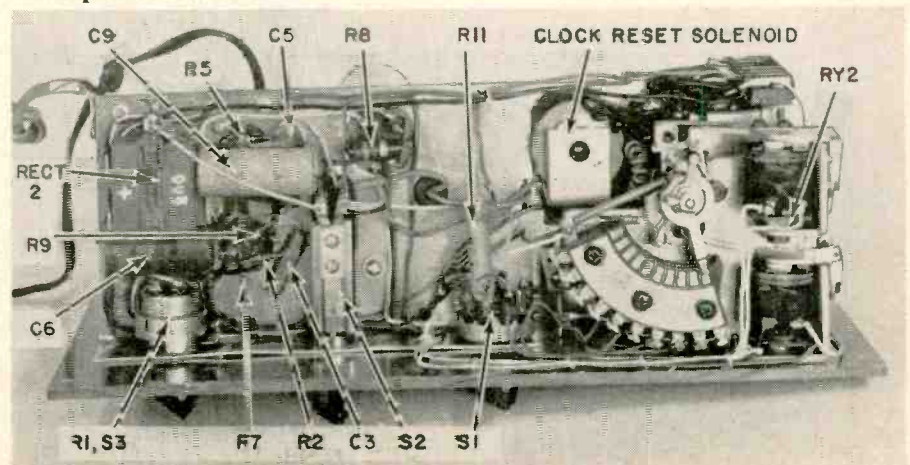

Careful parts arrangement avoids excessive crowding under the chassis.

# INS and

# OUTS

## of WIRELESS INTERCOMS

These simple radio transceivers are easy to service

By ROBERT S. FISHER\*

**T**HOUSANDS of wireless intercoms are in use, and they all require servicing from time to time. They are simple radio transceivers operating on the carrier-current principle. Since they transmit and receive over the power lines, we can set up party-line type intercom systems that don't need interconnecting wires. All the user does is plug the intercom into an electrical outlet. In most cases all the wireless intercom units of a system are in the same building. However, they are working out satisfactorily in some systems where the units are in different buildings and are as far as 2 miles apart. Limiting factors such as meters, line transformers and underground lines can keep the range down as they stop the rf signal.

A wireless intercom operates sequentially. To transmit, you press a switch lever and talk. You release the switch to listen. Unlike the typical wired intercom, there is no master unit. All units are the same. Eavesdropping is not possible—the mike is dead until the transmit switch is closed.

For continuous monitoring, some units have a transmit-receive switch that can be locked in the transmit position.

Wireless intercom systems may be operated without a radio-station license provided they conform with Part 15 of FCC Rules and Regulations. Part 15 stipulates that, at a distance of 1,000 feet, electromagnetic radiation from the transmitter or power lines shall not exceed a field strength of  $2,400/f$  microvolts per meter when operating between 10 and 490 kc (f is stated in kc). When operating between 510 kc and 1600 kc, the same field-strength limit applies, but at a distance of only 100 feet. This means radiation through space, not the strength of the signal transmitted over the power lines.

The Bennett model 101 wireless intercom, a typical piece of this type of equipment, operates on 175 kc. It consists of a 2-watt AM transmitter, and a receiver which employs a modified grid-leak detector followed by a two-stage audio amplifier. The audio amplifier doubles as the modulator when transmitting.

### Receiver circuit

A simplified circuit of the receiver is shown in Fig. 1. The signal from the ac line is fed to a tap on L1 through C1, which isolates the line. The other side of the ac line feeds the bottom of L1 through L2, which is the transmitting-coil output link.

The grid leak does not return to ground, but instead is returned to V1's plate. This biases the grid slightly positive, making the detector more sensitive to weak signals. R1, across grid and plate, also provides degenerative feedback which reduces distortion.

The set's audio output remains fairly constant because of detector avc action. On very small signals, the detector acts like a grid-leak detector in which grid and cathode function as a diode shunted across the signal, and the grid and plate function as an audio amplifier. On strong signals, the detector acts like a combination grid-leak detector

and plate or power detector. In a grid-leak detector, which is very sensitive on weak signals, the plate current is decreased by negative excursions of the applied rf voltage. In a plate detector, negative excursions have little or no effect since the tube is already cut off or almost so, and the plate current is increased by the positive excursions.

When the detector functions as both a grid-leak detector and a plate detector, the positive and negative excursions of a strong input signal each cause opposing effects on plate current at the same time. Of course, these effects are not equal or the signal would cancel. But, they oppose each other enough to limit the amplitude of the resulting audio input signal. Hence, avc action is obtained.

As shown in Fig. 1, the audio signal is passed through an rf filter, consisting of R2 and C6, and is fed to audio amplifier V2 through the volume control R4.

Squelch action is provided by a unique circuit. When no signal is being received, line noise is not heard because the audio amplifier is disabled. It is biased to cutoff by R6 and R7, which make the cathode highly positive with respect to the grid. Hence, the grid is negative with respect to the cathode.

When a signal is received, it is fed through C4 to shunt rectifier D, from

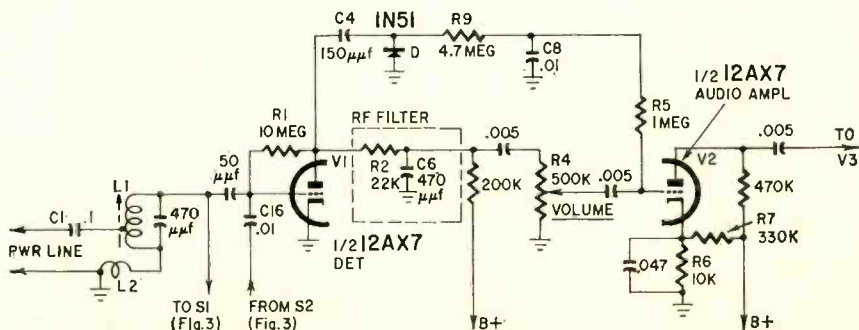

Fig. 1—Basic receiver circuit.

\*President, Bennett Laboratories, Inc.



a point just ahead of the rf filter, producing a dc voltage across D. This positive voltage is fed through R9 and R5 to V2's grid. When it is high enough to offset the bias on V2, the audio amplifier is turned on and the received signal is heard through the loudspeaker. C8 filters out the audio component in the voltage from D and provides sufficient time delay to prevent the audio amplifier from being unquenched by noise pulses.

### Transmitter

In the transmitter, a single beam-power tube functions as both a modulator and a self-excited oscillator. As shown in Fig. 2, the screen grid of the beam tube is used as the oscillator control grid. The screen and plate are used in a series-fed Hartley oscillator. The audio modulating signal from V2 is fed to the control grid which amplitude-modulates the rf signal generated by the oscillator.

The intercom is switched from re-

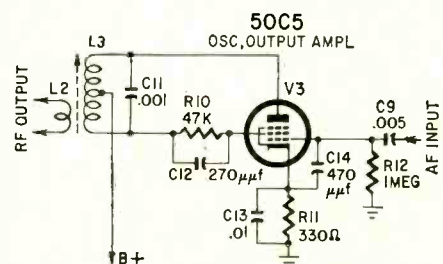

Fig. 2—Simplified transmitter circuit. It is shown integrated in fig. 3 below.

ceive to transmit with a three-position, four-section wafer switch. The center position is for listening, the other two for sending. One transmitting position has a spring return, the other is a locked position.

A simplified diagram of the transmit-receive circuitry is shown in Fig. 3. The four sections of the wafer switch are shown as simple three-position switches, S1, S2, S3 and S4, all set to receive.

In the receive position, the bottom end of the volume control is grounded but in transmit position the ground is lifted by S1 so the volume control is ineffective.

S2 connects R7 to B-plus to bias V2 so it will be cut off when the audio amplifier is squelched. In the transmit

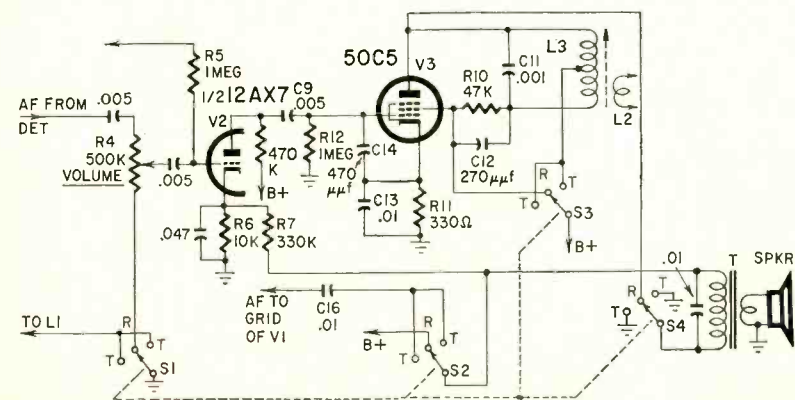
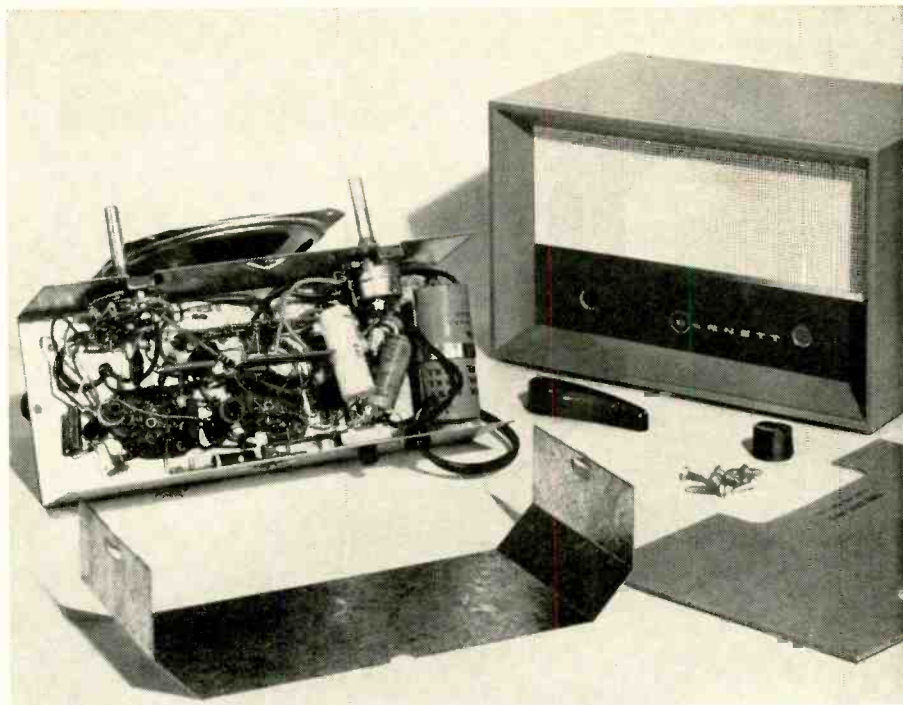

Fig. 3—Transmit-receive switching looks like this.



Interior view of typical wireless intercom.

Bennett Laboratories

position S2 connects one end of the secondary of the output transformer T (now acting as a microphone transformer) to V1's grid through C16. V1 then acts as a microphone preamplifier.

When S3 and S4 are set to the receive position, V3's screen is connected to B-plus and its plate to one end of the output transformer primary. In the transmit position, the same end of the output transformer primary is grounded and B-plus is fed to the tap on L3. The screen is no longer at full B-plus potential.

Therefore, when set to transmit, the switch sections simultaneously ground receiver coil L1 to disable the detector action, make the volume control and squelch ineffective, disconnect the output transformer from V3's plate circuit and connect it to V1's input, and feed B-plus through the transmitter tank coil to V3's plate and screen.

As shown in Fig. 4, the rf input-output circuits are not switched except for grounding the grid end of the receiver coil L1 through S1 when transmitting.

When receiving, the rf signal from

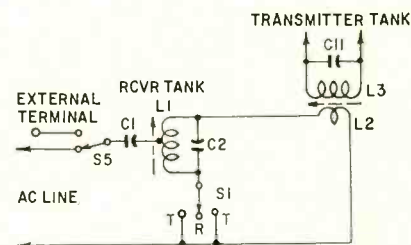

Fig. 4—Details of the rf input-output network.

the ac line is developed across a part of L1, an autotransformer, which steps up the voltage before it is applied to V1's grid. A very small part of the signal is also developed across L2. Because L3 is shunted by the audio power-amplifier circuit components, it is not now resonance at the operating frequency and cannot increase L2's impedance.

When transmitting, the rf signal is coupled from L3 (now resonant at the operating frequency) to L2 and is fed to the ac line through L1 and C1. Since L1 is now detuned because it is grounded by S1, L2 serves as an impedance-matching device.

The circuits shown are not exactly as they are in the equipment, but make it easier to analyze the circuit than when looking at the full schematic, which is printed here for comparison. In the actual equipment, one side of the line is not connected to the chassis, and the grounds shown in the diagrams indicate a common ground bus, not chassis ground.

### Installation and alignment

In most cases a switch on the rear of the chassis (S5 in Fig. 4) is set to the two-wire position as shown in the diagram. The signal is then transmitted and received over the power line. In some locations better results can be

obtained by grounding the "external" terminal at the back of the chassis and setting S5 to the three-wire position. In some cases an improvement may be made by interconnecting the external terminal of all units by a single wire.

Receiver alignment is extremely simple. Merely feed an unmodulated 175-kc signal to the external terminal and set S5 to the three-wire position. Connect the ground lead of the signal generator to the intercom chassis. Connect a dc vtvm across diode D. With the vtvm set to a low-voltage scale (around 0-3 volts), adjust L1's slug for maximum vtvm reading. The signal generator output must be kept very low to avoid AVC action.

Setting the transmitter on frequency is equally easy. Connect a signal generator and an ac vtvm or oscilloscope to the external terminal (switch S5 set to three-wire position) and the chassis. Tune the signal generator to 175 kc and turn up its output control to apply a 1-volt signal to the intercom.

With the intercom set to transmit, adjust L3's slug until zero beat is obtained. This falls between two maximum voltage points you will find when tuning L3. When using a scope, zero beat is the point where the two signals coincide. It is also possible to use a second intercom unit (set to receive) as an audible monitor.

### Field adjustment

Out in the field if no signal generator is available, the receiver can be aligned with the signal from a distant intercom unit while monitoring the voltage across diode D with a vtvm. All transmitters may be set to the same frequency by turning them on in pairs while monitoring with a third unit. One transmitter is tuned until a zero-beat indication is obtained. One of the units of the matched pair is then used as the standard to which other units are tuned.

Experience shows that no unusual service problems are caused by the intercom units themselves. Normal component failures, after extended use, are the same as those encountered with any type of electronic equipment.

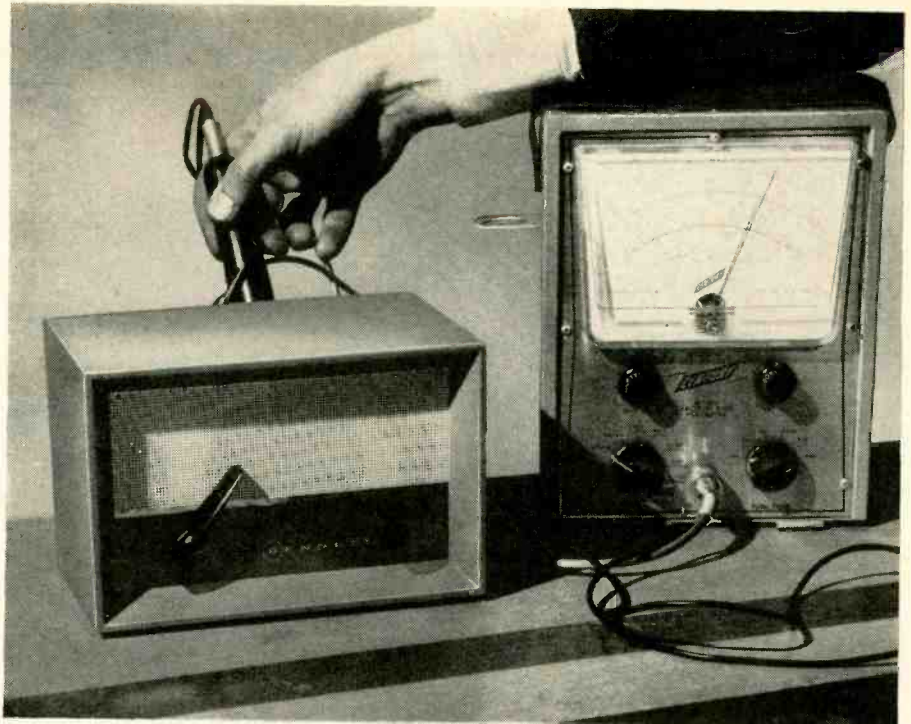

Output is checked with ac vtvm connected to external terminal with talk-listen switch locked in talk position.

Jacques Saphier

Power consumption is only 18 watts so the units may be left on continuously without heat problems as long as they get a reasonable amount of ventilation.

If a customer complains of excessive distortion, it is usually caused by his speaking too loudly, too close to the speaker-microphone. Advise him to talk in a normal voice 2 or more feet away for clean and crisp voice reception.

Except in rare instances, there is no background noise because of the squelch circuit. Even the noise that accompanies a very weak signal is seldom objectionable because of the detector's limiting action, which inherently discriminates against noise pulses.

Noisy reception can often be alleviated by reversing the position of the power plug in the outlet.

Where unwanted radio signals are heard, check the house wiring. In one case we found that a steam pipe touch-

ing a water pipe, but not making a good electrical contact, acted as a rectifier. Various strong radio signals picked up by the pipes were mixed by the rectifier, and many new composite signals were created. The temporary cure was to place a piece of cardboard between the pipes at the point where they crossed. A permanent cure was made by bonding the pipes. A ground clamp was attached to each pipe, and the clamps connected to each other with a braided strap.

The same basic circuits, installation techniques and servicing procedures apply to most modern wireless intercoms. Equipment differs among manufacturers in features and circuit techniques. Including squelch and AVC has eliminated the objections many had to earlier wireless intercoms. When intelligently installed, they do a fine job.

END

Circuit of a complete wireless intercom.

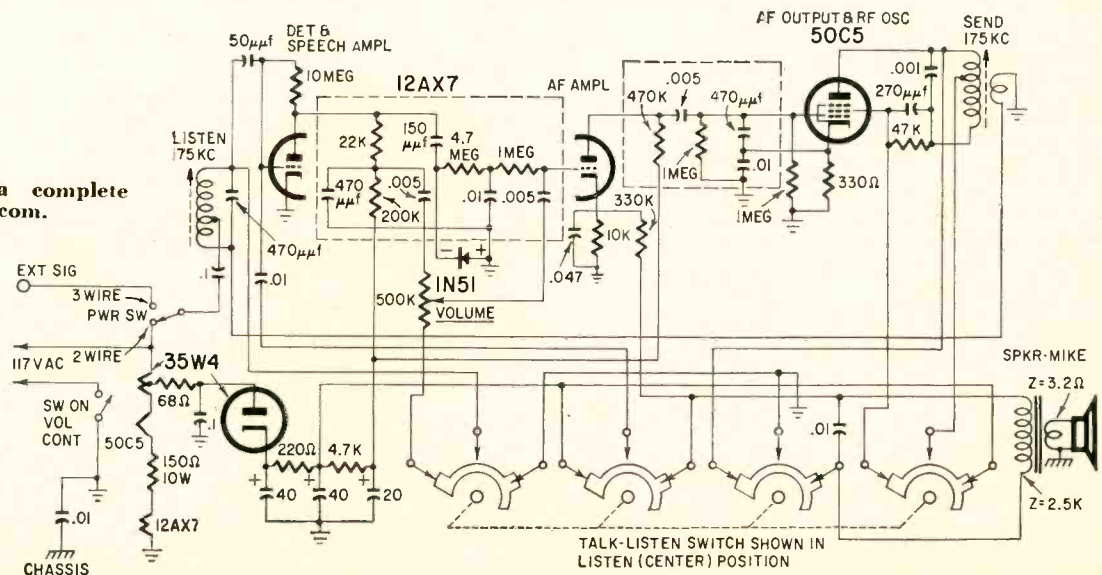

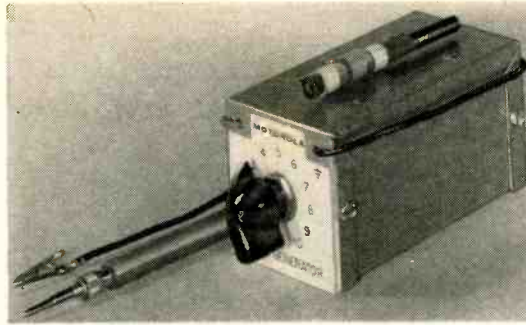

The completed signal generator. Note mounting of coil L on top of unit.

## Service aids for transistor radios

*Two service gadgets cut transistor radio repair time drastically*

By **CARL FINZER\***

**R**ADIO servicing techniques are second nature to today's highly skilled service technicians. They have to be so he can make a profit on the repair of units which cost less, brand-new, than the cost of a single TV or hi-fi repair. In recent years, however, radio has taken on a new look. On the outside, all types of radios are smaller, slimmer, lighter and more portable. On the inside they are often transistorized.

Few technicians have any difficulty in following the schematic diagram of a transistor set. But the troubleshooting and repair of transistor receivers involve some special considerations which have caused many technicians and dealers to turn down such jobs. To reduce some of these problems to a minimum, Motorola has introduced three inexpensive service aids which are available through the company's nation-wide distributor network.

They include a simple signal injector, a unique transistor tester and a universal replacement transistor substitution kit. The two test instruments are designed to make the job of transistor radio servicing as easy and as fast as possible. They are so simple that the average technician with a couple of hours of spare time can build them himself. Described in widely distributed Motorola service publications, they have been thoroughly field-tested by hundreds of technicians.

The substitution kit is intended to eliminate the need for a large, costly and slow-moving stock of replacement transistors ordinarily required to do an efficient job of servicing.

### The signal injector

There is nothing so unresponsive as a dead transistor radio. Tube substitution, which uncovers the majority of troubles in conventional sets, has no

counterpart in transistor servicing, since transistors, unlike tubes, are the least likely suspects in a malfunctioning receiver.

The well practiced techniques of shorting grids or components to produce clicks or some other indication of an operative vacuum-tube stage must be avoided in transistor sets to prevent possible damage to the circuit and transistor. The quickest, surest and most effective way of localizing a defective transistor stage is by signal injection.

Conventional signal generators, of course, are perfectly suitable for this

purpose. More convenient, however, and equally efficient for most purposes, are the simple noise generators which have been gaining increasing favor for rapid troubleshooting. The unit shown here (Fig. 1) is a simple battery-powered multivibrator operating at a fundamental frequency of about 400 cycles. The waveshape is rich in harmonics, covering the if and rf bands, so signals in those regions are readily available in a single palm-sized instrument without any bandswitching.

There are two types of output: a direct output at the test leads, and a radiated signal from the antenna.

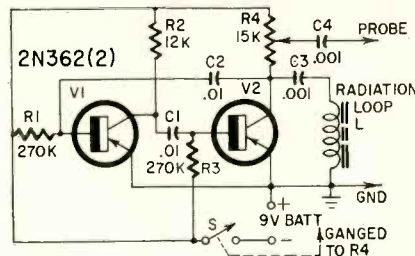

Fig. 1—Two-transistor signal injector for audio and rf circuits without switching.

### PARTS LIST (Fig. 1)

- R1, R3—270,000 ohms, 1/2 watt
  - R2—12,000 ohms, 1/2 watt
  - R4—pot, 15,000 ohms with spst switch S
  - C1, C2—.01  $\mu$ f, ceramic
  - C3, C4—.001  $\mu$ f, ceramic
  - BATT—9 volts
  - L—radiation loop (ferrite core antenna)
  - S—spst on R4
  - V1, V2—2N362
- Test probe  
Alligator clip, miniature  
Chassis box, 4 x 2 1/4 x 2 1/4 inches  
Miscellaneous hardware

### TRANSISTOR KIT CONTENTS AND SPECIFICATIONS

Number	Manufacturer	Application	Type	Construction
2N544	RCA	RF	P-n-p	Diffused Junction
2SA52	TOSHIBA	Converter	P-n-p	Diffused Junction
2N1108	T.I.	Converter	P-n-p	Grown Junction
2N1086	G-E	Converter	N-p-n	Grown Junction
2SA49	TOSHIBA	IF	P-n-p	Diffused Junction
2N1110	T.I.	IF	P-n-p	Grown Junction
2N169	G-E	IF	N-p-n	Grown Junction
2SB54	TOSHIBA	Audio Amplifier/Audio Driver	P-n-p	Diffused Junction
2N1274	T.I.	Audio Driver/Audio Output	P-n-p	Grown Junction
2SB56	TOSHIBA	Audio Driver/Audio Output	P-n-p	Diffused Junction
1N295	SYLVANIA	Diode	—	—

\*Motorola field service specialist.

In signal injection for transistor radios, the direct signal is applied to the transistor bases, starting with the audio driver transistor. In all cases, the generator common or ground lead is connected to the ground or "common" point in the radio. If an output is heard in the radio speaker, proceed to the next transistor base toward the radio antenna. If no output is heard, try the bases of the output transistors. Very little output will result if the generator is applied to the base of one transistor in a push-pull output circuit; so we start signal tracing at the base of the audio driver transistor.

The amplitude of the direct output from the generator is controlled by an attenuator so the operator can determine the relative gain of various stages. The signal fed into the ferrite antenna radiator is not controlled by this attenuator.

The ferrite antenna provides a radiated signal. If this signal is picked up by the radio, but stations are not received, the oscillator is probably dead.

Construction of the signal injector is simple. Because of the low fundamental frequency, parts layout is not at all critical. Only standard construction precautions need be observed.

### The transistor tester

While transistors seldom fail during normal operation of a radio, they can be damaged by other receiver defects. A shorted or leaky coupling capacitor, for example, or a short circuit between closely spaced foils of a printed circuit can result in a bias change which, in turn, could increase base or collector current beyond the maximum for which the transistor is rated. Defective transistors, although sometimes encountered, occur much less frequently than their tube counterparts in radio circuits.

The recommended procedure for servicing transistor radios consists of first localizing the defective stage by the signal-injection method and then

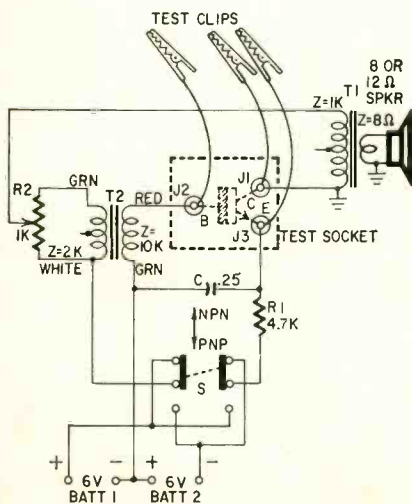

**Fig. 2 — Simple transistor checker.** There is a transistor socket for direct testing and three alligator clip leads that plug into J1, J2, and J3 for testing transistors that won't fit the test socket.

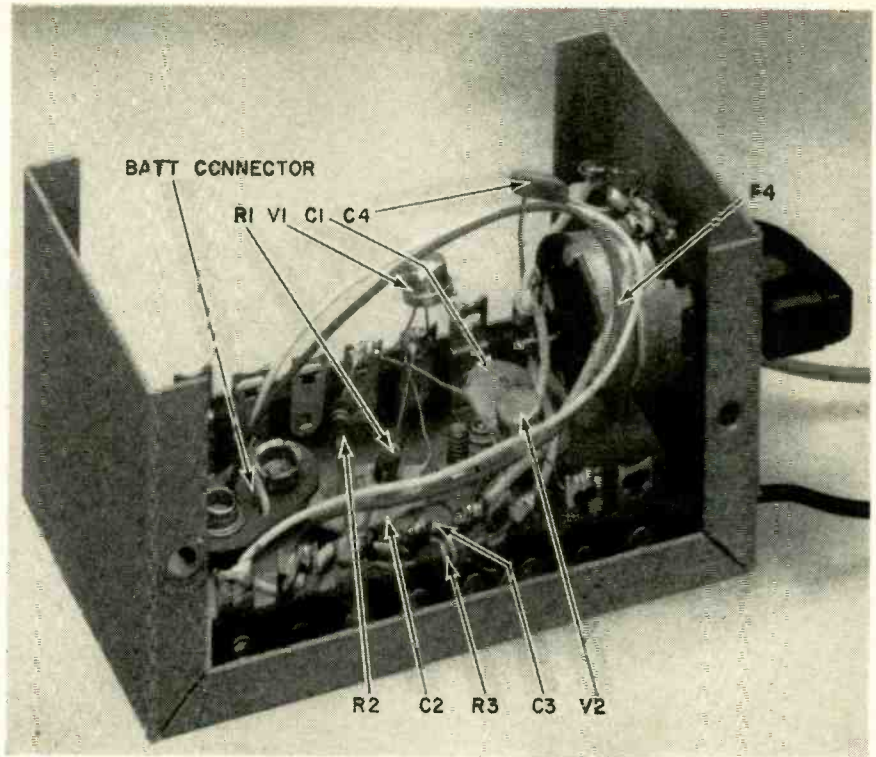

Parts layout inside the signal generator.

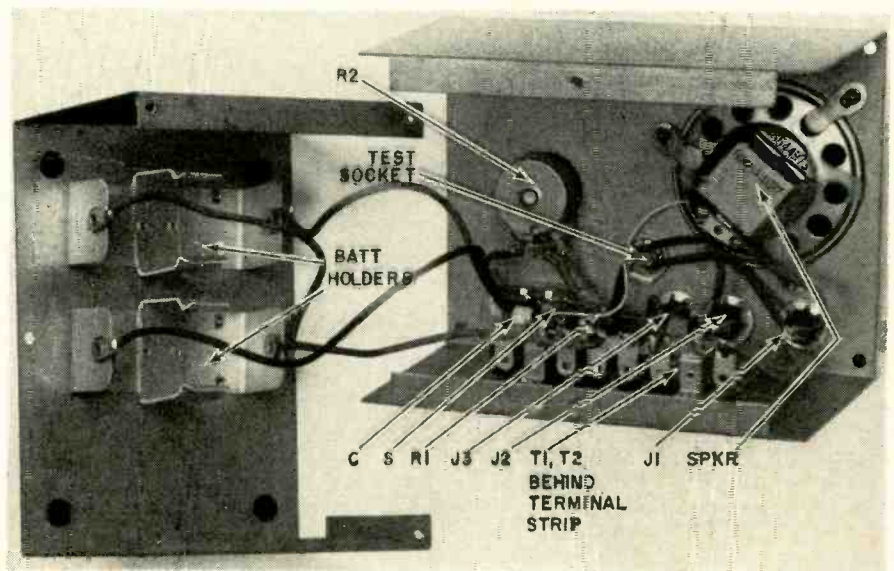

The few components fit easily into the small case.

### PARTS LIST (Fig. 2)

- R1—4,700 ohms, 1/2 watt
- R2—pot, 1,000 ohms, 1/2 watt, linear taper
- C—0.25  $\mu$ f, 100 volts, molded paper
- BATT 1, BATT 2—6 volts (Eveready 724 or equivalent)
- J1, J2, J3—Pin jacks
- S—dpdt slide switch
- T1—audio output transformer, miniature; primary, 1,000 ohms; secondary, 8 ohms
- T2—audio driver transformer, miniature; primary, 2,000 ohms; secondary, 10,000 ohms (Motorola 25K644695 or equivalent)
- Speaker, 2 or 3-inch, 8 or 12/ohms
- Chassis box, 5 x 4 x 3 inches
- Transistor socket
- Alligator clips, miniature (3)
- Miscellaneous hardware

locating the faulty part or parts within the stage. The second part of this procedure is complicated by the low interelectrode resistance of transistors which, shunting the various circuit elements, often makes a resistance check with an ohmmeter entirely inconclusive. An emitter-voltage check will very often localize a defective stage in a radio circuit, but does not necessarily pinpoint the faulty part. Often, normal measuring techniques can be effectively employed only by removing the transistor from the circuit. And, because a circuit defect can damage a

transistor, it is always good practice to check the transistor as well as the other parts of the defective stage. A transistor checker, therefore, is a valuable asset to any service shop. The one shown in Fig. 2 employs no expensive meters or cumbersome roll charts, yet will check *any* transistor rapidly, safely and without ambiguity.

Its circuit is that of an audio oscillator which is completed when a transistor is plugged into the test socket or connected across the clip leads. The unit has only a single control, a feedback adjustment. It can be set to cause any good transistor to oscillate and produce an audible tone through the built-in speaker. Since the power gain of a transistor is directly related to the amount of feedback required to sustain oscillation, the relative gain of various transistors can easily be determined from the setting of this feedback control. Gain is indicated by the point at which the tone ceases as the control is rotated in a clockwise direction. The higher the control setting, the higher the gain. Thus, the tester can be used to:

- ▶ Detect shorted or open transistors.
- ▶ Detect high leakage currents in all transistors.
- ▶ Match transistor gain, as required for push-pull or other critical circuits.
- ▶ Determine whether an unknown transistor is a p-n-p or n-p-n type without danger of damaging the unit.

All this can actually be done in less time than it takes to describe the operation.

To check a transistor, merely set the NPN-PNP switch to the proper position



The finished transistor checker.

(if known), plug the unit into the test socket and rotate the control counter-clockwise. If the transistor type is not known, repeat this procedure with the switch in the opposite position. If the transistor is good, an audio tone will be heard at some setting of the control.

A low-gain transistor, one which oscillates only with a large amount of feedback, is not necessarily defective. To hold transistor yield within economical limits, manufacturers accept a considerably greater range in gain than would be tolerated in vacuum tubes. Usually a low-gain transistor can be compensated for by using a higher-gain unit in some other part of the circuit.

Replacement transistors for push-pull circuits may be matched by simply selecting two replacement transistors with the same relative gain, as indi-

cated by the position of the control at the point where oscillations cease.

Leakage may be checked by first setting the feedback control to the maximum position still producing oscillations. Next, throw the NPN-PNP switch to the opposite position for approximately ten seconds. Returning the switch to the proper position should cause no change in pitch. If there is a change, or if the transistor no longer oscillates at the same control setting, it can be considered defective.

Construction, like that of the signal injector, is completely noncritical because of the low frequency of the oscillator.

### Transistor substitution kit

One of the most vexing problems of transistor radio servicing is caused by the industry's failure, as yet, to standardize transistor types. As a result, literally hundreds of transistors with different numbers appear in portable transistor radios of various manufacturers. Few service shops are inclined to stock even a single unit of each of the many transistor types because it would mean investing a considerable sum of money in a relatively slow-moving inventory. The fact that exactly equivalent replacement transistors are not immediately on hand often causes considerable confusion, not to mention the long delay in returning the repaired unit to an understandably impatient customer.

Cognizant of this problem, Motorola field engineers have investigated the possibility of selecting a small number of transistors which would satisfactorily replace the multitude of units in current use. The resultant kit, consisting of 12 transistors (including two matched pairs) and one diode, provides a satisfactory solution. While we suggest that an exactly equivalent transistor be used to replace a defective one wherever possible, the units in the kit can be employed with excellent results in servicing the vast majority of transistor radios on the market today.

The transistors included in the kit (see the table) were selected on the basis of type (p-n-p or n-p-n), biasing configuration, construction (diffused junction or grown junction) and function (rf, converter, if or audio). The instruction booklet that accompanies the kit points out that an rf or converter transistor of a particular type and construction can usually replace any if and audio transistor of the same type and construction without any ill effects. While the slightly greater cost of high-frequency transistors prohibits production applications in an audio circuit, the fact is that they will work. A consumer couldn't be concerned less over the slight difference in cost when the alternative would be to wait until the exact replacement could be obtained on special order. The kit surmounts the economic problem by supplying a minimum required number of types which will adequately replace units in each circuit at the lowest cost. END

## Transistor handling hints

Avoid bending transistor leads, especially near the base. The wires of some makes of transistors break off near the glass seal very easily.

When trimming leads for a socket fit, use tin cutting shears rather than wire cutters; this results in an even cut without burrs or sharp edges.

Avoid soldering leads into a circuit as much as possible; but, if you must, hold the leads with long-nosed pliers between the iron and the transistor to conduct the heat away.

Use some form of insulation such as spaghetti sleeving or appropriate tape on the base connection of the socket.

Before soldering connections to a socket, insert a discarded transistor. It will set the spring tension contacts in place and at the same time help carry away some of the heat.

Always handle flat shaped transistors

by their ends. This insures against smudging or obliterating the identifying numbers, which may come in mighty handy later.

Avoid subjecting a transistor to an overload by first familiarizing yourself with the manufacturer's specifications.

When changing from an n-p-n to a p-n-p type in the same circuit, triple-check for correct polarity of power source and all associated capacitors and meters.

Become familiar with the specific use to which a transistor is to be put. Avoid using it for another purpose unless all load conditions meet the manufacturer's specifications.

In breadboard style of experimenting, avoid loose or dangling wires which might accidentally damage a good transistor.—*Martin H. Patrick*

# ALL ABOUT TAPE RECORDERS

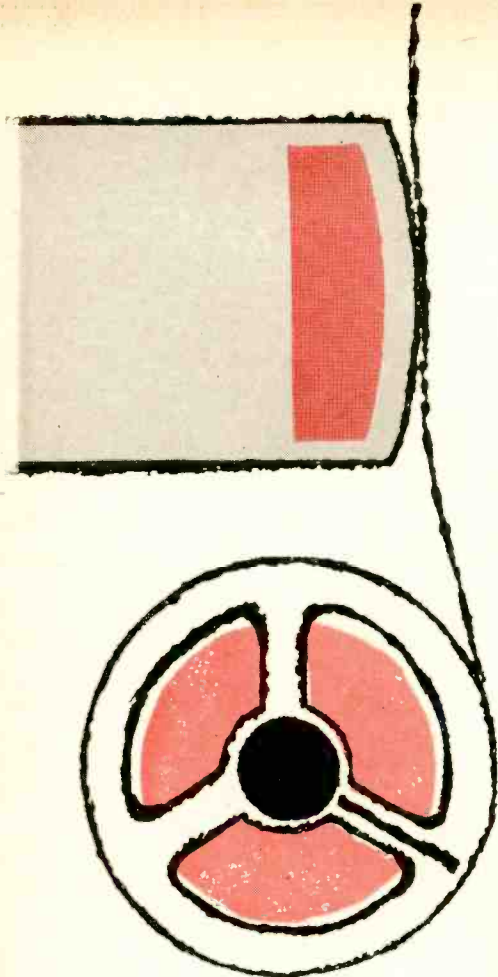

## PART II—LEVEL INDICATORS AND TAPE ERASING

*This section will examine the many types of level indicators used in modern tape recorders. Then we will go on to see how tapes can be erased.*

By **JACK DARR**  
SERVICE EDITOR

EACH MACHINE NEEDS AN INDICATOR TO tell the operator when he is running the amplifier at the correct level for best recordings. It prevents overloading which causes distortion and can cause print-through (the transferral of magnetic fields from one turn of tape to the next) on the reel. This is heard as faint echoes in the playback. Underloading, of course, just produces a weak recording.

There are three major types of indicators: the neon lamp, the electron-ray tuning indicator tube, and, on elaborate home type and all professional machines, a VU meter. (This is not a true VU meter, but usually is driven by an amplifier tube. Hence, when a meter is inoperative, it can be a meter fault or failure of its amplifier tube.)

But no matter what type indicator is used, the purpose is the same—to indicate the amount of audio signal being applied to the recording head.

Neon-lamp indicators are very simple. The lamp is coupled to a source of audio signal with suitable resistors, as in Fig. 1. The amount of resistance determines the amount of audio signal voltage across the combination required to fire the neon lamp. This also depends on the type and size of the lamp itself. For

instance, on the most popular type, the NE-51 or NE-2 (they are similar electronically), let's assume that we want the lamp to fire at a signal voltage of 150. We ought to have about 300,000 ohms in series with it. By altering the value of the series resistance, we can make the lamp fire at any voltage we want, down to its actual firing voltage. Fig. 2 is an actual circuit complete with parts values.

Notice that the two input resistors are variable. In this arrangement we have an extra lamp marked OVERLOAD. It is adjusted to fire only when the applied signal is strong enough to overload the tape.

The actual signal level varies with different machines and with the point from which it is taken off—first audio amplifier, audio output, etc. If the signal is taken from the plate of the first audio amplifier, it is low and additional dc bias must be applied to the lamp to make it fire at the proper level (Fig. 3).

In most commercial circuits, the indicator circuit resistors are fixed. Only the more elaborate machines have provisions for varying this resistance and it is always a factory adjustment. Normally, they should never be reset. If the lamps do not fire as they should or do not fire at all, measure resistances around the circuit, and check the signal voltage applied to them. **Don't change those adjustments except as a last resort!** They will always be screwdriver type pots, mounted underneath the chas-

sis, but can usually be reached from the top or back. In machines using fixed resistors, disconnect and check them very

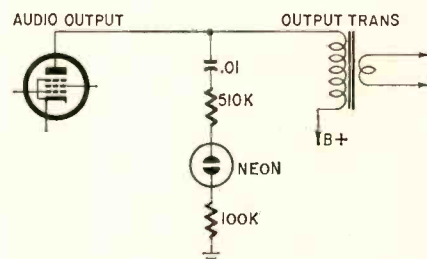

Fig. 1—Basic neon lamp level-indicator circuit.

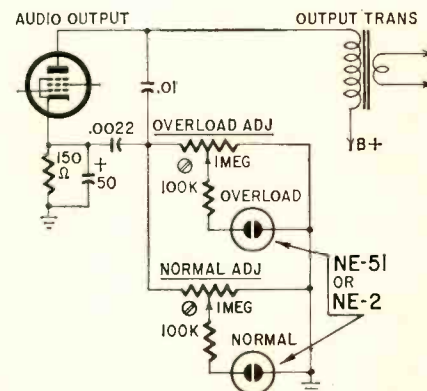

Fig. 2—Two-lamp indicator circuit shows normal and overload operation.

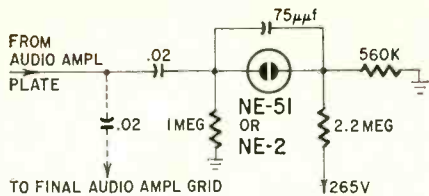

Fig. 3—Dc bias is applied to the neon so a small signal voltage will cause the lamp to fire.

carefully for changes in resistance and drift, especially under heat. Apply the tip of a soldering iron to the resistor and see if it changes in value. Changes in the resistance will upset the operation of the circuit, as will changes in the ionizing voltage of the neon lamps. Therefore, before changing adjustments or checking components, try several other bulbs.

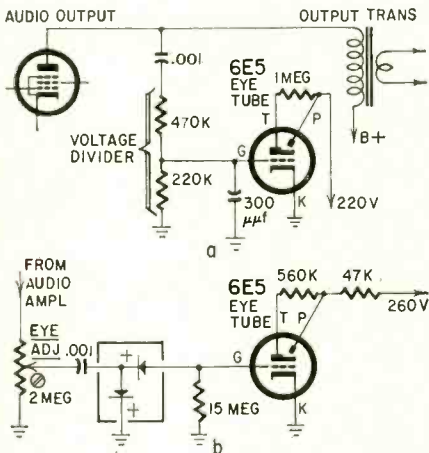

Fig. 4-a—Standard tube-type circuit. b—Variation of same circuit. Voltage is rectified for applying it to the grid.

### Cathode-ray indicators

The tubes used here are very familiar to many old-timers. They were widely used in radios as tuning indicators back in the 1930's. Such types as 6E5, 6U5 are found, with the later EM84's, DM70's, DM71's, etc. They differ from the older ones only in the shape of the fluorescent pattern on the target. The circuit action is the same.

The width of the eye-shaped shadow on the fluorescent screen of the tube varies with changing grid voltages. Therefore, we can connect one of these tubes to a source of signal voltage in the amplifier, and set it up so that the eye just closes when the signal level is correct (Fig. 4-a). Notice the voltage divider formed by the resistors in the grid circuit. By changing the ratio of these resistors, we can make the eye close at any level we want.

A variation of this is seen in Fig. 4-b. Here the designer has placed a small rectifier in the grid circuit. The signal is fed to it through a 2-megohm potentiometer in the grid circuit, marked EYE ADJ. This is another factory adjustment that shouldn't be moved in the field.

If trouble shows up in the eye circuit, first check the signal applied to it, then check the parts in the circuit. In this very-high-resistance circuit, even the

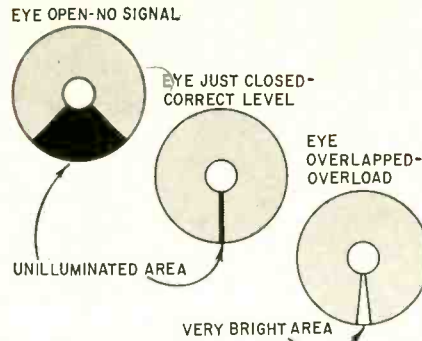

Fig. 5—Typical electron-ray tube indications.

smallest dc leakage in the coupling capacitor will upset the bias on the eye tube. Check that 15-megohm resistor, too! These very large resistors are often overlooked in servicing.

Note the 300-µf capacitor in Fig. 4-a. If open it will allow the bias signal to leak into the eye and cause a continuous indication without audio signal.

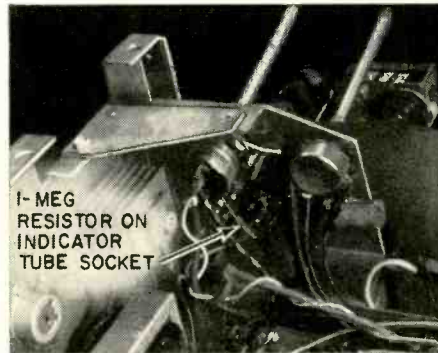

Fig. 6—Bottom view of 6E5 socket on tape recorder. Note position of 1-megohm resistor.

Fig. 5 shows characteristic eye patterns seen under operating conditions. It would be a good idea to measure the peak-to-peak voltage of the signal on the grid or on the EYE-ADJUST control on every recorder that comes in, while they are in good operating condition. Note this value on the schematic; it is seldom given. Then if you have trouble in the future, you'll know what voltage you should find at the various points. In the machines we checked, it ran around 8–10 volts peak to peak for minimum eye closure, and from 40–50 volts during overload (maximum eye closure).

One final hint about eye tubes: If the eye does not move at all, even with a good tube and enough signal, replace the 1-megohm resistor between plate and target. If it has opened or changed in value, the tube will not work. This is usually a very tiny resistor, often mounted on the tube socket, especially if the tube has a socket connected to the

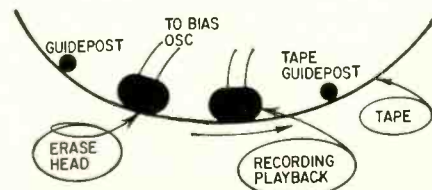

Fig. 7—Tape goes past erase head, then record head.

amplifier by a multi-conductor cable to allow mounting on the upper deck. A typical installation is Fig. 6. The 1-megohm resistor is between pins 2 and 4. (This is a 6E5.)

### Erasing

To make a recording, all material previously recorded on the tape must be removed. The recording is "erased" by passing it through a magnetic field. Early machines used permanent-magnet erasure, but this left noise on the tape. However, some low-cost machines and many miniature transistor units still use dc erase. Later models use ultrasonic bias for erasing. The bias current is fed to a separate erase head mounted so the tape passes over it just before it goes by the recording head (Fig. 7). The ac erase method leaves the magnetic domains of the tape in an almost completely random alignment, ready for whatever new material is to be recorded.

The erase heads are similar to the recording heads. When the tape machine is set to record, the tape is held against the head by a special pressure pad. When permanent-magnet erase is used, the erase head is moved back out of the way during playback. With electronic erase, the power source is disconnected when playing back so there is no chance of accidentally erasing a recording while playing it. Quite a few machines use a "foolproof" method. Some of the numerous contacts on the play-record switch disconnect the plate voltage from the bias oscillator on playback, making it impossible to erase a recording. Most machines have an interlock so that two separate switches must be actuated simultaneously to get into record position.

Fig. 8 shows a closeup of the recording and erase heads on a modern tape recorder. Note the Mumetal shielding over the head. It prevents accidental pickup of stray magnetic fields.

Now and then you'll run into a machine which will not completely erase a previous recording. In most cases this is caused by an overrecorded tape—one that has been recorded at too high a

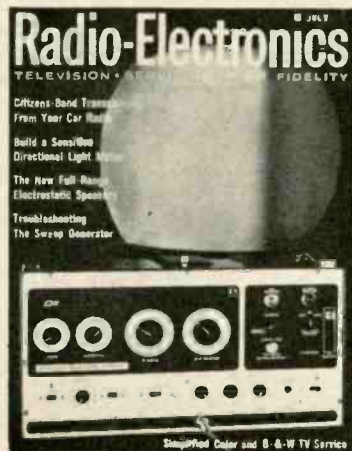

Fig. 8—Two closeups of recording and erase heads.



UNIQUE CIRCUITS IN FM TUNERS  
 BUILD A SENSITIVE DIRECTIONAL LIGHT METER  
 SIMPLIFY SERVICE FOR B-&W AND COLOR TV  
 TROUBLESHOOTING THE SWEEP GENERATOR  
 CB TRANSCEIVER FROM YOUR CAR RADIO  
 THE NEW FULL-RANGE ELECTROSTATIC SPEAKERS

Radio-Electronics  
 July issue on sale June 16



level. To make a valid test, use a brand-new tape, if obtainable, or one which has nothing on it at all. Make a short test recording, being sure that the indicators show that it is being recorded at the proper level. Now play it back, for test, then run it back through the machine.

To erase a recording, set the controls to record, turn the gain all the way down and run the tape through. This should erase all material on the tape, if the erase is working properly. If it does not, check the bias oscillator. Weak tubes, low plate voltage or switching troubles can cause weakness here. Incorrect erase-head alignment, trouble with the pressure pad, or a dirty or badly worn erase head can also cause this symptom. If the machine will not erase at all and there is bias voltage, check the erase head for continuity. The average head can read from 6 to 500 ohms dc resistance, although this is another value seldom found in service data. In general, heads usually fail by opening, not by shorting under load.

#### Bulk erasers

Radio stations and other users of large quantities of tape use bulk erasers to make sure that a tape is completely clean before an important program is recorded. They consist of a large coil with an iron core, in a housing with a handle on it. It is plugged into 117-volt ac. To erase a reel of tape (or several reels, if necessary) the eraser is plugged in and held over the reel, moving it in circles. It is then slowly taken 2 or 3 feet away before disconnecting it. This avoids remagnetizing the tape with the sudden pulse due to collapse of the magnetic field.

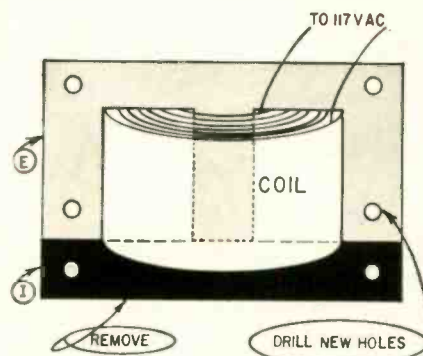

Fig. 9—Home-made bulk eraser for tape. All you need is an old filter choke and a length of line cord.

Incidentally, if you have a filter choke of several henries, such as the ones used in old radio sets, you can make your own bulk eraser easily (Fig. 9). The choke coil must have enough inductance to allow connecting it directly across the ac line without drawing too much current. Take the choke apart and remove all the I laminations, leaving the E's. Replace the bolts, drawing them down tightly. It is used exactly the same as commercial bulk erasers.

Next month we will continue our study of tape recorders with a discussion of record heads and how they work.



# New transistor has gain of 30,000

The amazing composite is the equivalent of a multi-stage cascaded amplifier. Here are some facts about it and some circuits using it

By LOUIS E. GARNER, JR.

**R**OUGHLY analogous to the amplification factor or mu of a vacuum tube, a transistor's beta is its current gain in the common-emitter configuration. By definition, beta is the ratio of the change in collector current corresponding to a given small change in base current at a constant collector voltage.

Sometimes called forward current-transfer ratio ( $h_{fe}$ ), a transistor's beta is directly proportional to the gain that can be obtained when it is used as an amplifier. The higher the beta, the greater the gain the transistor can deliver. For example, if we use a transistor with a beta of 20 as a common-emitter current amplifier, a 50- $\mu$ a change in base current will cause a change in collector current of  $50 \times 20$ , or 1,000  $\mu$ a (1 ma). A similar change in base current in a transistor with a beta of 40 would result in a 2-ma change in collector current.

As a general rule, standard production transistors have betas of less than 100. The popular low-cost experimenter's transistors, for example, have betas between 5 and 30. If we go to premium high-gain units, we find a few types with betas as high as 300, although betas as high as 400 or 500 may be obtained on special order.

There is, as you might expect, an exception to this general rule. One firm, Advanced Research Associates Inc. (PO Box 68, Kensington, Md.), is now producing a line of transistors with betas ranging from—don't faint—10,000 to 30,000. With a beta of, say 20,000, a 50- $\mu$ a current change in the transistor's base circuit can result in a 1-ampere collector-current change. With such high beta values, a single unit can supply as much gain as a multi-stage cascaded amplifier.

## The composite transistor

ARA's high-beta transistors are composite units—essentially multi-element semiconductor devices using a number of p-n junctions. A conventional transistor has two p-n junctions—base-emitter and base-collector. The net effect, then, is to cascade the gain of several devices, much as if individual transistors were connected together in a direct-coupled amplifier (Fig. 1).

Referring to the diagram and, for the moment, ignoring diodes D1 and D2, we see that p-n-p transistors V1, V2 and V3 are direct-coupled through their base-emitter circuits. Thus, V1's emitter current becomes V2's base current, with V2's emitter current, in turn, serving as V3's base current. Since the emitter current of each stage approximates its base current multiplied by the transistor's beta, the overall circuit beta more or less equals the product of individual stage betas. For example, if V1 has a beta of 20, then its emitter current will be 20 times its base current. If we call V1's base current  $I_{in}$ , then V2's base current will become 20  $I_{in}$ . Going a step further, let us assume that V2 has a beta of 30. V2's emitter current will be 30 times its base current, or 600  $I_{in}$ , and this becomes V3's base current.

*AUTHOR'S NOTE: Currently, the ARA composite transistor sells for something over \$40 each in small quantities, making it a relatively expensive component. However, its fantastic gain makes a single composite the equivalent of a multi-stage cascaded amplifier, saving the cost of resistors, capacitors, several transistors, interstage transformers and, in control circuits, sensitive relays. This offsets, to a large degree, its high initial cost and permits the assembly of practical circuits at a total cost roughly approximating that entailed when conventional transistors are used. The manufacturer indicates he is in the process of developing a lower-cost experimenter's version of the composite transistor.*

If V3, in turn, has a beta of 30, its output current will be 30 times its base current, or 18,000  $I_{in}$ —an effective gain or beta of 18,000!

These calculations, of course, are only approximations to show how high gains may be achieved by multi-element devices, for we have failed to take into account the degenerative effect of unby-passed emitter loads and the fact that the output current represents the sum of all three collector currents rather than V3's collector current alone.

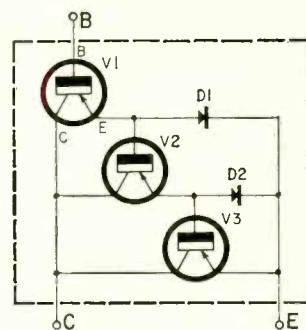

Fig. 1—Equivalent circuit of the composite transistor.

Unfortunately, a three-stage direct-coupled amplifier of the type outlined, while feasible from a theoretical viewpoint, cannot be built for the leakage currents as well as the signal currents are amplified by each stage. If V1 has an emitter-collector leakage of, say 200  $\mu$ a, this will be multiplied by both V2 and V3, even if these transistors have zero leakage of their own. The output leakage current would be  $30 \times 30 \times 200$ , or 180,000  $\mu$ a (180 ma)!

Obviously, an emitter-collector "leakage" on this order would be intolerable in a practical device.

We find another fly in the ointment when we consider temperature effects.

As temperature increases, the resistance of common semiconductor junctions decreases, leading to an increase in leakage currents. In a cascaded amplifier, this effect is multiplied and can lead, in a short time, to thermal runaway.

In the ARA composite transistor, leakage currents are minimized by using a semiconductor element (as V1) with extremely low—virtually “zero”—internal leakage. Temperature effects are minimized and any tendency toward thermal runaway eliminated by connecting semiconductor junctions in parallel with and thermally coupled to the base-emitter junctions of each “stage.” In Fig. 1, diodes D1 and D2 do this and are electrically and thermally matched to their respective “transistors,” V2 and V3.

Referring again to the diagram, D1 shunts part of V1's emitter current around V2's base-emitter circuit. Similarly, D2 is a shunt across V3's base-emitter junction. Any increase in temperature which results in a decrease of the transistors' internal resistance causes a corresponding decrease in diode resistance, thus making the diodes more effective “shunts” and reducing base current to compensate for increases caused by temperature.

Typically, the ARA composite transistor has the input characteristics of a small-signal or low-power transistor. Its input impedance is around 2,000 ohms, and base-bias currents are on the order of a few microamperes. Its output characteristics, on the other hand, are more like those of a conventional power transistor for its collector current is generally between a few hundred milliamperes and several amperes in typical circuits, with its output impedance measured in ohms.

Currently, five basic types are in production. Of these, four are germanium and one is silicon. All have extremely high betas. The basic characteristics of available units are summarized in the table.

Since the composite transistor is a multi-element device, it can be manufactured with special characteristics not found in conventional units. For example, ARA is producing two units analogous to the experimentally developed hook collector transistor in addition to more familiar p-n-p and n-p-n types. These are ARA types 25N-H (2N1019) and 25P-H (2N1020). Using conventional designations, the type 25N-H might be called a p-n-n transistor, for it has the input characteristics of a p-n-p and the output characteristics of an n-p-n unit. The 25P-H, by the same token, is an n-p-p transistor for it has the input characteristics of an n-p-n and the output characteristics of a p-n-p type.

### Basic circuit

The composite transistor's fantastically high gain and unique input and output characteristics permit its use in circuits which are extremely simple when compared to those using conventional transistors. A typical supersensitive relay circuit having a variety of

**Breadboarded experimental circuit using a composite transistor as a light-controlled relay.**

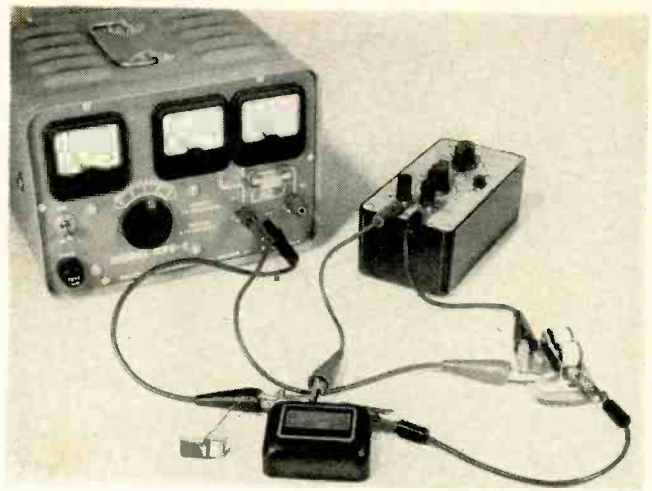

practical applications is shown in Fig. 2. Here, a 2N626 n-p-n composite is used as a common-emitter dc amplifier that actuates a suitable load device when the circuit's input terminals are shorted.

In practice, the power source can be a line-operated power pack supplying 2 or 3 amperes or, if preferred, a 6- or 12-volt battery. A ½-watt resistor may be used for R1, a standard potentiometer for R2 and a conventional toggle or slide switch for S. The load may be any one of a variety of electrical or electromechanical devices, including a lamp bulb, buzzer, bell, dc motor or power solenoid. The sensor connected to the circuit's input terminals may be a snap-action switch, thermistor or thermostat, depending on the job to be done. A variety of 6-volt lamps and buzzers can be used since the arrangement is the same as connecting the lamps or buzzers in series with a 6-volt battery. The only limiting factor is the maximum current that can be handled by the composite transistor. In my circuits, I used automobile bulbs (they draw about ½ ampere) and a standard 6-volt buzzer. Of course, I used a 6-volt battery. With a 12-volt battery, 12-volt lamps and buzzers are used.

For example, this circuit may be used to assemble an automatic control which closes a window and sounds an alarm whenever it starts raining. To do this, simply connect a buzzer and window-closing motor in parallel as the transistor's load. Then connect a moisture-sensitive sensor across the input terminals and adjust R2 so the motor and buzzer operate when a few drops of water fall on the sensor.

A suitable moisture sensor is illus-

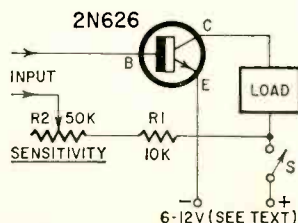

**Fig. 2—Basic circuit of composite transistor in a common-emitter amplifier. Current gains of 10,000 or more are possible.**

trated in one of the photographs. It is made of two metal combs mounted on a small plastic base so the teeth interleave but do not touch. A drop of water bridges adjoining teeth, closing the circuit.

The transistor normally operates without base-bias current and little or no collector current flows through the load. When the input terminals are closed by the sensor, base bias is applied through R1 and R2, permitting collector current to flow and actuating the load devices. In a typical circuit, a base current of as little as 60 μa will result in a collector current flow of over ½ ampere.

### Practical applications

A variety of composite transistor circuit applications are shown in Figs. 3 through 8. In each one, standard, readily available components are specified, with circuit polarities set up for a type 2N626 n-p-n transistor. If preferred, the 2N676 p-n-p type may be used. Simply reverse all dc polarities. The common-emitter configuration is used in all the circuits shown and all have been bench-checked. In practical assemblies, neither layout nor lead dress should be especially critical. If the transistor is used on a continuous basis, mount it on a metal chassis or similar heat sink.

Available from Allied Radio (100 N. Western Ave., Chicago 80, Ill.) as well as direct from the manufacturer, the composite transistor is a relatively expensive component. However, in a practical control or amplifier circuit, the high cost is offset by the circuit simplicity which results from its use and by its superior temperature characteristics. In an amplifier, for example, the composite transistor can deliver a gain comparable to that of a three-stage circuit, and its cost can be compared realistically only to the total cost of assembling such an amplifier.

When used in the assembly of control equipment, composite transistor circuits may even compete with those using conventional transistors. The ability to handle relatively large output currents often eliminates an expensive sensitive relay. Here, the transistor drives the output load directly.

Let's take a look at a few easily duplicated circuits.

### Burglar alarm

The control circuit shown in Fig. 3 may be used in a burglar-alarm installation which will protect a home, office, store or even a small manufacturing plant. If an intruder breaks into the premises, a buzzer sounds and a warning lamp is turned on.

The entire circuit can be assembled on a small metal chassis or inside a

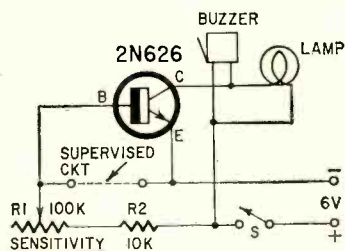

Fig. 3—Burglar alarm using the composite transistor.

standard Minibox. R1 is a small potentiometer, R2 a ½-watt resistor. The buzzer and lamp are 6-volt types, readily available through hardware and electrical supply stores. A lock type spst power switch is used. The power source can be any standard 6-volt dc source, including a battery eliminator, built-up power supply, heavy-duty dry battery or storage battery. The only criteria is that it be able to supply several milliamperes indefinitely and 2 or 3 amperes for short periods. Once assembled and checked, mount the control circuit in a heavy-duty metal wall cabinet which can be locked.

The supervised circuit connected to the control's input terminals encloses the protected premises and is made up of a closed series circuit which includes foil tape on large window areas and closed-circuit contacts on doors, windows, vents and other openings.

In operation, the transistor's base-bias current, supplied through R1 and R2, is shorted by the supervised circuit. A break in this circuit, caused by a broken window or jimmied door, removes the short, restores base bias, increases collector-current flow and operates the buzzer and lamp. In practice, R1 is adjusted so the buzzer and lamp operate with the circuit terminals open.

### Sound relay

To sound-trigger and actuate a lamp, buzzer, solenoid or motor, use the circuit shown in Fig. 4. As before, use any suitable 6-volt power source (a 12-volt source may be desirable with some types of loads). A toggle, slide or rotary power switch may be used. R1 is a ½-watt resistor. Its value is chosen experimentally for optimum performance with the type of load used, but generally will fall between 100,000 and 500,000 ohms. C is a 100- $\mu$ f 12-volt electrolytic capacitor, but its value is not too critical—values from 50 to 200  $\mu$ f will give good results.

A loud sound near the microphone produces an ac signal which, after being rectified by D1 and filtered by C, in-

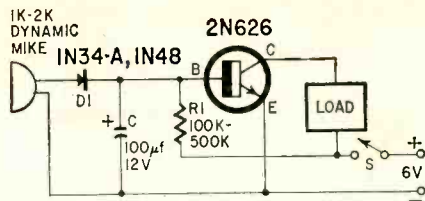

Fig. 4—Sound-actuated relay circuit.

creases the transistor's base-bias current, causing a corresponding increase in collector current which actuates the output load. The steady base bias supplied through R1 also biases the diode, making the device relatively insensitive to lower-level background noise. Overall circuit sensitivity depends on the current required to operate the load device and on the mike's characteristics.

### Light-controlled relay

Sounding a buzzer when a light beam is broken, the circuit in Fig. 5 may be used for a doorway annunciator, an electric-eye burglar alarm or similar light-controlled devices. The photosensitive unit is an International Rectifier type B2M selenium cell. A 6-volt buzzer

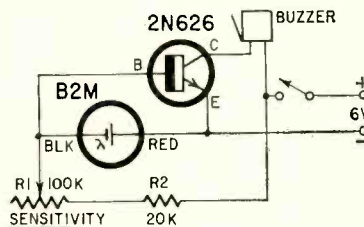

Fig. 5—Light-controlled relay circuit.

or bell serves as a signal device.

When not illuminated, the selenium photocell has a relatively high resistance. This permits the base-bias current furnished through current-limiting resistor R2 and SENSITIVITY control R1 to control collector current. In practice, R1 is adjusted with the photocell dark until the buzzer (or other signal device) is actuated. With a light beam focused on the cell, its dc resistance drops and a small dc voltage is developed which opposes the bias applied through R1 and R2. The net effect is to reduce severely or to cancel the transistor's base bias, causing a large drop in collector current and silencing the signal. Thereafter, any interruption in the light beam will cause the buzzer to sound.

In a practical device, the builder often can use the special characteristics of electromechanical devices for different modes of operation. Most buzzers and bells, for example, require a higher current to initiate than is needed to maintain operation. So careful adjustment of R1 will permit a self-latching action. Once the beam is interrupted, the buzzer continues to sound, even after the light beam is restored. This type of operation is preferred for burglar alarm installations. The system is reset by restoring the light beam and interrupting the power momentarily.

The effective range of the device depends on a number of factors, including ambient light conditions, whether a lens is used ahead of the photocell, and the

intensity and sharpness of focus of the light source. In an experimental circuit, I got good operation at distances of up

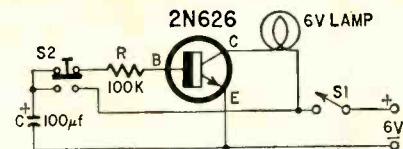

Fig. 6—Composite transistor in a time-delay relay.

to 20 feet using a heavy-duty flashlight as a light source; no lens was provided for the photocell.

### Time-delay relay

An instrument based on the circuit given in Fig. 6 may be used to turn a lamp bulb on for a predetermined period of time after a pushbutton is released. One typical application is as an automatic control for a photographic enlarger. For other applications, the lamp might be replaced by a buzzer, bell, motor or solenoid.

In operation, the transistor normally has no effective base bias and collector current is virtually nil. The lamp remains dark. When S2 is depressed, C is connected directly across the power supply and receives a full charge. Now when S2 is released, C is reconnected to R and serves as a source of base bias as it discharges through R and the transistor's base-emitter circuit. This, in turn, permits a corresponding, but much greater, flow of collector current, lighting the lamp. The lamp stays on for a period determined by the R-C time constant of C, R and the transistor's base-emitter resistance, finally dimming and going dark as C is discharged. Afterward, the entire cycle may be repeated simply by depressing and releasing S2.

Several modifications in the basic circuit are possible. A vernier control over time delay may be added by replacing R with a 100,000-ohm potentiometer and adding a 10,000-ohm series resistor to limit base current. Several ranges may be provided by adding a rotary selector switch and using several capacitors in place of C. Depending on the time-delay ranges needed, capacitor values from 50 to 1,000  $\mu$ f may be used.

### Slave photoflash

An interesting application for the composite transistor is shown in Fig. 7. Here, the transistor fires a remote or slave photographic flashbulb when triggered by light from the main flash. A unit of this type provides additional light when photographing large areas or supplies back and side lighting similar to that used in photoflood photog-

(Continued on page 64)

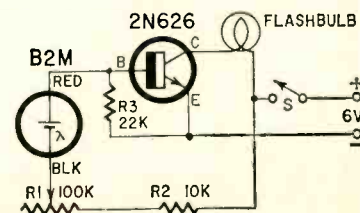

Fig. 7—Slave photoflash circuit.

Only Heath offers  
Top Quality at the  
Lowest Price, and ....



# NOW—we guarantee you

**At your service . . .**

**THE NEW HEATHKIT AUTOMATIC GARAGE DOOR OPENER!**

Compare price, compare features, and you'll buy this latest Heathkit labor-saving wonder! Opens and closes all overhead track-type doors up to 8' high automatically! Garage light turns on when door is open, stays on for short period after door closes! Safety release device. Adjustable operating force! Tone-coded "hi-power" 6 or 12 v transmitter and special receiver prevents interference. Easy one-man assembly. All parts included. 65 lbs.

- Kit GD-20 (mechanism, transmitter, receiver) . . . \$11 dn., \$10 mo. . . . . **\$109.95**
- Kit GDA-20-1 (extra transmitter) . . . \$2.50 dn., \$5 mo. . . . **\$24.95**

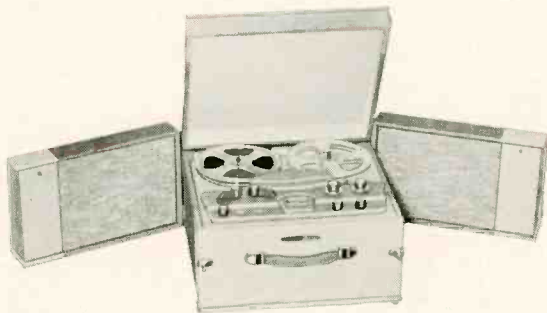

**BIG-BUY PORTABLE 4-TRACK STEREO TAPE RECORDER**

All-in-one monophonic or 4-track stereo tape record and playback! Two tape control levers; individual tone balance and level controls; monitoring switch for listening while recording; "pause" button for editing; two "eyes" to check recording levels. Also functions as "hi-fi stereo center" for record players, etc., or to feed tape music to separate hi-fi system. Parts for all amplifiers and speakers included; turquoise and white cabinet and 3 3/4"–7 1/2" speed tape deck are assembled. Less mic.

- Kit AD-40 . . . 49 lbs. . . \$18 dn., \$16 mo. . . . . **\$179.95**
- Assembled ADW-40 . . . 49 lbs. . . \$30 dn., \$26 mo. . . . . **\$299.95**



**NEW HIGH FIDELITY PA AMP.**

Heath exclusive; 20 watt *hi-fi* rated PA amp. Two inputs; equalization switches; electrical mixing; sealed "pads"; tape recorder, line, and voice coil output. Plug-in, low-Z mic. Xformers separate. 24 lbs.

- Kit AA-31 . . . \$6 dn., \$6 mo. . . . . **\$59.95**
- Mic. Xformers, AN-11 **\$11.95**

**"LEGATO-COMPACT"**

All Altec Lansing speakers! 2-12" hi-compliance woofers; exponential horn and driver; range 30-22,000 cps; assembled. 800 cps network. 30 watts program; 16 ohm Z. Assembled, finished cabinets; 32" x 19" d x 32 3/8" h 132 lbs.

- Kit AS-21U, unfin. **\$224.95**
- Kit AS-21W, wal. **\$229.95**
- Kit AS-21M, mahog **\$229.95**

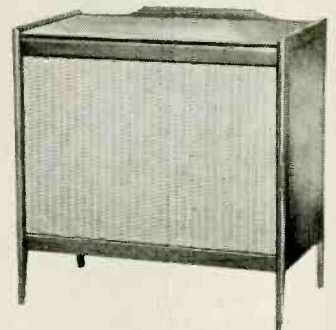

**HEATH COMPANY** Benton Harbor, Michigan



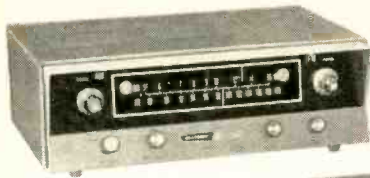

Introducing a new styling concept in two popular Heathkit Stereo Units



Here's a handsome matching pair for your new Heathkit stereo system! Both have new louvered wrap-arounds of luggage-tan vinyl-clad steel with contrasting charcoal-grey front panels framed with polished aluminum bezels . . . a regal new look to Heath's medium-price stereo line.

**HEATHKIT AJ-11 AM/FM TUNER**

Successor to the popular AJ-10, this new version features fly-wheel tuning, two "magic-eye" tuning indicators, adjustable FM automatic frequency control, AM "fidelity" switch for max. selectivity or fidelity, dependable 12 tube circuit, built-in power supply. 21 lbs.

Kit AJ-11... \$7 dn., \$7 mo. .... **\$69.95**  
 Assembled AJW-11... \$13 dn., \$11 mo. .... **\$129.95**

**HEATHKIT AA-151 28-WATT STEREO AMPLIFIER**

Here's the popular SA-2 model all dressed up in brand-new styling. Delivers 28 hi-fi rated watts (14 per channel) for plenty of power. Has clutched volume controls, ganged tone controls, 4 dual inputs. 28 lbs.

Kit AA-151... \$6 dn., \$6 mo. .... **\$59.95**  
 Assembled AAW-151... \$12dn., \$11mo. .... **\$119.95**

*can build any Heathkit!*



**IGNITION ANALYZER**

Switch to primary, secondary, parade or superimposed patterns. See condition of plugs, points, wiring, coil & condenser. Plug-in ID-11 Timing Light available. 15lbs.

Kit IO-20... \$9 dn. .... **\$89.95**  
 Assembled IOW-20... **\$169.95**



**NEW TELEPHONE AMPLIFIER!**

Hands-free phone chats! Ideal for conferences, dictation, etc. Place handset on cradle, unit turns on, instantly ready! All-transistor; long-lasting battery power. Easy to build. Ivory color.

Kit GD-71... 4 lbs. .... **\$19.95**



**LOW COST DEPTH SOUNDER**

Best value in marine electronics. Detects fish, submerged objects, and bottom depth. Big 4 3/4" dial calibrated from 0-100'. 6-transistor circuit, battery powered. Corrosion & splash-resistant aluminum cab. Transducer included. 9 lbs.

Kit MI-10 \$7 dn., \$7 mo. **\$69.95**



**LOW COST 3-BAND MARINE RDF**

Deluxe features at minimum cost. Covers 200-400kc beacons, 550-1600 kc broadcast, 1700-3400 kc marine band. Loop and "sense" antennas eliminate double null. 9-transistor circuit, battery powered. Pre-assembled tuning unit.

Kit DF-3 12 lbs. \$10 dn. **\$99.95**

**You get guaranteed success with Heathkit!**

Never before has a manufacturer of do-it-yourself kits guaranteed your success in completing a project. Heath does so and backs it up with an iron-clad, money-back guarantee! By making this guarantee, we hope to banish any doubt you may have about your ability to build a kit. How is such a guarantee possible? The careful planning that goes into the design of Heathkit equipment revolves around this paramount thought—anyone, regardless of background or experience, must be able to build any Heathkit. This same thought guides the writing of the detailed Heathkit assembly instructions with the world famous "check-by-step" system. These attributes plus the experience of a million customers attests to the fact that anyone can build a Heathkit. Order your favorite Heathkit today. Enjoy top quality equipment with savings of up to 50% and the satisfaction of doing it yourself. Get guaranteed success with Heathkit!

**MONEY BACK GUARANTEE**

The Heath Company *unconditionally guarantees* that you can build any Heathkit product and that it will perform in accordance with our published specifications, by simply following and completing our check-by-step instructions, or your purchase price will be cheerfully refunded.



**FREE Catalog!**

Contains complete descriptions and specifications on all of the above new models plus more than 200 other famous Heathkit items. Send for your free copy, use the coupon below; see how you can enjoy top quality equipment with savings of up to 50% with Heathkit!

Ordering Instructions: Fill out the order blank. Include charges for parcel post according to weights shown. Express orders shipped delivery charges collect. All prices F.O.B. Benton Harbor, Mich. A 20% deposit is required on all C.O.D. orders. Prices subject to change without notice. Dealer and export prices slightly higher.

Please send the following items:

Item	Model No.	Price

Order direct by mail or see your Heathkit dealer.

Ship  Parcel Post  Express  C.O.D.  Best Way



**HEATH COMPANY**  
 Benton Harbor 20, Michigan

PLEASE SEND MY FREE COPY OF THE 1961 HEATHKIT CATALOG

Name \_\_\_\_\_

Address \_\_\_\_\_

City \_\_\_\_\_ Zone \_\_\_\_\_ State \_\_\_\_\_

(Continued from page 61)

SPECIFICATIONS OF COMPOSITE TRANSISTORS

TYPE NUMBER	TYPE	V <sub>CE</sub>	I <sub>CE</sub>	P <sub>CAV</sub>	f <sub>ae</sub>	CURRENT GAIN, h <sub>fe</sub>	MATERIAL
2N626 (ARA-25-N)	NPN	30	3 A	10W	4 KC	18,000 TO 30,000	GERMANIUM
2N676 (ARA-25-P)	PNP	-30	3 A	10W	4 KC	15,000	GERMANIUM
2N1019 (ARA-25N-H)	PNN	30	3 A	10W	4 KC	15,000	GERMANIUM
2N1020 (ARA-25P-H)	NPP	-30	3 A	10W	4 KC	15,000	GERMANIUM
2N1161 (ARA-46P)	PNP	-40	3 A	40W		10,000	SILICON

raphy, while retaining the advantages of flash techniques.

The power supply is made up of four standard flashlight cells in series to supply 6 volts. In a practical assembly, a suitable reflector must be placed behind the flashbulb and a lens and hood used to concentrate light on the photocell while minimizing the effects of background light. Also, the flashbulb-reflector assembly and photocell lens should be independently adjustable, so the photocell can be aimed at the triggering light source and the flash pointed toward the subject.

In operation, base bias is established by a voltage divider made up of R1, R2, the resistance of the photocell, and base resistor R3. With the photocell dark, it has a high resistance and a low bias current is supplied, thus keeping the transistor's collector current below the value needed to fire the flashbulb which serves as a collector load. A sudden increase in the light on the photocell (when the main flash is fired)

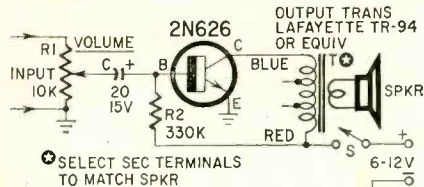

Fig. 8—One-stage audio amplifier can replace an entire audio system.

causes a corresponding drop in its internal resistance and the generation of a small voltage which aids the bias applied through R1 and R2. The net result is a sudden increase in base-bias current, a corresponding increase in collector current and a fired flashbulb. R1 is variable so circuit sensitivity can be varied for different field conditions.

General-purpose amplifier

The circuit of an audio amplifier using a single composite transistor is given in Fig. 8. Featuring moderately high gain and a power output ranging upward from several hundred milliwatts, it may be used for assembling a test amplifier for the lab, as a phonograph amplifier, as the complete audio section of a receiver or in similar applications. The limited high-frequency response of

the composite transistor prohibits the circuit's use in hi-fi applications, however.

A 6- to 12-volt power supply can be used. The 12-volt supply gives somewhat greater power output. C's voltage rating should be higher than the voltage delivered by the power supply. A universal 10-watt output transformer couples the circuit to a PM loudspeaker. I used a Lafayette type TR-94.

In operation, base bias for class-A operation is supplied through base resistor R2. A portion of the audio signal applied to VOLUME control R1, depending on the control's setting, is applied through dc blocking capacitor C to the transistor's base-emitter circuit. The amplified signal developed across the transistor's collector load, the transformer's primary winding, is coupled by the transformer to the speaker. In some cases, the output transformer may be omitted, and the speaker's voice coil used as the transistor's collector load. This arrangement saves a transformer, but limits the circuit's power output, for a steady dc flows through the coil.

Other applications

The circuit applications described were chosen with an eye toward their appeal to the experimenter and hobbyist. At the military-industrial level, the composite transistor is used in many other applications, some of which are classified for security reasons. In general, however, this unique transistor is used in control devices, regulated power supplies and servo systems. In a servo amplifier, for example, the composite transistor permits a great simplification of circuitry since the transistor can be

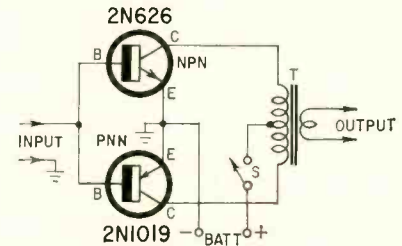

Fig. 9—Push-pull amplifier using conventional and hook type composite transistors to eliminate the need for a phase inverter.

used to furnish direct drive to many types of servo motors while, at the same time, providing an overall gain equal to that of multi-stage circuits.

One interesting application is illustrated in Fig. 9. Here, n-p-n and p-n-p composites are used in a class-B push-pull amplifier. While retaining the advantages of balanced push-pull operation in the output circuit, permitting the use of a conventional center-tapped output transformer, the circuit requires a single-ended input signal, eliminating the need for a phase inverter or center-tapped input transformer. Thus, the circuit combines the efficiency of class-B operation with the high gain of a multi-stage amplifier, while requiring but a single input signal. While the same job could be accomplished with conventional transistors, the resulting circuit would be quite complex.

Late word from the manufacturer shows he is developing a lower-priced "experimenter's" version of the composite transistor. It will sell for less than half the price of currently available units, but will retain most of the desirable characteristics, except for a lower maximum voltage rating. END



Type 2N626, a germanium n-p-n composite transistor.

Easily assembled moisture sensor. Used with the basic circuit of Fig. 2, this unit forms part of a sensitive moisture or rain alarm.

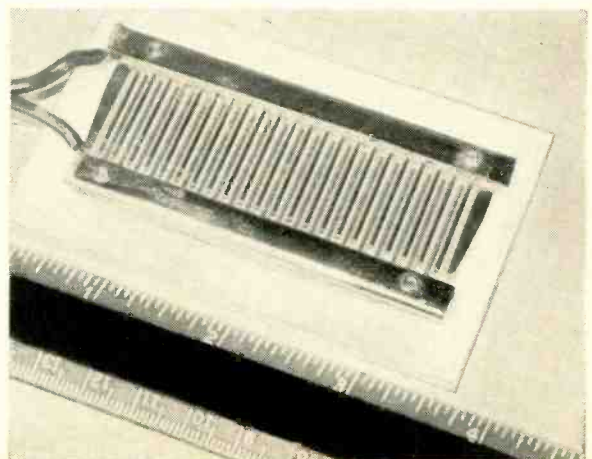

**PICTURE OF A  
SERVICE-DEALER  
MAKING A  
\$6.90 PROFIT  
IN 6 MINUTES**

**WITH A  
JFD EXACT REPLACEMENT  
TV ANTENNA INSTALLATION  
FOR GE DESIGNER PORTABLE**



**The Place:** Almost any service shop

**The Time:** Any time between 8 A. M. to 6 P. M.

**The Product:** JFD EXACT REPLACEMENT NO. TA362 (GE dipole) *one of 62 JFD O.E.M. antennas for portable TV sets now available from your local JFD distributor.*

**The  
Facts: JFD TA362**

Your actual selling price (no phony lists) . . . . .	\$9.75
Dealer cost at 40% off . . . . .	5.85
Profit on sale . . . . .	3.90
Installation charge . . . . .	3.00
<b>TOTAL PROFIT . . . . .</b>	<b>\$6.90</b>

You earn a double profit: a full mark-up profit on the antenna sale—and a profit on the installation. Your customer gets the antenna that's built precisely for his set—you get rid of low-profit "rabbit ears" and the cut-throat competition that goes with them.

**The Aids:** Complete listings in SAMS Photofact folders...plus exclusive Exact Replacement Antenna Guide for portable and toteable TV's (printed by the Howard W. Sams & Co., Inc.) provide you with finger-tip reference data. See your JFD distributor for your aids or write direct to JFD.

**The Moral:** *Get your JFD PA500 and PA515 Exact Replacement Kits today from your JFD distributor and start earning yourself a fair share of the 3,500,000 dollar-portable antenna replacement market. Remember, next to receiving tubes, the antennas of portable and "tote-able" sets require the most frequent replacement.*

**MAIL THIS COUPON FOR YOUR JFD EXACT REPLACEMENT PROFIT PORTFOLIO!**

THE BRAND THAT PUTS YOU IN COMMAND OF THE MARKET

**JFD**

**JFD ELECTRONICS CORPORATION**

6101 Sixteenth Avenue, Brooklyn 4, New York  
JFD International, 15 Moore Street, New York, New York  
JFD Canada, Ltd., 51 McCormack Street, Toronto, Ont., Canada

JFD ELECTRONICS CORPORATION

6101F Sixteenth Avenue, Brooklyn 4, N. Y.

Gentlemen:

- I want to participate in the JFD Exact Replacement Profit Plan. Send me full details.
- Also send me the name of my local JFD distributor.
- Send FREE JFD 1961 Exact Replacement Wall Chart.

..... The name of my local JFD distributor is:

NAME \_\_\_\_\_

ADDRESS \_\_\_\_\_

CITY \_\_\_\_\_ ZONE \_\_\_\_\_ STATE \_\_\_\_\_



The front panel of the B&K model 600.



The Mighty Mite can be removed from its carrying case and installed in a panel, on a counter or in a tube caddy.

# 2 MINIATURE TUBE CHECKERS

New, smaller tube checkers combine the convenience of the multiple-socket tester with small size for easy handling. Tests are made for shorts, gas and cathode emission, and what the manufacturers feel is the best approach to these is revealed in a look at two representative types.

By WAYNE LEMONS

Our first impression of the Sencore model TC109 Mighty Mite was that it was a "mite" too small to be much more than a gadget. We were in for a pleasant surprise. In the "gas" or grid leakage test it excelled more expensive checkers. This test spots those slightly leaky tubes that so often cause age and sync troubles.

The TC109 makes the grid-leakage test by tying all tube elements except the grid to a positive 45-volt source. The grid is then connected to a built-in 6C4 vtvm circuit. Any leakage from the grid to any element(s) of the tube being tested results in a meter reading. To prevent damaging the meter, a 10-megohm resistor is wired in series with the 6C4 grid. Thus high positive voltages tend to be nullified due to grid-current flow in the resistor. The circuit

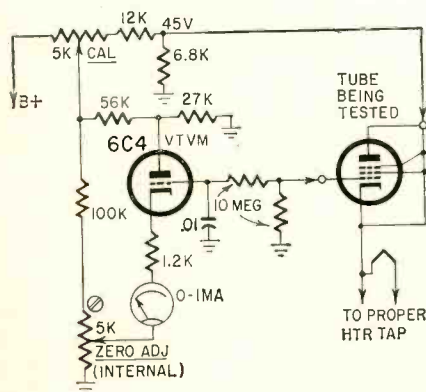

Fig. 1—Grid-leakage test circuit of the Sencore TC109.

action broadens the response of the meter so as little as a 100-megohm leakage (approximately) causes the meter to read 50% of full scale. A dead short produces only a full-scale reading.

Fig. 1 is a simplified circuit of the leakage test. The same circuit protects the meter against burnouts since the meter is never inserted directly into the

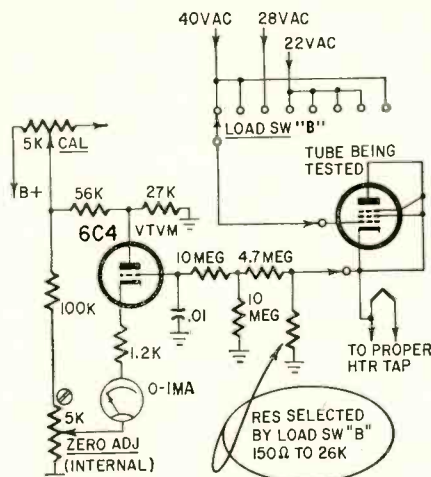

Fig. 2—Emission test circuit of the Mighty Mite.

tested tube's circuit.

The Mighty Mite does not check tube gain. Tubes are checked for cathode emission which, along with leakage and short tests, generally gives ample information for judging tube quality, except for the fairly remote possibility of open elements.

During the emission check, all tube elements are tied to the cathode except the grid (plate in diodes). Depending on the position of LOAD switch B, either

22, 28 or 40 volts ac is applied to the grid (plate in diodes) of the tube being tested. LOAD switch B also selects a cathode resistor of 150 to 26,000 ohms. The voltage drop across this resistor (which represents cathode emission) is applied to the internal 6C4 vtvm circuit and the meter is deflected accordingly (Fig. 2). Rectifier tubes such as 5U4's are checked using a low-value cathode resistor so that up to 150 ma is passed through the tube during test. This produces a much more accurate indication of quality.

In addition to the sensitive grid-leakage test and the emission test, the Mighty Mite also has a conventional short-circuit test circuit consisting of a neon bulb in series with an ac voltage. By rotating setup switch D, each individual element can be checked against all others for shorts up to 50,000 ohms. An H-K position lets you identify a heater-cathode short. Fig. 3 is a simplified diagram of the short-test circuit.

We found the Mighty Mite a useful checker. Its small size makes it the ideal "carry" tester. The setup procedure is simple and comparatively fast.

The TC109 also checks picture-tube emission as well as 12-volt hybrid auto

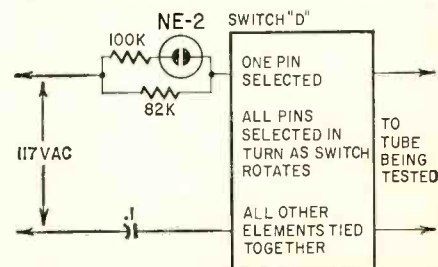

Fig. 3—This basic tube-element short test is built into the Sencore tester.





# Let RCA Train You in Electronics

Start Your Career Now at RCA INSTITUTES in LOS ANGELES or NEW YORK

RCA Institutes is one of the largest technical institutes in the United States devoted exclusively to electronics. Free Placement Service. Applications now being accepted for next term classes in Los Angeles and New York. You can choose from this broad selection of courses.

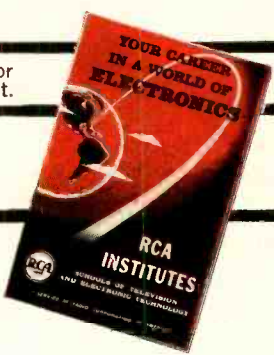
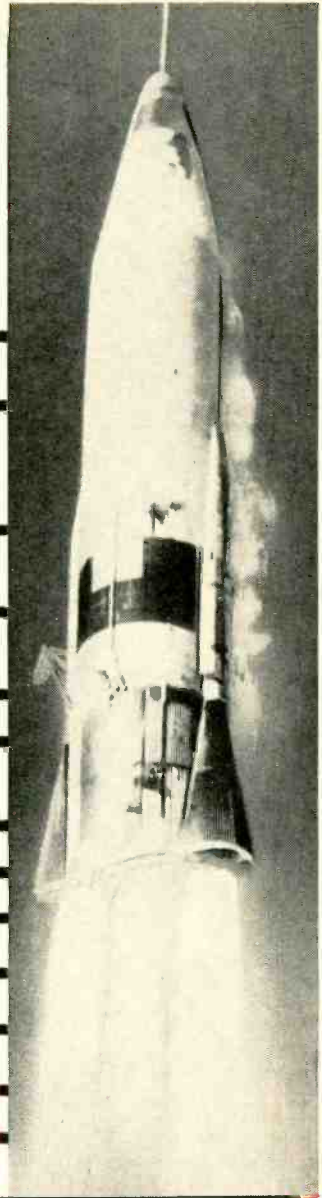

Name of Course	Qualifications	Day and/or Evening Course	Length of Course
A. Advanced Electronics Technology (T-3)	High School Graduation including Algebra (1½ years) and Physics or Science or equivalent training	Day Evening	2¼ years 6¾ years (N.Y.) 4½ years (L.A.)
B. Television and General Electronics (V-7)	2 years of High School including Algebra, Physics or Science	Day Evening	1½ years 4½ years (N.Y.) 3 years (L.A.)
C. Radio and Television Servicing (V-3)	2 years of High School including Algebra, Physics or Science	Day Evening	9 months 2¼ years (N.Y.) 1½ years (L.A.)
D. Transistors	Radio background	Eve. only	3 months
E. Electronic Drafting (V-11 and V-12)	2 years of High School including Algebra, Physics or Science	Eve. only	Basic: 1 Year Advanced: 2 Years
F. Color Television	Television background	Eve. only	3 months
G. Audio-Hi Fidelity	Radio background	Eve. only	3 months
H. Computer Programming (C-1)	College Graduate or Industry sponsored.	Eve. only	24 Weeks
I. Technical Writing (V-10)	High School Graduate	Eve. only	2¼ years (N.Y.) 1½ years (L.A.)
J. TV and Radio Studio Production (S-1)	High School Graduate	Day Evening	15 Weeks 45 Weeks
K. Digital Computers	Electronics background	Eve. only	3 months (L.A.)
L. Preparatory Math & Physics (P-O)	1 Year High School	Day only	3 months
M. Preparatory Mathematics (P-OA)	1 Year High School	Eve. only	3 months
N. Home Study Courses	Choose from: Radio and Electronic Fundamentals, TV Servicing, Color TV, Transistors, and Automation Courses. Catalog free on request.		

Coeducational day and evening courses start 4 times each year  
**SEND COUPON FOR FREE RESIDENT SCHOOL CATALOG**



**RCA INSTITUTES, INC.**  
 A Service of Radio Corporation of America  
 The Most Trusted Name in Electronics

For **LOS ANGELES SCHOOL** send this coupon

For **NEW YORK CITY SCHOOL** send this coupon

**RCA Institutes, Inc. ZRER-61**  
 Pacific Electric Building, 610 South Main St., Los Angeles 14, Calif.

Please send me without obligation your free 64 page illustrated Resident School catalog. I have circled below the courses that interest me.

A B C D E F G H I J K L M N

Name \_\_\_\_\_

Address \_\_\_\_\_

City \_\_\_\_\_ Zone \_\_\_\_\_ State \_\_\_\_\_

**RCA Institutes, Inc. ZRER-61**  
 350 West 4th St., New York City

Please send me without obligation your free 64 page illustrated Resident School catalog. I have circled below the courses that interest me.

A B C D E F G H I J K L M N

Name \_\_\_\_\_

Address \_\_\_\_\_

City \_\_\_\_\_ Zone \_\_\_\_\_ State \_\_\_\_\_

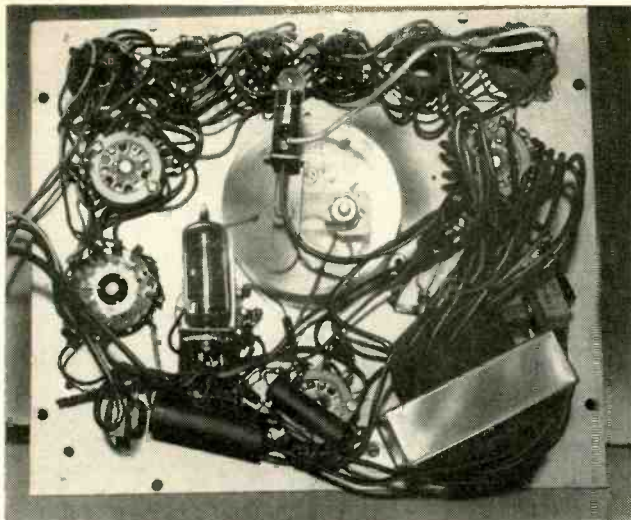

Inside view shows the TC109's works.

tubes, battery and foreign types. Dual tubes are checked independently both for emission and grid leakage.

#### B&K model 600

This is a recent addition to the B&K line. It features an adjustable metered grid-emission check similar to previous B&K checkers. The adjustment is factory-set for 25 megohms leakage but may be reset by the user to over 100-megohm sensitivity. Simplified circuitry of this test is shown in Fig. 4. The meter is in the plate circuit of the triode section of the 6BN8 dc amplifier (vtvm) when the grid emission button is depressed. The 6BN8 is biased just at cutoff so that there is normally no meter

reading. However, leakage from any elements to the grid of the tube being tested lowers the bias on the 6BN8, and it conducts, producing a deflection on the meter. A separate grid-emission test must be made for each section of multi-section tubes.

A simplified schematic of the short test is shown in Fig. 5. Short tests between the grid and all other tube elements are made as soon as the tube is inserted. By rotating switch C you check each element of the tube against all other elements with a leakage sensitivity to approximately 1 megohm.

After making both the grid-leakage and short checks, you test cathode emis-

sion by depressing the quality button. This ties all the elements of the tube, except the grid, to ground (Fig. 6). The grid is tied to a 60-volt tap on the power transformer. The tested tube acts as a half-wave rectifier (the grid acting as the anode) and the current output, corresponding to cathode emission, is measured by the meter. Control A is a shunt across the meter so that the tester may be set up for the many tube types tested.

The B&K tester does not test picture tubes but it does provide for testing the recently released "nonstandard" socket tubes: nuvistors, Compactrons and 10-pin types. It also tests local tubes. END

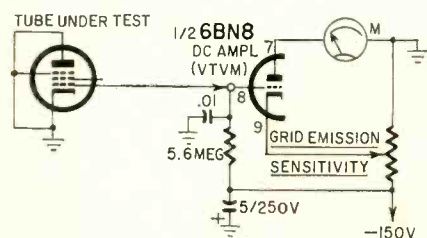

Fig. 4—Simplified circuit of the grid-emission test used in the B&K model 600.

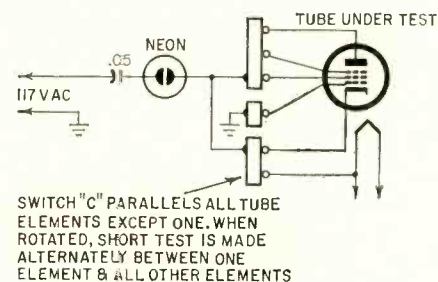

Fig. 5—B&K uses this arrangement to check for interelement shorts.

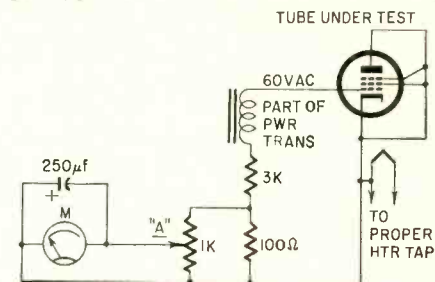
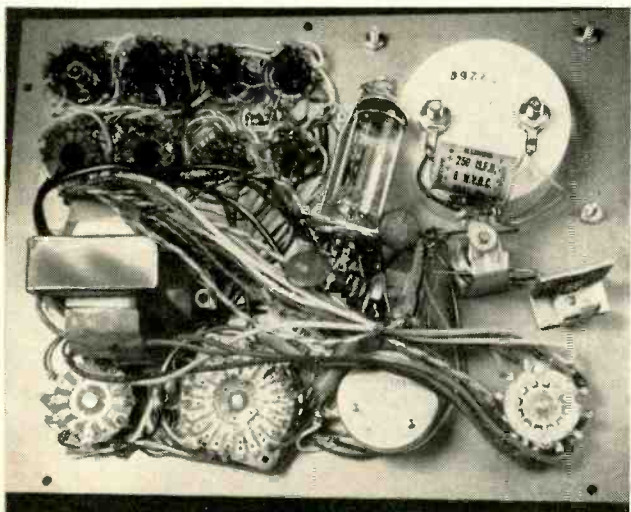

Fig. 6—Tube quality is checked with this circuit in the model 600.



A lot of good things are packed into the 600's chassis.

#### VITAL STATISTICS B&K Model 600 Dyna-Quik Tube Tester

PRICE—\$69.95

**ELECTRICAL FEATURES**—Emission quality check, neon short check, adjustable metered grid-emission check. Four setup controls.

**CABINET**—Covered wood and Masonite construction. Lid not removable. 8½ x 11 x 4½ inches lid closed.

**TUBE TYPES TESTED**—Radio and TV types using octal, local, 7-, 9- and 10-pin sockets; miniature; 12-pin Compactron and nuvistor. Many foreign and industrial types.

**METER SIZE**—3½ x 4½ inches.

**SPECIAL FEATURES**—Pin straighteners, carrying handle. Checks shorts between all elements by rotating setup switch.

Never before so much performance, versatility and styling in a speaker as small in size as it is in price!

## NEW ELECTRO-VOICE

# PA 15



Model PA15 (8-ohms) \$30.00 List  
Model PA15-45 (45-ohms) \$31.25 List  
Model PA15T (70.7-volt transformer) \$36.00 List

### Small enough to be hidden . . . with a voice that can't be missed!

Now, from Electro-Voice—home of major PA speaker improvements since World War II—comes the most effective solution to many sound problems. It's the exciting new PA15! Features a driver located right up front—in the horn mouth itself—to eliminate one of the “bends” of ordinary reentrant horns . . . and to

insure wider range and smoother high frequency response!

And the PA15 is uniquely easy to install and service. Special swivel mount permits installation anywhere . . . while the driver's front location makes field replacement unusually quick and simple. Installations are neater, too, when you use the PA15T with its optional 70.7-volt transformer built right in!

### Better check these other PA15 features:

- Modest size (6" x 9" x 9½") to fit anywhere.
- Highest power-handling capacity in its class.
- Smoothly rising response for better penetration, less feedback.
- Rectangular shape for best dispersion, minimum wasted power.
- 8-ohm or 45-ohm impedances available.

#### ELECTRO-VOICE, INC.

Commercial Products Division, Dept. 616E  
Buchanan, Michigan

FURTHER PROOF THE SMART MOVE IS TO ELECTRO-VOICE!



Write for full specs  
on the PA15 today!

[www.americanradiohistory.com](http://www.americanradiohistory.com)

# Electro-Voice®

# Transistor intercom fills many needs

Lightweight portable unit is useful for antenna installations, keeps tabs on the baby, connects office to office, or shop to house

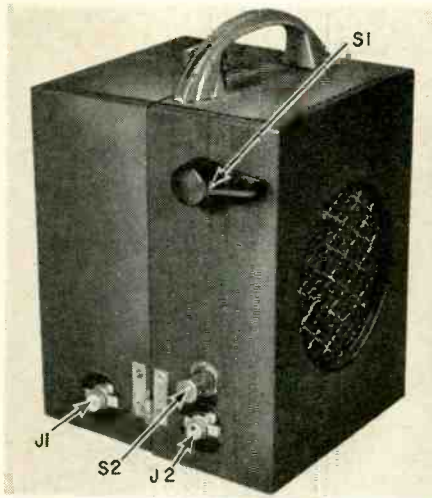

Slip hinges hold the master and remote units together to make one easy-to-carry package.

By HOMER L. DAVIDSON

HERE is a compact transistor intercom that can be used in the home, office or shop. The unit will listen in on the baby, provide communications between home and the shop or from office to office. It can also be used in TV antenna installations, for which it was originally intended.

The unit is battery-powered, making it completely portable, and as transistors are used there is no wait for it to warm up. The master and remote units are equipped with slip hinges to hold them together and form one easy-to-carry unit, complete with handle.

The intercom's circuit (see diagram) is very simple. Two GT-81 transistors with a capacitance input and transformer coupling make up the works. The output of a 4-inch 45-ohm speaker, also used as a microphone, is fed directly through a dpdt momentary contact

switch (S1) to V1's base. The base resistor (R1) is returned to -15 volts. A miniature SO-3 interstage transformer couples the two transistor stages. V2's output is connected to a universal output transformer. The proper primary taps are determined by experimenting with various combinations and selecting the taps that provide the clearest and loudest output. The output transformer's secondary is matched to another 45-ohm speaker and connected to it through the dpdt switch.

Both transistors have grounded emitters. V1 draws about 0.3 ma and V2 about 4 ma when no signal is present. Adjust the base-return resistors for best signal quality and clarity as well as current drain. As the transistors are wired directly into the circuit, their leads are not cut, but are covered with fine spaghetti to protect against possible shorts.

Placement of parts is not critical, although they should be mounted in a way that will keep wiring simple. A small sheet of aluminum is bolted to the speaker frame and is used as a chassis. The output transformer is mounted on top of this chassis. All small components, including the transistors, are placed under the chassis as they are soldered into the circuit. A

perforated bakelite board could also be used for the chassis.

The switches are mounted on the side of the case along with the connecting jack. I used phono jacks to provide convenient connections. The cords can be rolled up and carried separately and there is no danger of breaking or twisting the leads where they come out of the intercom box.

The intercom cases are made from 1/4-inch plywood held together with glue and wire brads. Pick up a handle at any dime or hardware store.

Both units are equipped with small slip hinges at each side so they slip together for easy carrying. A loose-pin hinge was added across the top of the two cases as a catch to prevent them from slipping apart. The pin is removed when fastening or disconnecting the cases. A short length of thin chain or flexible wire may be soldered to the pin to prevent it from being mislaid.

The intercom is easy to use. Simply connect the master and remote together, and turn the master unit on. If they are working properly and set close together, a feedback whistle will be heard. There is no volume control since gain is not too high, although a person can be heard within 10 feet of either unit. END

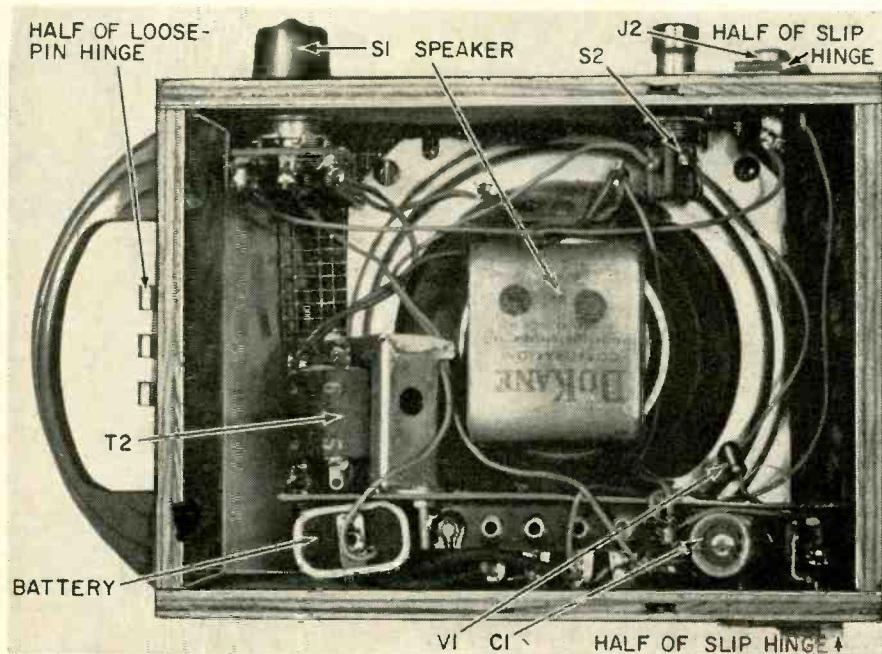

Back view of master-unit case shows parts layout.

- R1, 2—470,000 ohms, 1/2 watt, 10%
- C1—50  $\mu$ f, 50 volts, electrolytic
- C2—25  $\mu$ f, 50 volts, electrolytic
- J1, 2—phono jacks
- P1, 2—phono plugs
- S1—dpdt, spring return, rotary
- S2—sps, pushbutton or toggle
- T1—interstage transformer: primary, 10,000 ohms; secondary, 200 ohms (UTC SO-3 or equivalent)
- T2—universal output transformer (Merit A-2900 or equivalent)
- V1, 2—GT-81
- Battery, 15 volts
- Speakers, 45 ohms, 4 inches (2)
- Chassis
- Cabinets (2)
- Handle
- Slip hinges (2)
- Miscellaneous hardware

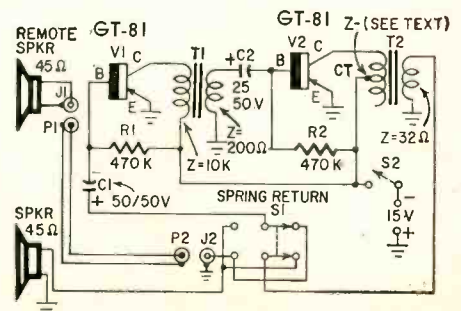

Circuit of 2-transistor unit.

## A curious trouble

THE complaint on a Hoffman Chassis 175 was no sound or picture. The rectifier was good, so I checked tuner and video if tubes—all were good. I connected the signal generator to the control grid of the first video if amplifier, injected signal and tried to get modulation bars in the picture tube. It didn't work.

I noticed that with a low-amplitude signal, the audio portion of a broadcast could be heard, though very distorted. The set has a TV-PHONO SWITCH and with the switch in its PHONO position, the audio was much louder!

On a hunch, I checked the agc voltage. Sure enough, instead of the -0.1 volt called for at the control grid of the first video if, there was -10 volts. All resistance values were OK. I disconnected the agc line, and substituted a variable negative voltage, but even with the correct negative voltage I still had no picture, and best audio with the phono switch in.

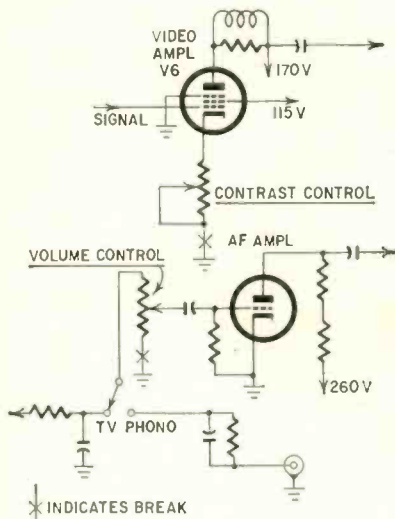

All voltages in the video string were OK with the exception of the agc. I continued injecting signals till I passed the sound takeoff, with no sign of modulation bars on the CRT screen.

The next day I tackled the monster again. While waiting for the set to warm up, I noticed that the volume control had a loose mounting nut, after tightening the nut, I wriggled the shaft around to make sure the pot was tight. Simultaneously, the raster showed some video. The pot was similar to that used on many TV sets—a combination of contrast, volume and on-off switch. Then I noticed a break in the ground wire.

Sure enough, restoring the ground connection cleared up all the troubles! Even the phono switch worked OK. Before, the audio had a partial ground in the PHONO position. The agc had been loaded down enough when the signal generator was hooked on it to remove the cutoff bias and allow the tubes to conduct.—Wendell Titmus

JUNE, 1961

## Now Completely SELF-CONTAINED

For Testing & Rejuvenating  
BLACK AND WHITE and COLOR including 110° TUBES

### NEW CRT 440



#### TESTS AND REJUVENATES

all black & white and color picture tubes at correct filament voltage from 1 to 12 V.

#### TESTS AND REJUVENATES

110° tubes with 2.34, 2.68, 6.3 and 8.4 volt filaments.

#### TESTS AND REJUVENATES

color picture tubes. Checks each color gun separately some as black & white tubes.

Used by Thousands of Professional Servicemen  
MAKES NEW PICTURE TUBE SALES EASIER

Gives you more value than ever—all-in-one. Quickly checks and corrects most TV picture tube troubles in a few minutes right in the home without removing tube from set. Gives new useful life to weak or inoperative tubes. Checks leakage. Restores emission and brightness. Repairs inter-element shorts and open circuits. Life test checks gas content and predicts remaining useful life of picture tube. Completely self-contained in leatherette-covered carrying case. Net, \$74<sup>95</sup>

#### ACCESSORIES for USE ONLY with FORMER B&K Models 400 and 350 CRT



**Model C40 Adapter.** For use only with all previous B&K Model 400 and 350 CRT's. Tests and rejuvenates TV color picture tubes and 6.3 volt 110° picture tubes. Net, \$9.95

**Model CR48 Adapter.** For use only with all previous B&K Model 400 and 350 CRT's. Tests and rejuvenates 110° picture tubes with 2.34, 2.68, and 8.4 volt filaments. Net, \$4.95



See your B&K Distributor  
or Send now for Bulletin AP17-E

#### B & K MANUFACTURING CO.

1801 W. BELLE PLAINE AVE • CHICAGO 13, ILL.  
Canada: Atlas Radio Corp., 50 Wingold, Toronto 19, Ont.  
Export: Empire Exporters, 277 Broadway, New York 7, U.S.A.

## TAPE RECORDERS



#### HI-FI COMPONENTS SLEEP LEARN KITS

Unusual Values  
Free 1961  
Catalog  
**DRESSNER,**  
1523RE Jericho Tpke, New Hyde Park, N.Y.

**MERITAPE**  
Low cost, high  
quality recording  
tape, in boxes or cans.  
on your component needs.



#### YOU'LL BE AMAZED...

at our low, low hi-fi prices.  
Write for FREE discount catalog  
A-12, or send for our special  
quotations on your component needs.

**KEY ELECTRONICS COMPANY**  
120 Liberty St., New York 6, N.Y.

Cat. No. 52

## NEW! STRAP-LESS Chimney Mount



- Installs In Seconds
- No Chimney Too Large
- Can't Rust Away
- Up To 1,500 lbs Clamping Pressure

DEALER NET PRICE \$1.25 Write for literature. Ask for bulletin R-C

**R-Columbia Products Co., Inc.**  
2008 St. Johns Ave. Highland Park, Illinois

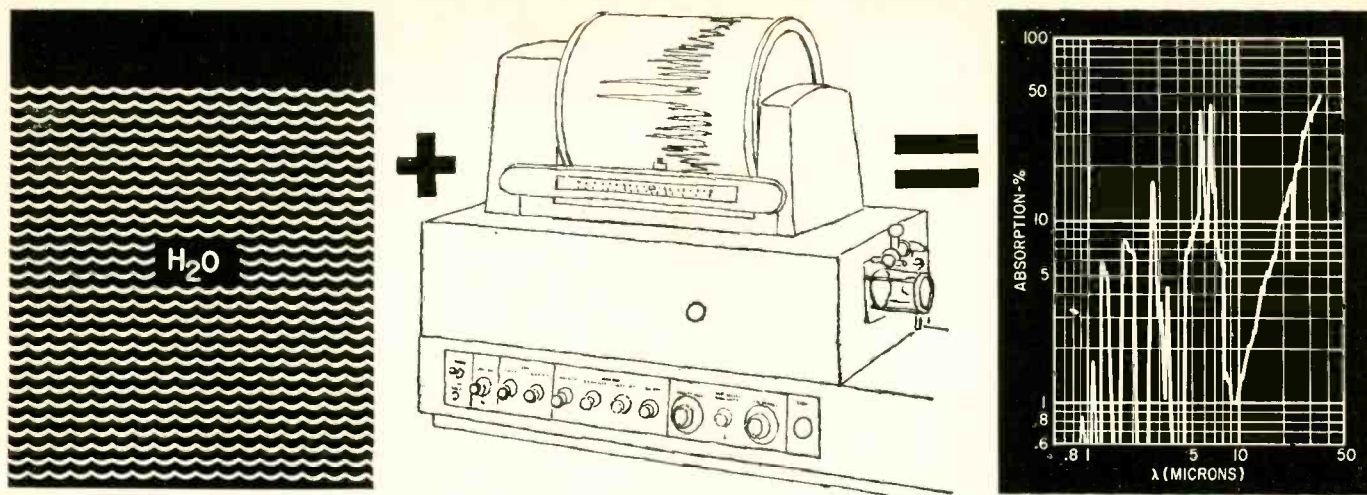

Fig. 1—Absorption spectrum of water vapor.

# INFRARED *spectroscopy*

**Accurate chemical analysis uses infrared rays**

By **BARRON KEMP**

**S**PECTROSCOPY is the oldest and most common industrial application of infrared energy. Infrared-absorption spectroscopy takes advantage of the fact that molecules of all substances vibrate at frequencies which are set by their atomic mass, type of chemical bond and molecular geometry. Most of these frequencies are in the infrared portion of the electromagnetic spectrum.

Therefore, infrared energy can be used to determine quickly the type of organic chemicals in a sample of material to provide means for controlling chemical reactions and to discover new substances. Because of these qualities, infrared is vital to many phases of industry.

## The molecule

A molecule is the smallest particle of any substance that can exist alone and have all the chemical properties of the substance. All molecules are composed of atoms connected by electrostatic forces called "chemical bonds." These atoms are in continuous motion with respect to each other because of the thermal agitation in any substance whose temperature is above absolute zero ( $-273^{\circ}\text{C}$ ). This motion of the atoms changes abruptly from one energy level to another. Such changes cause absorption or radiation of energy, most of which is in the infrared portion of the spectrum. Each molecule of a sub-

stance generates specific frequencies for the atomic motion within it. Two identical molecules have the same atomic structure and generate the same frequencies. Two different molecules have different atomic structures and generate (or absorb) different frequencies.

The radiation absorbed or emitted because of these molecular vibrations is called "molecular spectra." Such spectra are characterized by specific wavelengths representing radiation of definite energy values. When the molecular spectra are measured, they appear as well defined values that follow a definite order for each type of molecule. The study of these wavelengths and their order or grouping furnishes much information on the structure and internal mechanics of molecules (Fig. 1).

## Infrared and the molecule

An energy exchange occurs when infrared energy is transmitted through a thin sample of a material. Molecules of the material absorb, in varying degrees, the infrared frequencies which are characteristic of the material. Only those frequencies of the transmitted infrared energy that are similar to the characteristic frequencies of the molecular bonds (chemical bonds) of the material are absorbed. The rest are unaffected.

This effect of energy absorption by molecules makes it possible to plot curves which are characteristic of the material being irradiated; their exact location in the electromagnetic spectrum

can be measured for positive identification of the material.

The infrared spectra of two types of chloroform solution are given in Fig. 2. Examination shows certain definite similarities and differences between them. Both show energy absorption at 3.4 microns, indicating that both solutions have common molecules. Also, both show absorption in varying degrees between 7.8 and 10 microns, also indicating the presence of similar molecular structure.

Infrared analysis of any sample of a solution will always show the same spectra, no matter how many times the measurements are made. However, whenever the composition of a solution differs because of the presence or absence of any chemical, infrared analysis will indicate the difference.

Since the infrared spectrum of a material is its most characteristic physical property, infrared analysis finds extensive application in identifying unknown materials. By matching the infrared spectra of an unknown material with that of a known one, the identity of the unknown material is proved. Similar materials have the same vibrational frequencies, therefore, similar spectra. Different materials have different vibrational frequencies, so yield different spectra.

From this simple comparison of known and unknown spectra comes the usefulness of infrared to the chemist. Matching the infrared spectra of an unknown with that of a known material is accepted as chemical proof



there are trumpets



and there are trumpets!

Which is another way of saying: *don't use a boy for a man's job!* Here are five performance- and time-proven features of University's loudspeaker trumpets that add up to complete coverage, top efficiency and life-long dependability: [1] the greatest choice of models in the industry, making possible the right solution to every public address installation problem. [2] Patented designs that result in maximum output, cutting power requirements and assuring lowest dollar-per-watt costs to the user. [3] Heavy gauge metals and rubber rim damping for positive elimination of acoustic resonances. [4] Electroplating, spraying and then baking of all parts guarantee peel-proof, destruction-proof finishes against all the elements. [5] Exclusive rib-reinforced heavy gauge steel "U" mounting bracket with fully adjustable serrated swivel joints and self-locking, positive grip nut for easy installation. Now pair up the exact model you need with a man-sized driver unit from University's complete line—ranging from 20 to 60 watts—and you'll hit that high note every time. For complete details on all University public address speakers and accessories, write Desk J-6, University Loudspeakers, Inc., 80 So. Kensico Avenue, White Plains, N. Y.

A SELECTION OF NINE TRUMPET MODELS FOR TOTAL INSTALLATION FLEXIBILITY



4 DIFFERENT DIRECTIONAL REFLEX MODELS

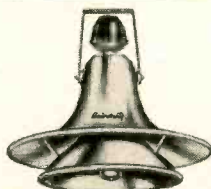

3 DIFFERENT RADIAL REFLEX MODELS

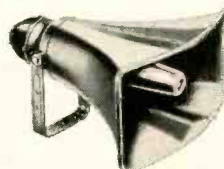

2 DIFFERENT WIDE-ANGLE REFLEX MODELS



WORLD'S LARGEST MANUFACTURER OF PUBLIC ADDRESS SPEAKERS

A Division of Ling-Temco Electronics, Inc.



of the identity of an unknown material.

The spectra of a mixture of several types of molecules is essentially the superposition of the spectra of the different molecules. Not only can the components of a mixture be identified, but their concentrations can be quickly and accurately determined as well.

### The infrared spectroscope

No single analytical tool has had a more dramatic impact upon organic chemistry than infrared measurement. The development of many types of instruments for producing and viewing infrared spectra permits a degree of analysis and control that was impossible just a few years ago.

The earliest and simplest infrared instrument is the spectroscope (Fig. 3). The earliest ones were adaptations of Newton's discovery of the dispersion of the short wavelengths of electromagnetic radiation by a prism. This simple device has been improved and modified by modern industry so that many types of instruments are now available for viewing infrared spectra. However, the most modern of them still operate according to Newton's principles of the dispersion of radiation by a prism.

The spectroscope consists of a source of radiant energy (a rod heated electrically to about 1,200°C which emits all infrared frequencies), a prism that disperses these frequencies in space, a slit system to isolate each frequency, a detector to measure the amount or

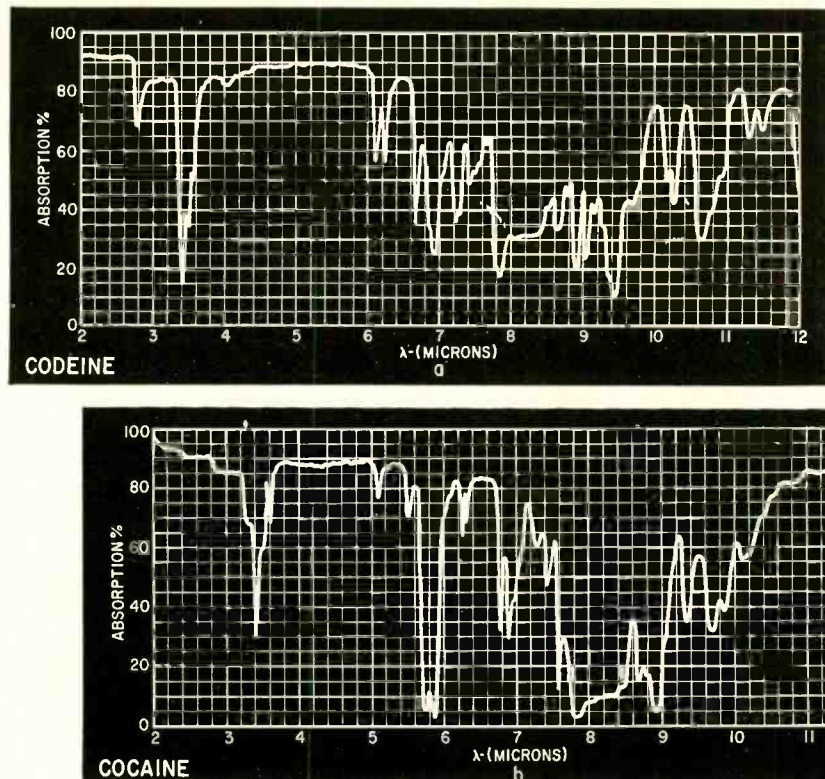

Fig. 2—Absorption spectra of two chloroform solutions: a—codeine; b—cocaine.

intensity of the radiation, an amplifier to increase the magnitude of the output signal of the detector, and a method of recording the output of the amplifier.

Infrared radiation automatically passes through the components in the order named. The dispersed radiation passes from the source through the

## EXAMINE ANY OF THESE TESTERS BEFORE YOU BUY

SUPERIOR'S NEW MODEL 85 TRANS-CONDUCTANCE TYPE

### TUBE TESTER

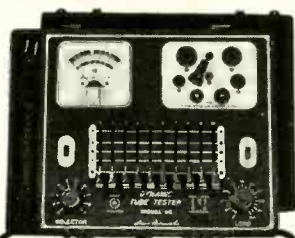

Model 85—Trans-Conductance Tube Tester. Total Price...\$52.50  
Terms: \$12.50 after 10 day trial, then \$8.00 monthly for 5 months if satisfactory. Otherwise return, no explanation necessary.

• FREE FIVE (5) YEAR CHART DATA SERVICE. Revised up-to-date subsequent charts will be mailed to all Model 85 purchasers at no charge for a period of five years after date of purchase.

Model 85 comes complete, housed in a handsome portable cabinet with slip-on cover. Only **\$52.50**

• Employs latest improved TRANS-CONDUCTANCE circuit. Test tubes under "dynamic" (simulated) operating conditions. An in-phase signal is impressed on the input section of a tube and the resultant plate current change is measured as a function of tube quality. This provides the most suitable method of simulating the manner in which tubes actually operate in radio, TV receivers, amplifiers and other circuits. Amplification factor, plate resistance and cathode emission are all correlated in one meter reading.

• SYMBOL REFERENCES: Model 85 employs time-saving symbols (•, +, •, ▲, ■) in place of difficult-to-remember letters previously used. Repeated time-studies proved to us that use of these scientifically selected symbols speeded up the element switching step. As the tube manufacturers increase the release of new tube types, this time-saving feature becomes necessary and advantageous.

• "FREE-POINT" LEVER TYPE ELEMENT SWITCH ASSEMBLY marked according to RETMA basing, permits application of test voltages to any of the elements of a tube.

SUPERIOR'S NEW MODEL 82A

Multi-Socket Type

### TUBE TESTER



Model 82A—TUBE TESTER  
Total Price .....\$36.50  
Terms: \$6.50 after 10 day trial, then \$6.00 per month for 5 months if satisfactory. Otherwise return, no explanation necessary.

Don't let the low price mislead you! We claim Model 82A will outperform similar looking units which sell for much more — and as proof, we offer to ship it on our examine before you buy policy.

Model 82A comes housed in handsome, portable Saddle-Stitched Texon case. Only **\$36.50**

TEST ANY TUBE IN 10 SECONDS FLAT!

- 1 Turn the filament selector switch to position specified.
- 2 Insert tube into a numbered socket as designated on our chart (over 600 types included).
- 3 Press down the quality button—

THAT'S ALL! Read emission quality direct on bad-good meter scale.

#### SPECIFICATIONS

- Tests over 600 tube types
- Tests OZ4 and other gas-filled tubes
- Employs new 4" meter with sealed air-damping chamber resulting in accurate vibrationless readings
- Use of 22 sockets permits testing all popular tube types and prevents possible obsolescence
- Dual Scale meter permits testing of low current tubes
- 7 and 9 pin straighteners mounted on panel
- All sections of multi-element tubes tested simultaneously
- Ultra-sensitive leakage test circuit will indicate leakage up to 5 megohms

## DID YOU EVER

- Order merchandise by mail, including deposit or payment in full, then wait and write... wait and write?
- Purchase anything on time and sign a lengthy complex contract written in small difficult-to-read type?
- Purchase an item by mail or in a retail store then experience frustrating delay and red tape when you applied for a refund?

Obviously prompt shipment and attention to orders is an essential requirement in our business... We ship at our risk!





prism and across the slit. The detector absorbs each wavelength of radiation, producing an electrical output signal proportional to the intensity of radiation from the source. The electrical signal is amplified and operates a viewing or recording device to permit visual observation of the spectra.

Characteristic frequencies of a material are measured by passing all frequencies of the infrared spectrum through it—scanning the spectrum. This is done with a slit or grating which permits only one frequency at a time to reach the detector. The output of the detector varies in amplitude according to the absorption of the molecules of the material. The recorded output of the detector indicates the absorption and transmission properties of the material at all infrared frequencies.

A reference graph may be plotted by recording the infrared energy transmitted from the source with no sample between the source and prism. This graph then represents the total energy radiated at all wavelengths of the infrared spectrum.

If a sample of material is then introduced and this process repeated, a spectrum is produced which is the same as the reference spectrum except at those frequencies where molecules of the sample are vibrating. The detected signal is weakened by the absorption of the sample at these characteristic frequencies. Comparison of the reference and sample spectra reveals ampli-

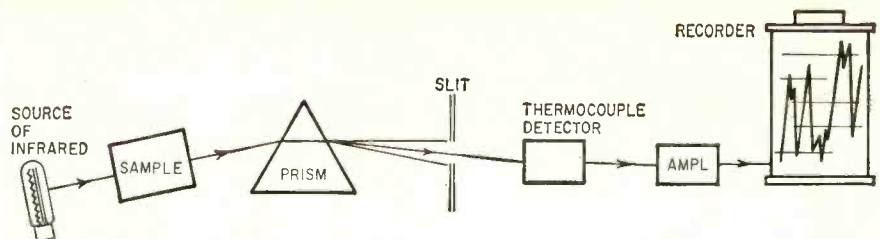

Fig. 3—Operating principle of a basic spectroscope.

Perkin-Elmer Corp.

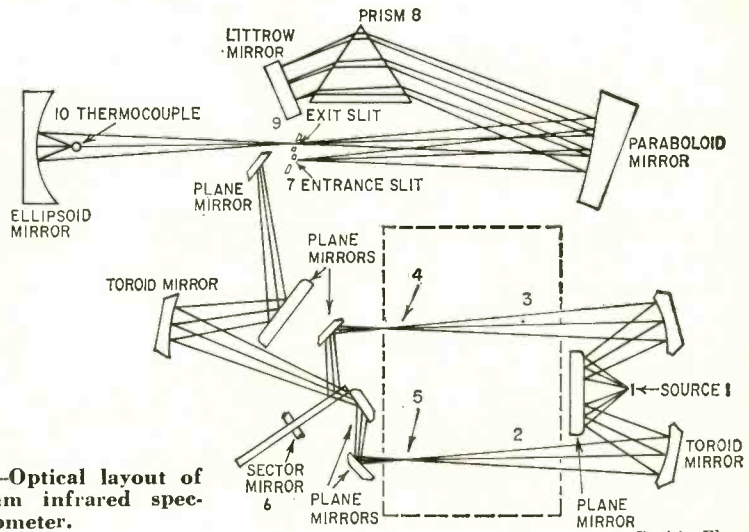

Fig. 4—Optical layout of dual-beam infrared spectrophotometer.

Perkin-Elmer Corp.

**YES, WE OFFER TO SHIP AT OUR RISK ONE OR MORE OF THE TESTERS DESCRIBED ON THESE PAGES AND FOLLOWING PAGES**

SUPERIOR'S NEW MODEL 83A

**C.R.T. TESTER**  
Tests and Rejuvenates ALL PICTURE TUBES

**ALL BLACK AND WHITE TUBES**  
From 50 degree to 110 degree types  
—from 8" to 30" types.

**ALL COLOR TUBES**

Test ALL picture tubes—in the carton—out of the carton—in the set!

Model 83A provides separate filament operating voltages for the older 6.3 types and the newer 8.4 types.

Model 83A properly tests the red, green and blue sections of color tubes individually — for each section of a color tube contains its own filament, plate, grid and cathode. Model 83A will detect tubes which are apparently good but require rejuvenation. Such tubes will provide a picture seemingly good but lacking in proper definition, contrast and focus.

Rejuvenation of picture tubes is not simply a matter of applying a high voltage to the filament. Such voltages improperly applied can strip the cathode of the oxide coating essential for proper emission. The Model 83A applies a selective low voltage uniformly to assure increased life with no danger of cathode damage.

Comes housed in handsome portable Saddle Stitched Texon case —complete with sockets for all black and white tubes and all color tubes. Only... **\$38.50**

Try any of the instruments on this page, the facing page and the following pages—for 10 days before you buy. If completely satisfied then send down payment and pay balance as indicated on coupon. No Interest or Finance Charges Added! If not completely satisfied return unit to us, no explanation necessary.

SUPERIOR'S NEW MODEL 88

**TESTS ALL TRANSISTORS AND TRANSISTOR RADIOS**

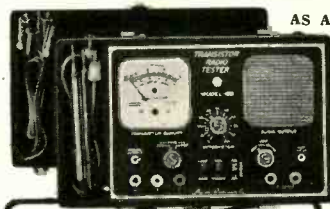

**Model 88 —Transistor Radio Tester and Dynamic Transistor Tester. Total Price...\$38.50**  
Terms: \$8.50 after 10 days trial, then \$6.00 monthly for 5 months if satisfactory. Otherwise return, no explanation necessary.

Comes housed in a handsome portable case. Complete with a set of Clip-On Cables for Transistor Testing, an R.F. Diode Probe for R.F. and I.F. Tracing, an Audio Probe for Amplifier Tracing and a Signal Injector Cable—Only **\$38.50**

**AS A TRANSISTOR RADIO TESTER**  
An R.F. Signal source, modulated by an audio tone is injected into the transistor receiver from the antenna through the R.F. stage, past the mixer into the I.F. Amplifier and detector stages and on to the audio amplifier. This injected signal is then followed and traced through the receiver by means of a built-in High Gain Transistorized Signal Tracer until the cause of trouble is located and pinpointed.

**AS A TRANSISTOR TESTER**

The Model 88 will test all transistors including NPN and PNP, silicon, germanium and the new gallium arsenide types, without referring to characteristic data sheets. The time-saving advantage of this technique is self-evident. A further benefit of this service is that it will enable you to test new transistors as they are released!

MOSS ELECTRONIC, INC., Dept. D-888, 3849 Tenth Ave., New York 34, N. Y.

Please send me the units checked on approval. If completely satisfied I will pay on the terms specified with no interest or finance charges added. Otherwise, I will return after a 10 day trial positively cancelling all further obligations.

- Model 85... Total Price \$52.50 \$12.50 within 10 days. Balance \$8.00 monthly for 5 months.
- Model 87A... Total Price \$36.50 \$6.50 within 10 days. Balance \$6.00 monthly for 5 months.
- Model 83-A... Total Price \$38.50 \$8.50 within 10 days. Balance \$6.00 monthly for 5 months.
- Model 88... Total Price \$38.50 \$8.50 within 10 days. Balance \$6.00 monthly for 5 months.

Name .....

Address .....

City ..... Zone ..... State .....

All prices net, F.O.B. N.Y.C.

Export Division: Rocke International Corp.  
13 East 40th St., New York 16, N. Y.

tude differences at these points. With point-to-point division of the two spectra, the result is a spectrum analysis of the sample—a comparison of the frequency (or wavelength) and intensity of the sample plotted against the frequency (or wavelength) and intensity of the infrared radiation originating from the source.

### The spectrophotometer

Most infrared instruments used for spectroanalysis eliminate the two-step process by using a double infrared beam. Two beams of radiation are transmitted from the source. The sample is placed in one and the other becomes the reference beam. This instrument is called a double-beam spectrophotometer (Fig. 4).

The spectrophotometer measures both beams, automatically divides the value of the sample-beam intensity by that of the reference beam, and plots the ratio of these two beams versus frequency (or wavelength). The electrical output drives a stylus that plots a graph of frequency (or wavelength) along the abscissa and intensity along the ordinate axis.

A typical double-beam spectrophotometer (Fig. 4) radiates energy from a source 1. The energy is divided into two beams; the sample 2 and the reference 3. The source is focused at points 4 and 5. A sample is placed at point 5. An optical attenuator at point 4 modifies the intensity of the reference beam to correspond to that transmitted



Perkin-Elmer Corp. model 221 infrared spectrophotometer.

through the sample. These beams are combined by a rotating sector mirror through the prism 8, is dispersed, reflected back

through the prism by a Littrow mirror (a mirror so placed as to reflect the light through the prism again) and emerges from the exit slit 9 to be condensed on a thermocouple detector 10.

The presence of a sample of material at position (5) may cause a difference

# EXAMINE ANY OF THESE TESTERS BEFORE YOU BUY

SUPERIOR'S NEW MODEL 70 UTILITY TESTER

## FOR REPAIRING ALL ELECTRICAL APPLIANCES • MOTORS • AUTOMOBILES

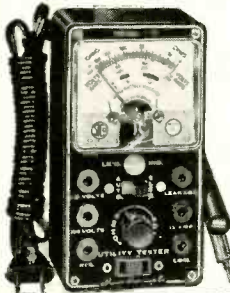

Model 70—Utility Tester

Total Price ..... \$15.85  
Terms: \$3.85 after 10 day trial, then \$4.00 monthly for 3 months, if satisfactory. Otherwise return, no explanation necessary.

As an electrical trouble shooter the Model 70:

- Will test Toasters, Irons, Broilers, Heating Pads, Clocks, Fans, Vacuum Cleaners, Refrigerators, Lamps, Fluorescents, Switches, Thermostats, etc.
- Measures A.C. and D.C. Voltages, A.C. and D.C. Current, Resistances, Leakage, etc.
- Incorporates a sensitive direct-reading resistance range which will measure all resistances commonly used in electrical appliances, motors, etc.
- Leakage detecting circuit will indicate continuity from zero ohms to 5 megohms (5,000,000 ohms).

As an Automotive Tester the Model 70 will test:

- Both 6 Volt and 12 Volt Storage Batteries
- Generators
- Starters
- Distributors
- Ignition Coils
- Regulators
- Relays
- Circuit Breakers
- Cigarette Lighters
- Stop Lights
- Condensers
- Directional Signal Systems
- All Lamps and Bulbs
- Fuses
- Heating Systems
- Horns
- Also will locate poor grounds, breaks in wiring, poor connections, etc.



### INCLUDED FREE

64 page condensed course in electricity. Profusely illustrated. Written in simple, easy-to-understand style.

Model 70 comes complete with book and test leads.

Only

**\$15.85**

SUPERIOR'S NEW MODEL 80

## 20,000 OHMS PER VOLT ALLMETER



Model 80—Allmeter

Total Price ..... \$42.50  
Terms: \$12.50 after 10 day trial, then \$6.00 monthly for 5 months, if satisfactory. Otherwise return, no explanation necessary.

6 INCH FULL-VIEW METER provides large easy-to-read calibrations. No squinting or guessing when you use Model 80.

MIRRORED SCALE permits fine accurate measurements where fractional readings are important.

### SPECIFICATIONS:

- 7 D.C. VOLTAGE RANGES: (At a sensitivity of 20,000 Ohms per Volt) 0 to 15/75/150/300/750/1500/7500 Volts.
- 6 A.C. VOLTAGES RANGES: (At a sensitivity of 5,000 Ohms per Volt) 0 to 15/75/150/300/750/1500 Volts.
- 3 RESISTANCE RANGES: 0 to 2,000/200,000 Ohms. 0-20 Megohms.
- 2 CAPACITY RANGES: .00025 Mfd. to .3 Mfd., .05 Mfd. to 30 Mfd.
- 5 D.C. CURRENT RANGES: 0-75 Microamperes, 0 to 7.5/75/750 Milliampers, 0 to 15 Amperes.
- 3 DECIBEL RANGES: -6 db to +18 db, +14 db to +38 db, +34 db to +58 db.

NOTE: The line cord is used only for capacity measurements. Resistance ranges operate on self-contained batteries.

Model 80 Allmeter comes complete with operating instructions, test leads and portable carrying case. Only .....

**\$42.50**

# DID YOU EVER

- Order merchandise by mail, including deposit or payment in full, then wait and write... wait and write?
- Purchase anything on time and sign a lengthy complex contract written in small difficult-to-read type?
- Purchase an item by mail or in a retail store then experience frustrating delay and red tape when you applied for a refund?

Obviously prompt shipment and attention to orders is an essential requirement in our business... We ship at our risk!



between the amount of energy transmitted by the sample and reference beams, at one or more wavelengths of the infrared spectrum. Any difference between the two beams produces an alternating signal from the thermocouple (10) corresponding in frequency to the rotational frequency of the sector mirror (6) and in amplitude to the amount of radiation falling upon the detector (10). This signal is amplified and used to control a servo motor. The motor moves an optical attenuator (4) which so attenuates the reference beam that its energy equals the energy of the sample beam. The position of this optical attenuator (4) is thereby a measure of the sample transmission of infrared energy at a particular wavelength (or frequency). A spectrum is recorded automatically when the entire band of the infrared region is transmitted through the system; that is, all wavelengths of the infrared region have been transmitted through the sample.

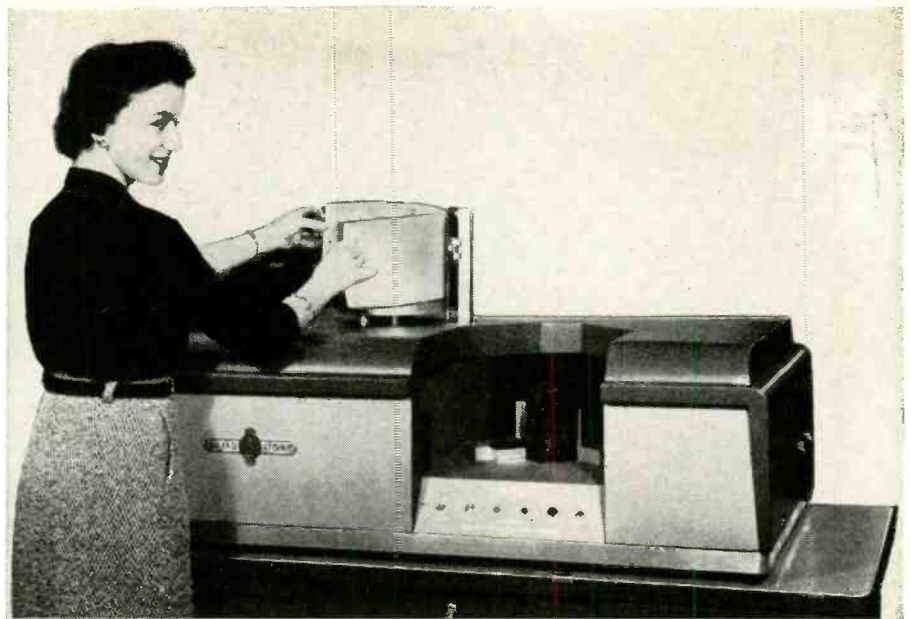

Baird-Atomic model KM-1 infrared double-beam recording spectrophotometer.

**Uses of infrared spectroscopy**

Infrared spectroanalysis gives the chemist a permanent step-by-step record of his work. It provides evidence of dates on which various stages are reached in chemical processes, a record which can be invaluable in patent applications. Furthermore, there is no danger of having too small a sample to process during the next step since infrared analysis is nondestructive and the sample is reusable.

In the control of product purity. The infrared spectroscope plays an important role through all processing stages from raw-material checks through the process of chemical reaction to analysis of the finished product. It is used to establish limits of material acceptance and as a specification of the purity of a product for manufacture.

universities and hospitals, are placing an increased reliance upon infrared analysis. Simple easy-to-operate instruments bring the tool of infrared within easy reach of the one-man-analyst company and small university. With these instruments available, the infrared-absorption technique can reach its full potential value as the most useful of all methods of general chemical analysis.

Infrared spectroscopy is widely used

The chemical, petro-chemical, petroleum and pharmaceutical industries,

END

**YES, WE OFFER TO SHIP AT OUR RISK ONE OR MORE OF THE TESTERS DESCRIBED ON THESE PAGES AND PRECEDING PAGES**

SUPERIOR'S NEW MODEL TV-50A

**GENOMETER**  
7 Signal Generators in One!

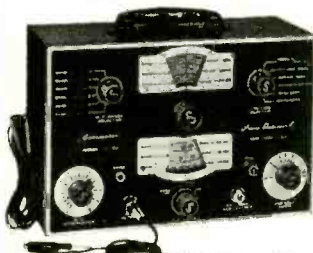

Model TV50-A—Genometer  
Total Price ..... \$47.50  
Terms: \$11.50 after 10 day trial, then \$6.00 monthly for 6 months if satisfactory. Otherwise return, no explanation necessary.

- ✓ R.F. Signal Generator for A.M.
- ✓ R.F. Signal Generator for F.M.
- ✓ Audio Frequency Generator
- ✓ Bar Generator
- ✓ Marker Generator
- ✓ Color Dot Pattern Generator
- ✓ Cross Hatch Generator

A versatile all-inclusive GENERATOR which provides ALL the outputs for servicing:  
A.M. Radio • F.M. Radio • Amplifiers • Black and White TV • Color TV

The Model TV-50A comes complete with shielded leads and operating instructions. Only

**\$47.50**

Try any of the instruments on this page, the facing page and the preceding pages—for 10 days before you buy. If completely satisfied then send down payment and pay balance as indicated on coupon. No Interest or Finance Charges Added! If not completely satisfied return unit to us, no explanation necessary.

SUPERIOR'S NEW MODEL 79

**SUPER-METER**

WITH NEW 6" FULL VIEW METER

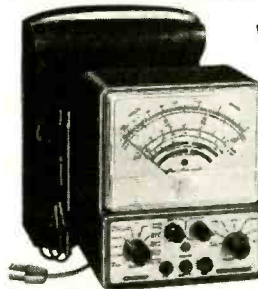

Model 79—Super-Meter  
Total Price ..... \$38.50  
Terms: \$8.50 after 10 day trial, then \$6.00 per month for 5 months, if satisfactory. Otherwise return, no explanation necessary.

**SPECIFICATIONS:** D.C. VOLTS: 0 to 7.5/15/75/150/750/1,500 • A.C. VOLTS: 0 to 15/30/150/300/1,500/3,000 • D.C. CURRENT: 0 to 1.5/15/150 Ma. • 0 to 1.5/15 Amperes • RESISTANCE: 0 to 1,000/100,000 Ohms • 0 to 10 Megohms • CAPACITY: .001 to 1 Mfd. 1 to 50 Mfd. • REACTANCE: 50 to 2,500 Ohms, 2,500 Ohms to 2.5 Megohms • INDUCTANCE: .15 to 7 Henries, 7 to 7,000 Henries • DECIBELS: -6 to +18, +14 to +38, +34 to +58.

The following components are all tested for QUALITY at appropriate test potentials. Two separate BAD-GOOD scales on the meter are used for direct readings: All Electrolytic Condensers from 1 MFD to 1000 MFD • All Selenium Rectifiers • All Germanium Diodes • All Silicon Rectifiers • All Silicon Diodes.

Model 79 comes complete with operating instructions and test leads. Only

**\$38.50**

MOSS ELECTRONIC, INC., Dept. D-888 3849 Tenth Ave., New York 34, N. Y.

Please send me the units checked on approval. If completely satisfied I will pay on the terms specified with no interest or finance charges added. Otherwise, I will return after a 10 day trial positively cancelling all further obligations.

- Model 70 . . . Total Price \$15.85 \$2.85 within 10 days. Balance \$4.00 monthly for 3 months.
- Model 79 . . . Total Price \$38.50 \$8.50 within 10 days. Balance \$6.00 monthly for 5 months.
- Model TV-50A Total Price \$47.50 \$11.50 within 10 days. Balance \$6.00 monthly for 6 months.
- Model 80 . . . Total Price \$22.50 \$12.50 within 10 days. Balance \$6.00 monthly for 3 months.

Name .....  
Address .....  
City ..... Zone ..... State .....

All prices net, F.O.B. N.Y.C.

Export Division: Rocke International Corp., 13 East 40th St., New York 16, N. Y.

# Light-Level indicator

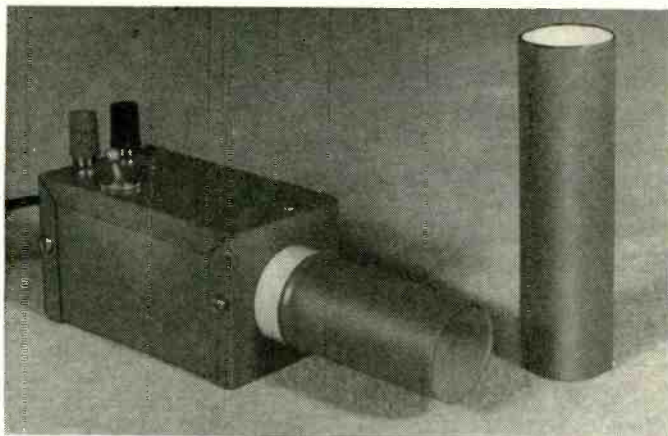

The light-level indicator with its two light shields. The 3-inch shield is in place over the photocell.

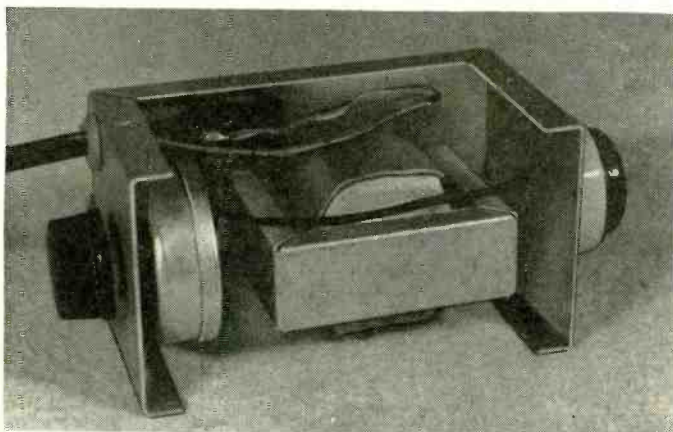

Inside the unit. The transformer, power switch and sensitivity control can be seen.

By HAROLD REED

WITH this light-level indicator you can read varying light intensities on the scale of an audio vtvm. Several useful applications are suggested here. The experimenter will no doubt think of more uses for the device.

For instance, variations in light levels in a room may be noted. You can check light reflections from painted surfaces of different colors or shades. Car headlight balance can also be checked. Even the light intensity from transmitter tuning indicators—such as the No. 47 panel lamp so commonly used to tune amateur and Citizens-band transmitters and antennas—may be observed on an audio vtvm, eliminating the guesswork of watching varying lamp illumination while tuning. Measuring the brightness of TV raster's will aid in making correct adjustment for maximum brightness of raster. Still other uses will

be found in photographic work.

Relatively small amounts of incident light will cause large currents to flow through the cadmium sulphide photoconductive cell when connected in the circuit, as shown in the diagram. Current flow is high enough to make an amplifier unnecessary in many applications, even with small values of incident light. This makes it easy to measure varying light intensities with a standard audio vtvm. The cell is a type NSL-5 produced by National Semiconductors, Ltd., of Canada. It is available from Harvey Radio Co., 103 W. 43rd St., New York 36, N. Y., and probably other sources.

## Circuit data

The internal resistance of the cell varies inversely with the intensity of the light striking its sensitive surface. The circuit is shown in the diagram.

Isolation transformer T is connected to the 117-volt ac supply.

Potentiometer R2, across the secondary of the transformer, acts as a sensitivity control. The variable voltage from this control is impressed across the series-connected photocell and resistor R1. We can read the voltage drop across R1, which varies with incident light intensity, with an audio vtvm. The transformer is included expressly to isolate the line and prevent dangerous shocks.

The light-level indicator is easy to assemble and wire. The few parts are mounted in a 4 x 2 1/4 x 2 1/4-inch case. The photoconductive cell is attached to one end of the box. Drill two small holes for the photocell leads. Slip spaghetti over these leads to prevent shorting to the box. Insulated binding posts are provided for the vtvm connection. The sensitivity control is located on the end of the box opposite the photocell. The ac power switch is above the sensitivity control.

The light shields shown in the photo are useful when observing light from tiny sources. These shields shade the

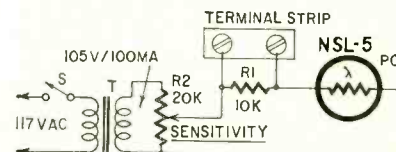

A vtvm connected across resistor R1 reads the light level.

R1—10,000 ohms, 1/2 watt  
R2—pot, 20,000 ohms  
PC—photocell, cadmium sulphide, NSL-5 (see text)  
S—spst toggle  
T— isolation transformer: primary 117 volts; secondary 105 volts, 100 ma (Lafayette TR-91 or other low-power isolation transformer)  
Terminal strip, 2 lugs  
Case, 4 x 2 1/4 x 2 1/4 inches  
Miscellaneous hardware

cell from unwanted light. They are convenient, too, for probing purposes, since the open end of the shield may be thrust right up to a minute light source. Also, small indicator lamps may be placed inside the shield and at various distances from the cell window.

These shields are made from a 1 3/8-inch diameter container cut to 3- and 5-inch lengths. The photocell is mounted in the cover of this container and the assembly attached to the end of the Minibox as shown in the photos. The tubular shields slip easily into the cell-cover assembly when required. It would be preferable to use nonmetallic material for this purpose to avoid possible short circuits or shock hazard when checking light sources.

A 60-watt light bulb, with no reflector, gives a 40-volt reading on the vtvm at a distance of 16 feet. A No. 47 pilot lamp placed near the opening of the 3-inch light shield gave a 100-volt reading. With just 1 volt across the No. 47 lamp (the lamp is barely lit, appearing as just a small red dot about the size of a pinhead), I got a reading of 1.5 volts with the 3-inch light shield. A paper match held to the opening of the 5-inch light shield gave a vtvm indication of 90 volts.

END

## BENCH



## TESTED

This unit turned out to be even more sensitive than expected. For example, it gives a good reading even on a No. 47 pilot lamp behind a red jewel. It also detects small changes in brightness that the human eye (the tester's) cannot notice.

# DIPPED AND MOLDED MYLAR\* CAPACITORS AND SUBMINIATURE ELECTROLYTICS

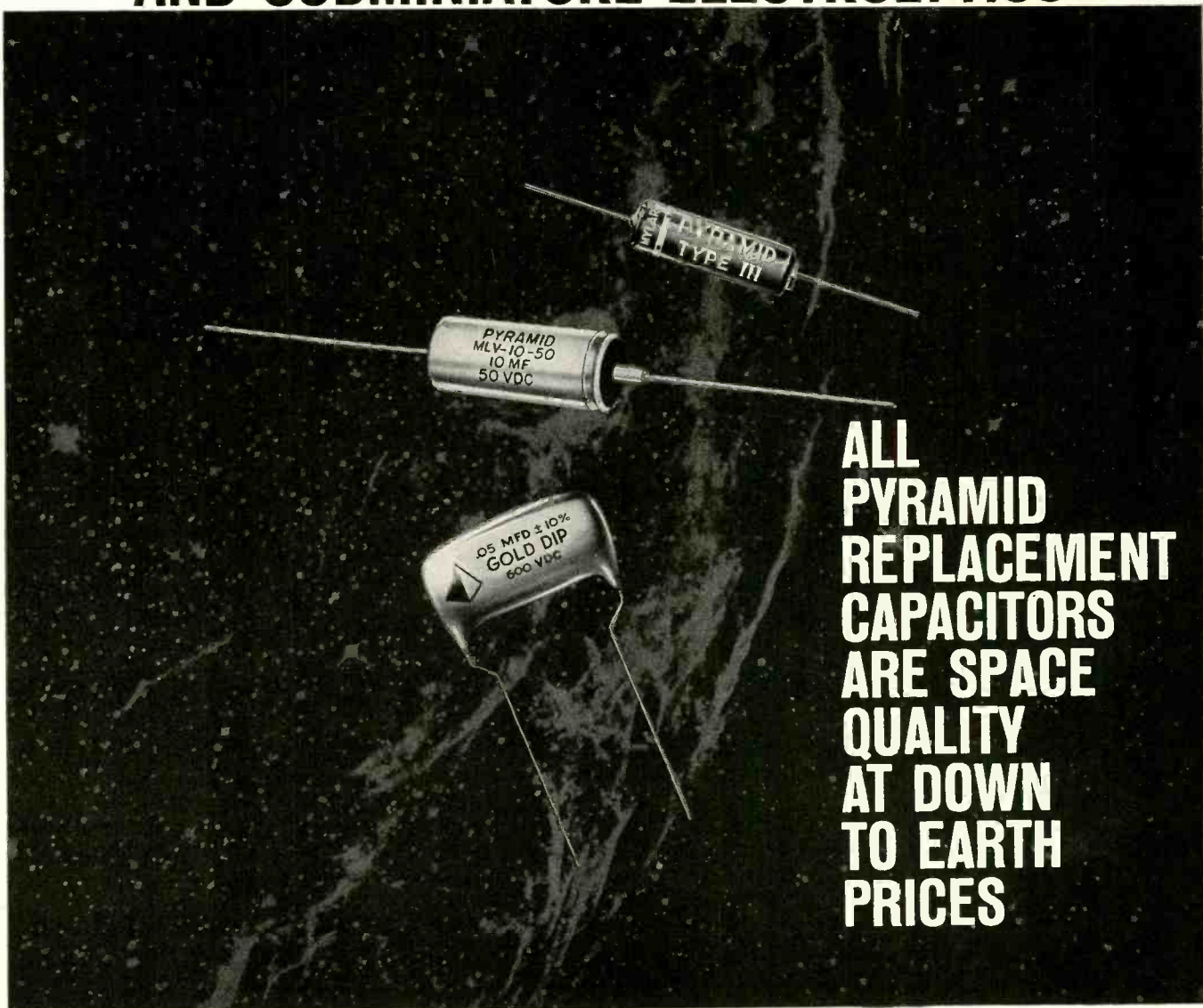

**ALL  
PYRAMID  
REPLACEMENT  
CAPACITORS  
ARE SPACE  
QUALITY  
AT DOWN  
TO EARTH  
PRICES**

**Pyramid makes the capacitors you want for replacement. Every type of Pyramid capacitor is manufactured under the most rigid standards to insure their high reliability and long life. You can depend on them.**

## **MOLDED MYLAR**

Type 111 "Gold Standard" Molded Mylar Capacitors are now available in greatly reduced sizes. They have a noninductive polyester film extended foil section, and are molded in a nonflammable thermosetting plastic case. These capacitors have very high insulation resistance, are impervious to moisture and are extremely rugged. Operating temperature range:  $-55^{\circ}\text{C}$  to  $+100^{\circ}\text{C}$ .

## **SUBMINIATURE ELECTROLYTICS**

MLV Miniature Electrolytic Capacitors are ideally suited for transistorized radio receivers, hearing aids, portable TV sets, and miniaturized circuit requirements. These capacitors are noted for low leakage and a long shelf and operating life. They are designed for  $85^{\circ}\text{C}$  operation.

## **DIPPED MYLAR**

Type 151 Gold-Dip Mylar capacitors are designed to be used for printed board circuitry as well as conventional applications. They are engineered for the highest reliability, are moisture resistant and have high insulation resistance.

Operating temperature range:  $-55^{\circ}\text{C}$  to  $+110^{\circ}\text{C}$ . Look for them on Pyramid's new Whirl-o-mat, five to a package, in Clear-Vu paks.

#DU POINT TM

**PYRAMID ELECTRIC  
COMPANY**

DARLINGTON, SOUTH CAROLINA

Canada: Wm. Cohen, Limited, 3900 Tanguay Street, Montreal  
Export: Morhan Exporting Co., 485 Broadway, New York 13, N.Y.





The Beautiful  
*Schober*  
CONSOLETTTE  
—only small organ with two full 61-note keyboards and 22 stops. Requires only 2'x3'2" floor space! Commercial value approximately \$1600 or more.

# BUILD THIS SUPERB *Schober* ORGAN FROM SIMPLE KITS and save over 50%

Give Your Family A Lifetime of Musical Joy With A Magnificent Schober Electronic Organ!

Now you can build the brilliant, full-range Schober CONSOLETTTE or the larger CONCERT MODEL with simple hand tools! No skills are needed; no wood-working necessary. Just assemble clearly marked electronic parts guided by step-by-step instructions. You build from kits, as fast or as slowly as you please . . . at home, in your spare time — with a small table serving as your entire work shop.

### Pay As You Build!

Start building your organ at once, investing just \$18.94! The superb instrument you assemble is as fine, and technically perfect, as a commercial organ . . . yet you save over 50% on quality electronic parts, high-priced labor, usual store mark-up!

### Free Booklet

Send for 16-page booklet in full color describing Schober organs you may build for home, church or school — plus articles on how easy it is to build your own organ and how pleasant it is to learn to play. Also available is 10" LP demonstration record (price \$2.00 — refundable on first order). Send for literature. No obligation and no salesman will call.

THE GREAT CONCERT MODEL meets specifications of American Guild of Organists

Mail This Coupon For FREE Schober Literature And Hi-Fi Demonstration Record TODAY!

The Schober Organ Corp., Dept. RE-12  
43 West 61st St., New York 23, N.Y.

Please send me the FITEE Color Booklet and other literature on the Schober organs.

Please send me the 10" hi-fi Schober demonstration record. I enclose \$2.00 (refundable on receipt of my first kit order).

Name.....

Address.....

City..... Zone..... State.....

# TV Service CLINIC

conducted by  
**JACK DARR**  
SERVICE EDITOR

This is your column in the magazine: the service is absolutely free; there is no charge for answering your questions, and your name and address will be kept confidential if you so wish. The main purpose is to help everyone working in electronics with their unusual problems. Send in your questions; each one gets an immediate personal answer. Later, the more interesting cases are published in the Clinic columns.

Due to the many peculiarities found in commercial TV circuits, you might find a different answer to a question than the one we give, even though the "conductor" of this column is himself a full-time professional TV technician. We would be interested to hear of such cases, as we feel that the more widespread the knowledge of such peculiarities, the better off we'll all be! So, if you have an unusual service job, or one which is giving you trouble from an obscure cause, send in a question on it; we'll answer it promptly and to the best of our ability.

**A**BOUT as puzzling a case as you'll find anywhere is the TV set which is "almost all right." It's performing pretty good, but you have that sneaky feeling that it just isn't doing all the things it ought to do!

A great deal of this "marginal performance" can be traced to components which are not completely defective, but which are just enough off value to affect the performance of the set. Not much off, perhaps only 10%, but enough to give a barely noticeable loss in the picture—just a wee bit too much snow, a little bit of distortion in the sound, picture not quite bright enough, and so on.

These are not "bad" parts. They're not shorted, for instance, but they definitely aren't up to what they should be. And, the worst part of it, they must be hunted out one at a time! It takes a lot of effort to dig them out, for they've got to be disconnected and tested individually.

Capacitors, for example, must be disconnected and checked on a good capacitor tester, not only for capacitance, but for very small values of leakage as well. If you own a unit that applies operating voltages to capacitors, you're lucky, for it is a great help in this kind of work. If you don't have such an instrument, here's one simple test that can pick up leaky capacitors. Connect one end of the capacitor to a source of dc voltage, say 200 volts. Connect a vtvm to the open end, and see how much dc voltage appears across the capacitor!

If the reading rises to a fairly high value, ground the probe end and see if the charge reappears. If it comes back

up pretty quickly, the capacitor is leaking and should not be used in sensitive circuits such as the very high resistance networks found in certain types of age systems, where it must work among 4- and 5-megohm resistors, etc. Video coupling capacitors, sync coupling capacitors, audio couplers and tuning capacitors across horizontal oscillator ringing coils are a few of the sensitive applications which demand absolutely perfect capacitors. Even a fraction of a volt leakage in most of these circuits can cause obscure troubles. You'll even find certain bypass applications where minute leakage is a headache. For example, in one color TV set, leakage in the screen bypass capacitor of the bandpass amplifier causes mysterious oscillations and beats on the screen. The reason for this is that the screen circuit happens to be a part of a tuned circuit in this application! Upsetting this causes trouble.

Resistors, too, come in for their share as troublemakers. For instance, if the plate load resistor in the output section of the horizontal multivibrator drifts off value, it will not upset the plate voltage to any measurable extent, but it will play hob with the time constant of that circuit! (The load resistor and coupling capacitor to the output stage form an R-C network.)

So, what have you here? The horizontal oscillator may stay on frequency, but it refuses to like it! Actually, it is trying to drift off frequency *all the time* and is restrained from doing so only by the action of the horizontal afc. This puts the afc circuit in the position of the man who is trying to lead a

mule; it is compelled to dig in its heels and keep a continuous pull on the balky circuit! Under these conditions, any disturbance, such as static, may allow the afc to break loose, and the set falls out of sync.

The large-value resistors used in popular agc circuits, such as those used with 6BU8's and similar tubes, are very important. Although many technicians don't realize this, these big resistors, often as large as 10 or 20 megohms, usually form part of a very critical voltage divider! The resulting voltages are used to determine the operating bias on the agc and sync-clipper tubes, which is usually fairly critical! So, if the resistors drift too far, away goes the bias, and we get sync troubles, poor horizontal or vertical hold action and a raft of other difficulties.

There are several ways to check these, aside from voltage measurements which are often misleading. Disconnect one end of each resistor and check it with your ohmmeter. If it reads within tolerance, apply heat with a soldering iron. If it holds its rating while good and hot, it is probably OK. Quite a bit of this trouble is caused by thermal drift. This kind of drift is also prevalent in PC boards, especially if the resistors have very short leads. When the board is dip-soldered, enough heat is often conducted up the short leads to affect the composition of the resistor, developing an incipient trouble where the leads enter the resistance element. When replacing a resistor in such cases, leave the leads at least 1/2 inch long, and use a heat sink when soldering.

### 21-inch 630

*I would like to convert an RCA 630 to a 21AMP4-A. What electrical changes are required?—S. W. F., Camden, N. J.*

A 21AMP4-A requires a 90° yoke, such as the Merit MDF-91. The flyback transformer must be changed to a unit such as the Merit HVO-55. The Stancor A-8150 vertical output transformer will provide full vertical deflection. The schematic for the RCA KCS-92 makes a convenient check for wiring connections.

### Bad horizontal phasing

*We have a Philco 49-1150 TV with phasing ghosts which we cannot remove by adjustments. The picture will lock in with no change in ghosts when the signal line from the damper plates to the horizontal afc is disconnected. We'd appreciate any suggestions.—B. J., E. S., St. Ann, Mo.*

The horizontal difficulties in the '49 Philco are probably caused by some trouble around the horizontal range trimmer capacitor or in the resistances in the voltage divider in the same circuit. Check them out carefully, especially the 100,000-ohm unit shunted across the trimmer (Fig. 1).

In this chassis and the '50 models which followed it, quite a bit of trouble was found in the 270- $\mu$ f; blocking

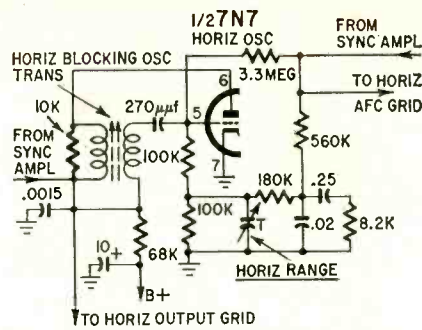

Fig. 1—Horizontal oscillator circuit in Philco 49-1150.

capacitor from the blocking oscillator transformer to pin 5 of the horizontal oscillator. Check for leakage.

### Sound bounce

*In a Canadian-built Motorola, similar to the US TS-531A, the vertical output is bouncing with the sound! When I turn the volume up, the picture bounces up and down.—L. D., Chilliwack, B. C.*

The most likely cause for this is some trouble in the audio cathode circuit. This is the source of the 145-volt line that feeds the vertical oscillator. There are two 200- $\mu$ f electrolytics in there, for filtering. One of them is probably defective. Check the 145-volt line with a scope for signs of audio signals. Try feeding a 400-cycle signal into the audio and hunting for it. If it's there, use more filter capacitance.

### No boost voltage

*There's flyback trouble in a Bendix model 2070U. The flyback has been replaced with a Stancor A-8130, with no results. The main trouble seems to be a lack of boost voltage. I've changed all the capacitors including the boost capacitor. Still I get only 300 volts at pin 3 of the 6W4. I shorted out the yoke, but still no change.—J. P. R., La Marque, Tex.*

The Stancor flyback you mention is listed as a replacement for this set. Fig. 2 shows the correct connections as given in the manual. However, from the symptoms, your trouble is not in the flyback but more likely in the yoke. Shorting out the yoke kills the boost voltage, as this voltage is derived from the flyback pulse from the yoke!

Check the yoke leads with a scope, by holding the probe tip near them but not touching. See if you can find the very high-voltage spike going into and coming out of the yoke, to the plate of the damper.

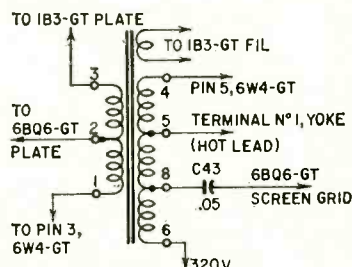

Fig. 2—Correct connections for Stancor A-8130 flyback as used in a Bendix 2070U TV.

Also, try substituting the horizontal section of a yoke with the same inductance. Disconnect the yoke and connect the substitute across the proper terminals on the flyback—5 and the damper plate.

If the yoke is defective, this will bring the boost voltage back. The original yoke is an 8.3-mh type. You can use anything from a 7- to 10-mh yoke for testing, although I would recommend an exact duplicate for replacement, if necessary.

Incidentally, did you check the series capacitor in the yoke return lead? It often develops leakage and will short out the boost voltage.

### Replacement yoke

*I have a TV console, made by Regal Electronic Corp., series 20, in the shop. I can't find any listing on this chassis and the yoke is burned. Can you tell me what yoke and flyback I need?—L. C. D., Charlotte, N. C.*

A Triad Y-21-1 is an exact replacement for this yoke. The flyback can be replaced by a Triad D-56. The yoke is a transformer type, with 10.3-mh horizontal inductance and 41.5 mh vertical inductance. The flyback is a transformer type, with a 1400-mh and 400-mh primary, with the secondary tapped at 12.48 and 0.16 mh.

### Picture has S-bend

*The set is a Philco 7H20 TV: It came in with a bad filter capacitor, which I replaced, and other troubles. Now, the picture has a slight S-bend in it, and it runs at the wrong horizontal oscillator frequency for about 30 seconds after it's turned on. If I short out the sync, the bend disappears. I've checked the afc diode and all tubes. The sync separator plate is about 10 volts high.—R. W., Saskatoon, Sask.*

You still have one more filter capacitor to go, somewhere! Pulling and bending like this is almost always caused by a lack of filter capacitance. The 10- $\mu$ f unit in the horizontal oscillator plate supply is a good candidate, also the 20- $\mu$ f unit a little farther along the same circuit. Check the B-plus supply lines with a scope. Usually, you'll find quite a bit of assorted ripple on them, as shown in Fig. 3. This upsets the horizontal oscillator control action and everything else in the vicinity! END

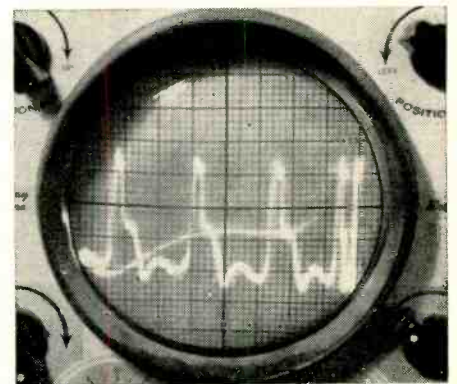
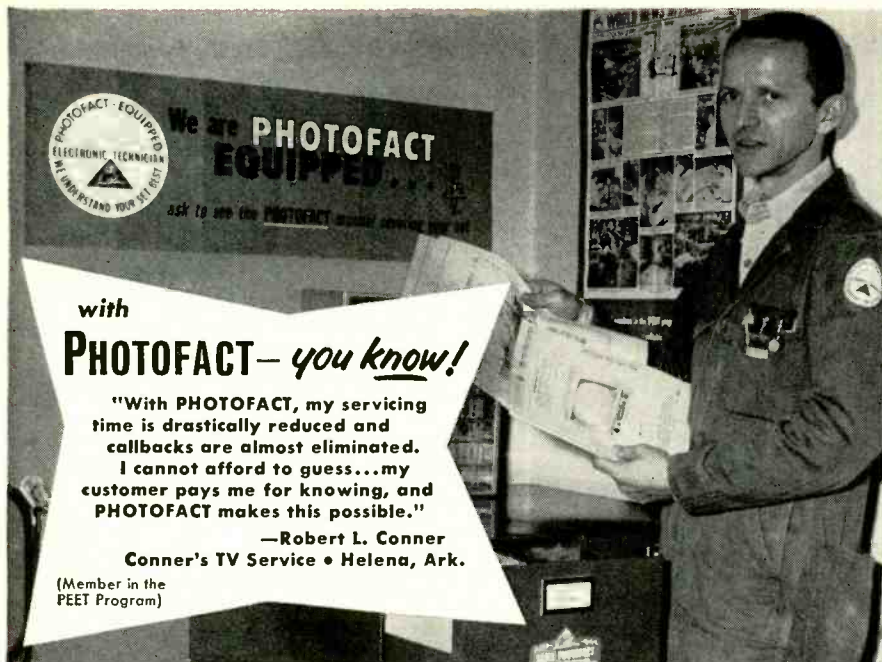

Fig. 3—High ripple, like this, can cause S bends in TV pictures. A bad electrolytic is usually at fault.



with  
**PHOTOFACT— you know!**

"With PHOTOFACT, my servicing time is drastically reduced and callbacks are almost eliminated. I cannot afford to guess...my customer pays me for knowing, and PHOTOFACT makes this possible."

—Robert L. Conner  
Conner's TV Service • Helena, Ark.

(Member in the  
PEET Program)

## Service Technicians! YOU EARN MORE... YOU RATE with the public when you own the PHOTOFACT® service data library!

You enjoy maximum earnings as the owner of a complete PHOTOFACT Service Data Library! It's inevitable, because no matter how expert you are, you can always *save more time on any job, get more jobs done daily*—EARN MORE, DAY IN AND DAY OUT...

What's more—as the owner of a complete PHOTOFACT Library, you know your customers' sets *best*. You can actually show each customer you have the PHOTOFACT Folder covering his very own set. Result: You command public respect and acceptance which paves the way to more business and earnings for you.

### HOW TO STAY AHEAD...

Yes, the truly successful Service Technicians are those who own the complete PHOTOFACT Library, who can meet and solve any repair problem—faster and more profitably. And these men *keep ahead* because they're on a Standing Order Subscription with their Distributors to receive all new PHOTOFACTS as they are released monthly. (They're eligible for the benefits of membership in PEET, too—see below!)

**ONLY \$10 DOWN** puts the complete PHOTOFACT Library in your shop—and you have up to 30 months to pay. See your Sams Distributor today, or write to Howard W. Sams

**NOW IS THE TIME TO JOIN**

**"PEET"**

### THE POWERFUL NEW PROGRAM FOR QUALIFIED TECHNICIANS

If you now own a PHOTOFACT Library or plan to own one, you can apply for membership in "PEET." It's the first industry program really designed to build powerful public acceptance for the Service Technician who qualifies. Builds enviable prestige and business for its members. Benefits cost you absolutely nothing if you qualify. Ask your Sams Distributor for the "PEET" details, or mail coupon today.

**HOWARD W. SAMS & CO., INC.**

1726 E. 38th St., Indianapolis 6, Ind.

- Send me full details on the new "PEET" Program.  
 Send full information on the Easy-Buy Plan and Free File Cabinet deal.  
 I'm interested in a Standing Order Subscription.  
 I'm a Service Technician  full-time;  part-time

My distributor is \_\_\_\_\_

Shop Name \_\_\_\_\_

Attn: \_\_\_\_\_

Address \_\_\_\_\_

City \_\_\_\_\_ Zone \_\_\_\_\_ State \_\_\_\_\_

TECHNICIANS'

NEWS

### PROBLEM OF LICENSING

*Kansas City, Mo.*—Judge Ben Terte issued a temporary injunction against the city, members of the Examining Board, the Mayor and the police, restraining them from enforcing the existing Kansas City TV Service License Law. The injunction also sought to have existing licenses suspended. This the judge did not grant.

As it now stands, firms that are licensed may advertise and display the license. No arrests may be made because the provisions of the ordinance do not make licensing mandatory.

This status is to stand until revoked by the courts. Trial date for the permanent injunction has not been set.

### WELCOME ABOARD

*Allentown, Pa.*—A new technician's association publication is out, and we are happy to add it to our thriving list of service association publications. Anyone else we don't know about yet?

**Lehigh Valley Electronics Association Newsletter**  
P. O. Box 731  
Allentown, Pa.

### WHO'S ON TOP

*Fort Worth, Tex.*—The six top officers of the Texas Electronics Associations are members of the executive council. There is also a board of directors made up of one director from each local, who represents the local at board meetings.

Members of these two groups are:

Executive council: Marvin F. Tappe, Julius Burke, G. M. Bettis, Thomas Boyd, Norris Brown and T. B. Drisdale.

Directors: Ray Burdette, Lindy Temple, Herb Kent, J. B. Penney, James Johnson, Louie Thrall, Don Chambers, Tom Boyd and Robert Greenlee.

### TV SERVICE PANEL

*Mobile, Ala.*—Thirty-three service companies and the Better Business Bureau have set up a TV Service Panel to help boost public confidence in local TV repair companies. The panel, made up of a service technician, a member of the BBB and a representative of the general public, will arbitrate unsettled complaints about TV repairs.

### TESA—CLEVELAND NOTES

*Cleveland, Ohio*—Hire only qualified personnel to repair sets; explain all charges to the customers; do not exceed cost estimates; present itemized bills for every job! These are the four main points of a code of ethics adopted by the Greater Cleveland Chapter of the Television & Electronics Service Association. The code is designed to improve the standing of the electronics technician in Cleveland.



The chapter has also elected its new officers. Edward Mato is president; Ray Kacprzak, vice president; Gus Mirsalis, recording secretary; Gene Kotrba, corresponding secretary; Harry Bertack, treasurer, and Levi Mosley, sergeant-at-arms.

### LICENSE BILL DIES

*Indianapolis, Ind.*—A proposed state bill for the licensing of radio and TV service technicians died in the State House of Representatives. The House adjourned without acting on the measure. The failure to put the bill through was caused by a general lack of interest among legislators to further licensing of industry, according to a spokesman for the sponsoring Indiana service technicians association.

### ELECTION IN FLORIDA

*Miami, Fla.*—New officers of TESA-Miami chapter are Daniel Prowler, president; Charles D. Pierce, first vice president; James P. Cresswell, Jr., second vice president; Samuel Kessler, recording secretary; Maxwell Reiser, corresponding secretary, and Charles W. Minter, treasurer.

The terms of all seven members of the board of directors ran out at the same time so this year there is a complete new slate. Elected for two-year terms were Austin Hearell, Joseph Merlin, Roger J. Mistleh and Robert Seymour. One-year terms went to George J. Clair, George Klele, Jr., and Don Powley.

### TESA-SPRINGFIELD MEETS

*Springfield, Ohio*—Bad checks and forgeries were the topics of a recent Television & Electronic Service Association meeting. The subject was presented by Sergeant Rader of the Springfield Police Div. Using actual case histories and exhibits, he showed how to spot and avoid bad checks—useful information for any businessman.

### NO PROBLEMS HERE

*New York, N.Y.*—A recent article on transistor radio servicing stirred up a bit of discussion among the readers of *Home Furnishings Daily*. The Associated Radio-Television Servicemen of New York (City) in reply pointed out that they found three major bugaboos in servicing these sets: lack of replacement parts, nonstandardization of transistors and parts, and lack of accurate technical information.

A reply from the Sampson Co. (they import Hitachi radios) affirmed that, in the case of one imported brand at least, these difficulties do not exist. They have, they say, a complete stock of all replacement parts for Hitachi radios, the sets use transistors with American type numbers and a complete service manual is available for every model Hitachi radio they distribute.

### Tip to Technicians:

They go on to state that "Upon receipt of a request for information by any service technician, under his letterhead, we immediately ship him a com-

plete set of service guides for all Hitachi radios at no charge." Write the Sampson Co., Electronics Div., 2244 South Western Ave., Chicago 8, Ill.

### SERVICE CLINIC EVENTS

Technicians got sneak previews on color and black-and-white TV service techniques at service clinics held in New Jersey and Delaware. The Radio Service Association of Trenton (N. J.) attended a color TV lecture and demonstration staged by Bob Lord of RCA. The clinic was sponsored by Jackson Distributors, a local parts dealer.

Also in New Jersey, 50 members of the Allied Electronics Technicians Association met at the Plaza Hotel in Camden to sit in on a Westinghouse service clinic. Members who attended report that it was the best ever held.

Over the border in Wilmington, Del., another Westinghouse clinic was held, this one for the Television Service Dealers Association. Problems in servicing the new sets and service hints on all Westinghouse receivers were presented and discussed.

### FRAUD CHARGES DISMISSED

Mr. Ellis Haddad of Jackson, Miss., operates a TV repair shop. A short while ago, one of his technicians worked on a rigged set—a deliberately blown fuse. The technician replaced four tubes and the fuse, and billed the customer \$17.95. Mr. Haddad was taken to court, charged with fraud. However, the charges against him were dismissed by the Judge on the grounds that "the master is not responsible for the act of a servant" and Mr. Haddad did not personally touch the TV set.

[The above may be justice, but if this editor ran into a TV receiver with a blown high-voltage fuse and a check with his milliammeter across the fuse showed normal operation he would feel obligated to replace, in addition to the fuse, the damper tube and the horizontal output tube. Other technicians might wish to replace the high-voltage rectifier and horizontal oscillator as well. Such steps will keep the technician from seeing the set again before the week is out for the same trouble. It is seldom indeed that a high-voltage fuse just gives up and a new fuse is the only replacement needed.—Editor]

END

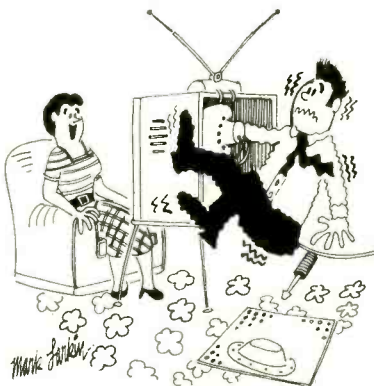

"Oh there's the picture now—it's 'You Asked for It!' "

## IMPORTANT NEW SAMS BOOKS

This Picture Book Diagnoses TV Tube Trouble

### TV Tube Symptoms & Troubles

by Bob Middleton



Most TV troubles are caused by faulty tubes. This new Sams book shows over 150 actual photos of defective TV screens, arranged by trouble symptom (picture tube displays of picture, sync, size and linearity, raster and sound troubles). Tells you what each section of a TV set is

supposed to do, what happens when it doesn't, and shows how to pinpoint troubles to specific sections and tubes. Special Tube Trouble Chart instantly relates troubles to specific tubes. No theory... just the practical photos and brief descriptions you need to locate most TV troubles in short order. 96 pages; 5 1/2 x 8 1/2". Only \$1.50

All You Need to Know to Align Radio & TV

### Radio & TV Alignment Handbook

by Warren J. Smith



If TV or radio alignment is hard for you, here's the book you'll want handy for constant reference. Tells you when alignment is necessary; shows what equipment you'll need, how to hook it up, how to follow alignment procedures in service literature, and how to evaluate results. Complete; covers UHF and VHF tuner alignment, adjustment and alignment of color TV, AM and FM radios, etc. Includes numerous photos, drawings and circuit diagrams. Helps you earn more through faster, better, customer-pleasing service work. 160 pages; 5 1/2 x 8 1/2". Only \$2.95

The Latest on Stereo—Hi-Fi

### Hi-Fi—Stereo Handbook

by William F. Boyce



This authoritative Sams book is fully revised to include the very last word on Stereo. Answers almost any question on Stereo and hi-fi anyone may want to ask. Covers sound fidelity and distortion, monophonic and stereophonic sound, stereo techniques, program source material, amplification and control, loudspeakers, enclosures, system design, selection and installation, multiplexing, etc. Profusely illustrated with diagrams and photos of equipment setups to guide you in detail along the way to better sound reproduction. 256 pages; 5 1/2 x 8 1/2". Only \$3.95

NEW! VOL. 8 SERVICING TRANSISTOR RADIOS! Just out—covers 51 important models produced in 1959-60. Complete PHOTOFACT® servicing data. 160 pages; 8 1/2 x 11". Only \$2.95

## HOWARD W. SAMS & CO., INC.

Order from your Sams Distributor today, or mail to Howard W. Sams & Co., Inc., Dept. F-21 1720 E. 38th St., Indianapolis 6, Ind.

Send me the following books:

- TV Tube Symptoms & Troubles (TVT-1)
- Radio & TV Alignment Handbook (RTH-1)
- Hi-Fi—Stereo Handbook (HFB-2)
- Servicing Transistor Radios (TSM-8)

\$.....enclosed.  Send Free Book List

Name \_\_\_\_\_

Address \_\_\_\_\_

City \_\_\_\_\_ Zone \_\_\_\_\_ State \_\_\_\_\_

IN CANADA: A. C. Simmonds & Sons, Ltd., Toronto 7 (outside U.S.A. priced slightly higher)

**Assemble your kit  
faster and better  
with the tool that  
makes soldering  
a cinch**



**Weller**

**DUAL HEAT SOLDERING GUN KIT**

Strong, noise-free soldered connections are the most important and time consuming operation in kit building. That's why a Weller Dual Heat Gun is a *must*. Instant heat saves time. Spotlight illuminates your work. 2 trigger positions give 2 soldering temperatures — low 90-watt heat for soldering near heat-sensitive components — high 125-watt heat for making chassis connections. Long life iron-plated copper tip provides superior heat transfer. Weller is the original Soldering Gun—used by virtually all electronic servicemen. On sale at your Electronic Parts Distributor.



Send for this booklet today—only 15¢

Fully illustrated, it tells how to make soldered connections simply and securely. Send your request to Weller Electric Corp., 601 Stone's Crossing Rd., Easton, Pa.

**WELLER ELECTRIC CORP. EASTON, PA.**

**new  
PRODUCTS**



**REACTANCE COMPUTER SLIDE RULE** determines resonant frequency from inductance and capacitance or selects various inductances and capacitances for desired frequency. Computes

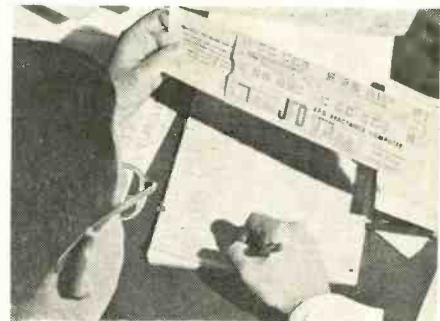

inductive and capacitive reactance as well as inductance and capacitance of resonant circuits from 1 to 1,000 mc. Plastic.—JFD Electronics Corp., 6101 16th Ave., Brooklyn 4, N. Y.

**FUSE POSTS, Model 3AG**, glow when fuse blows. Maximum current rating 20 amps. Over-

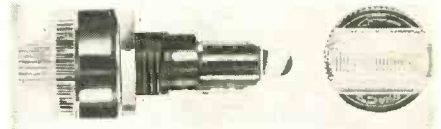

all length 2 3/8 in with fuse inserted. Mounting hole 3/8-in diameter flat at one side.—Littelfuse, Des Plaines, Ill.

**TRANSISTOR POWER CONVERTER, model MB-10**, in kit form. Converts power from either 6- or 12-volt storage batteries to regular house-

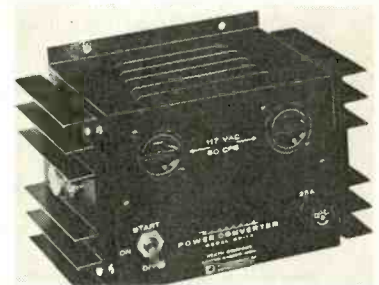

hold 117-volt 60-cycle ac. 2 ac receptacles. Power output 175 watts continuous, 240 watts maximum with 12 volts input; 120 watts at 6 volts input.—Heath Co., Benton Harbor, Mich.

**FLYBACK TRANSFORMERS, HO-321** replaces RCA parts 104876 (972942-1) and 106063 (972942-2); **HO-322** replaces RCA parts 104309

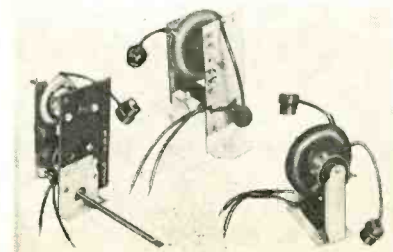

# WHAT YOU'LL NEED TO SERVICE THE ALL-NEW 1962 DELCO RADIOS

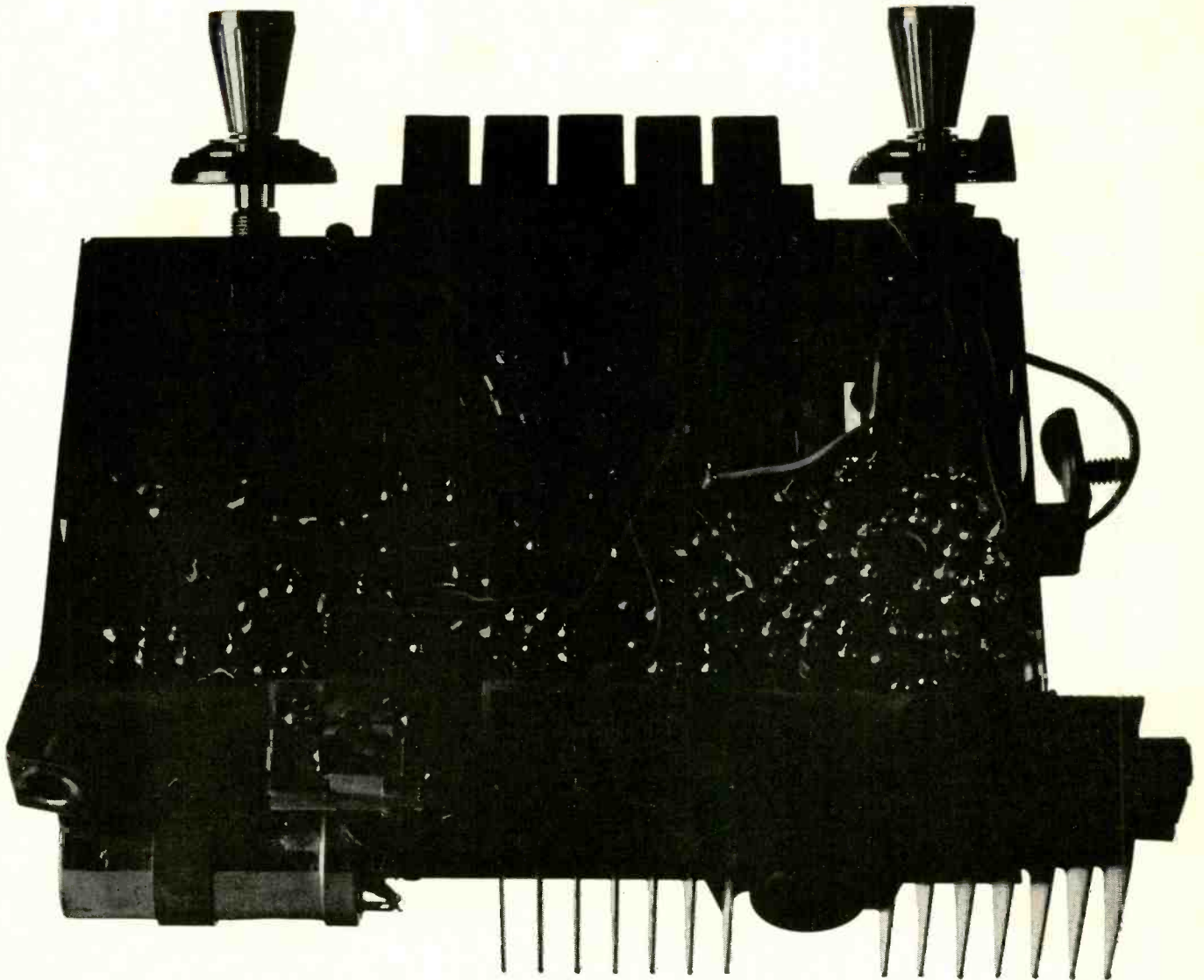

Very soon now you'll be able to see for yourself the big change we've made in the new model Delco Radios for General Motors 1962 cars. ■ To service them we have a special new parts package. It contains the 1962 parts—parts that are popular and fast moving. No "dogs"—we assure you! ■ Your Delco Electronic Parts Distributor will undoubtedly be swamped with orders for this new parts package (part #1962). So we can't urge you strongly enough to get your bid in early and have the new Delco parts on your shelf the day the new GM cars are on the street. ■ The service dealer who can take care of customers right away gets the most customers to take care of. We sure hope you'll be the one.

DIVISION OF GENERAL MOTORS - KOKOMO, INDIANA

**DELCO**  
DEPENDABILITY  
**RADIO**  
RELIABILITY

# BUILD 10-25 RADIO CIRCUITS AT HOME

with the New **PROGRESSIVE RADIO "EDU-KIT"®**

only \$15.95 up  
Reg. U.S. Pat. Off.

ALL Guaranteed to Work!

A Complete Home Radio Course



- BUILD**
- Receivers
  - Transmitters
  - Signal Tracer
  - Signal Injector
  - Code Oscillator
  - Sq. Wave Generator
  - Amplifier
  - No Knowledge of Radio Necessary
  - No Additional Parts or Tools Needed
  - Excellent Background for TV

## WHAT THE "EDU-KIT" OFFERS YOU

The "Edu-Kit" offers you an outstanding PRACTICAL HOME RADIO COURSE at a rock-bottom price. You will learn radio theory, construction and servicing. You will learn how to build radios, using regular schematics; how to solder and wire in a professional manner; how to service and trouble-shoot radios. You will learn how to work with punched metal chassis as well as the new Printed Circuit chassis. You will learn the principles of RF and AF amplifiers and oscillators, detectors, rectifiers, test equipment. You will learn and practice code, using the Progressive Code Oscillator. In brief, you will receive a basic education in Electronics and Radio, worth many times the small price you pay.

## PROGRESSIVE TEACHING METHOD

The Progressive Radio "Edu-Kit" is the foremost in educational radio kit in the world, and is universally accepted as the standard in the field of electronics training. The "Edu-Kit" uses the modern educational principle of "Learn by Doing." You begin by building a simple radio. Gradually, in a progressive manner, and at your own rate, you construct more advanced multi-tube radio circuits, learn more advanced theory and techniques, and do work like a professional radio technician. These circuits operate on your regular AC or DC house current.

## THE KIT FOR EVERYONE

You do not need the slightest background in radio or science. The "Edu-Kit" is used by young and old, schools and clubs, by Armed Forces Personnel and Veterans Administration for training and rehabilitation.

One of the most important aspects of the "Edu-Kit" is the Consultation Service which we provide. We welcome students to send us their problems, when related to any of the material covered in the "Edu-Kit" course, or encountered in other experiences in the field of electronics.

## THE "EDU-KIT" IS COMPLETE

You will receive all parts and instructions necessary to build several different radio and electronic circuits, each guaranteed to operate. Our kits contain tubes, tube sockets, variable electrolytic, mica, ceramic and paper dielectric condensers, resistors, tie strips, coils, hardware, tubing, punched metal chassis, Instruction Manuals, hook-up wire, solder, selenium rectifiers, volume controls, switches, etc. In addition, you receive Printed Circuit materials including Printed Circuit Chassis, special tube sockets, hardware and instructions. You also receive a useful set of tools: Pliers, cutters, an alignment tool, professional electric soldering iron, wrench set, and self-powered, dynamic Radio and Electronics Tester. The "Edu-Kit" also includes Code Instructions and the Progressive Code Oscillator. You will also receive lessons for servicing with the Progressive Signal Tracer and the Progressive Signal Injector, a High Fidelity Quiz, FCC Amateur License Training Book, and a Quiz Book.

## TROUBLE-SHOOTING LESSONS

You will learn to trouble-shoot and service radios, using the professional Signal Tracer, the unique Signal Injector and the dynamic Radio and Electronics Tester. Our Consultation Service will help you with any technical problems.

J. Stasajtis, 25 Poplar St., Waterbury, Conn., writes: "I have repaired several sets for my friends, and made money. The 'Edu-Kit' paid for itself. I was ready to spend \$240 for a course, but I found your ad and sent for your kit."

## FREE EXTRAS

- Set of Tools • Radio Book • Radio and Electronics Tester • Electric Soldering Iron • Pliers • Wrench • Alignment Tool • Tester Instruction Book • Hi-Fi Book • TV Book • Quiz Book • Membership in Radio-TV Club • Consultation Service • FCC Amateur License Training • Printed Circuitry • Certificate of Merit • Valuable Discount Card • Wrench Set

## Choose From These Popular "Edu-Kit" Models

- #10A: 10 Circuits \$15.95
- #15A: 15 Circuits \$19.95
- #16A: 16 Circuits (includes Printed Circuitry) \$22.95
- #20A: 20 Circuits (includes Printed Circuitry and 4 Advanced Circuits) \$26.95
- #25A: 25 Circuits (includes Printed Circuitry and 9 Advanced Circuits) \$30.95

**UNCONDITIONAL MONEY-BACK GUARANTEE**  
Please RUSH my Progressive Radio "Edu-Kit" to me. BE SURE TO INCLUDE all the FREE EXTRAS and BONUS RESISTOR and CONDENSER KITS WORTH \$7.00.

MODEL desired ..... Price .....

Send "Edu-Kit" postpaid. I enclose remittance in full.

Send "Edu-Kit" C.O.D. I will pay postage.

Send me FREE additional information describing "Edu-Kits."

Name .....  
Address .....

**Progressive "EDU-KITS" Inc.**

1186 Broadway, Dept. 177G Hewlett, N. Y.

(972401-3) and 106533 (973908-1); HO-336 replaces Motorola part 24C739283.—Chicago Standard Transformer Corp., 3501 W. Addison St., Chicago 18, Ill.

**SUBMINIATURE VARIABLE INDUCTORS**, for printed circuits or breadboards. Series 387: 10 units cover range of 1.5  $\mu$ h to 3 mh. Custom-



designed inductors with maximum inductance to 72 mh and MIL-grade units available.  $\frac{1}{2}$  x  $\frac{3}{8}$  in.—Wells Electronics, 1701 S. Main St., South Bend, Ind.

**PHONO JACK ADAPTER, No. 371.** Adapter (shown) mounts in panels up to 1 $\frac{1}{4}$ -in thick.

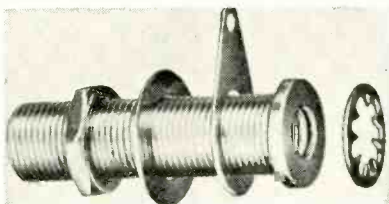

Mounting diagram; nut, lock and lug washers. —Switchcraft Inc., 5555 N. Elston Ave., Chicago 30, Ill.

**AUTO RADIO CONTROL REPLACEMENTS, 5 units.** Part Nos. PP-58 and PP-59 replace Philco original part No. 33-5580-21 and 33-5580-27 used in 1958 and 1959 Plymouths. Part Nos. DEM-59,

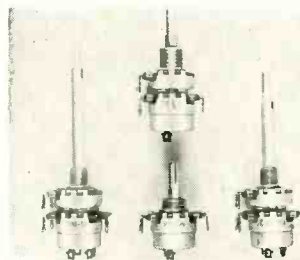

DOM-58 and DOM-59 replace Motorola original part Nos. 18K561733, 18K560417 and 18B561732 used in 1959 DeSotos, 1958 and 1959 Dodges.—Centralab, Div. of Globe-Union, 900 E. Keefe Ave., Milwaukee 1, Wis.

**SERVICE AID, model MT-1 Multi-Tracer**, combines signal injector, demodulator and signal

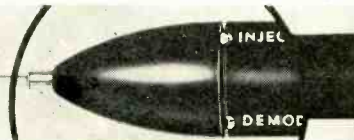

and voltage tracer. Rotating head with detent action for selection of required instrument position permits troubleshooting any electronic equipment.—Mercury Electronics Corp., 77 Searing Ave., Mineola, N. Y.

**SCREW DRIVER SET** converts into high-torque driver with side-arm T-handle. 2 interchangeable

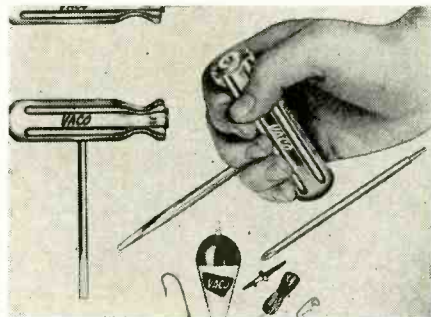

blades and free bonus fishing kit.—Vaco Products Co., 317 E. Ontario St., Chicago 11, Ill.

**LOW-NOISE PREAMP, model PA-LN**, for channels 2-13. Uses G-E 7077 ceramic triode, one 6DJ8 and five EF96's. Bandwidth  $\pm 0.75$  db 6 mc. Input 50 to 1,000  $\mu$ v. Gain 66 db minimum. Input

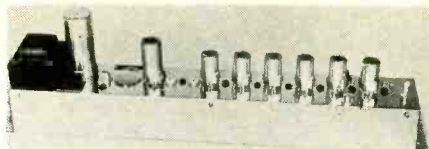

and output impedance 75 ohms. Supply 117 volts, 60 cycles, 30 watts.—Benco Television Associates Ltd., 27 Taber Rd., Rexdale, Ontario, Canada.

**TV TRANSLATOR TRANSMITTER.** Signals received directly with outside antenna from translator station which rebroadcasts signals received from originating station into shadowed areas. Installation either on cooperative basis or by tax district.—Industrial Television, 7270 Beverly Blvd., Los Angeles 36, Calif.

**COMMUNICATION TOWER**, measures 170 ft with addition of 3 heavy-duty 20-ft sections to

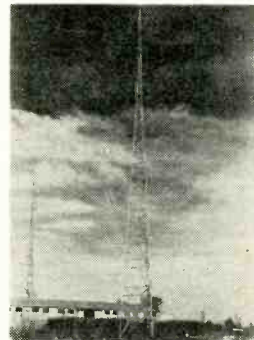

basic, self-supporting design.—Rohn Manufacturing Co., Box 200, Peoria, Ill.

**RECEIVER KIT, R-55.** Coverage from 530 kc to 36 mc in 4 bands, plus special range from 47 to 54 mc for tuning 6-meter amateur band.



Complete with metal cabinet, tubes, all parts, wire and solder.—Allied Radio Corp., 100 N. Western Ave., Chicago 80, Ill.

**FM TUNER, model 314.** Usable sensitivity 2.5  $\mu$ v by IHFM standards. Silverplated front end for minimum circuit losses on weakest signals. Copper-bonded to aluminum chassis for high signal-to-noise ratio. Multiplex output for multiplex-type stereo and multiplex-controlled com-

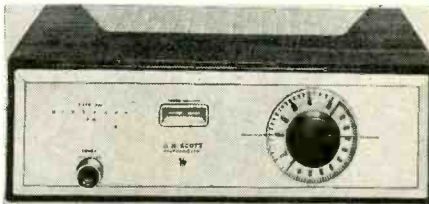

mercial installations. 15 $\frac{1}{2}$  x 5 $\frac{1}{4}$  x 13 $\frac{1}{4}$  in.—H. H. Scott Inc., Dept. P, 111 Powdermill Rd., Maynard, Mass.

**FM TUNER, model KN-111.** 2-stage, grounded-grid rf amplifier and ratio detector. Sensitivity 4  $\mu$ v for 20 db of quieting. Audio output ap-



proximately 0.55 volt. 2 $\frac{1}{2}$  x 9 $\frac{3}{4}$  x 7 $\frac{1}{2}$  in.—Allied Radio Corp., 100 N. Western Ave., Chicago 80, Ill.

**FM/AM 50-WATT STEREO RECEIVER, model S-7000.** 19 front-panel controls and switches; 9 inputs. Continuous power output 24 watts per channel. Hum and noise 80 db below 24 watts (radio) and -80 db (phono). Frequency re-

# DX-16 Super Deluxe TV KIT

70° or 90° — operating all 17", 21", 24" and 27" PICTURE TUBES

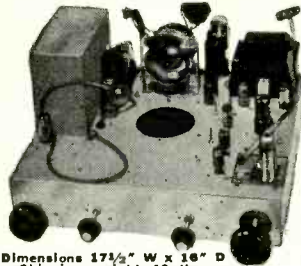

Dimensions 17 1/2" W x 18" D  
Shipping weight 40 lbs.

- ★ Produces a 16-Tube Chassis with 30-Tube performance.
- ★ Latest Intercarrier Circuitry and Multi-section Tubes.
- ★ Standard Neutrode Tuner for Selectivity & Fine Definition.
- ★ All Video and I.F. Coils factory pre-aligned and tuned.
- ★ Large 250ma Power Transformer for dependable service.
- ★ 12" Speaker or Twin-cone 6" x 9" Speaker.

Includes **LIFE-SIZE** step-by-step Building Instructions  
Most Up-To-Date and Practical Course in Television

**COMPLETE KIT**  
with SET of WESTINGHOUSE TUBES \$93.49

4-6CB6, 6U8, 8T8, 6C4, 12BH7, 6SN7, 6BD6, 8W4, 6K6, 1X2B, 5U4, 6BN4, 6GC8, incl. in the Tuner (less CRT)

Also sold on **EASY-PAYMENT-PLAN** Buy LIFE-SIZE Instructions—\$2.49—and buy Parts as you build.

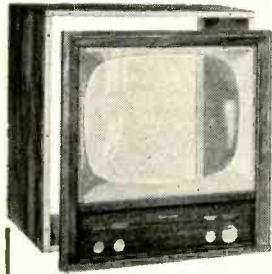

23" TV Cabinet Kit . . \$28.47    24" or 27" TV Cabinet Kit . . \$38.47    24" or 27" Front Panel Assembly . . \$24.97

## BUILD YOUR OWN CABINET FOR TV CHASSIS

Comparable to the type that Top Mfrs. use on high priced TV sets.

CABINET KIT with 90% of the job done, includes—  
FRONT SECTION in Solid Mahogany, Walnut or Blond Korina. TOP, SIDES, BACK, MASK, SAFETY GLASS, ETC.

And EASY-TO-FOLLOW ASSEMBLY INSTRUCTIONS  
Front, Top and Sides supplied in a beautiful Plano Finish • Knob panel undrilled • For matching Mask specify type or number of CRT used. Same price—Mahogany, Walnut or Blond. (Shipping weight 36 lbs.)

**21" CABINET KIT** 26" H, 25" W, 22" D \$26.97

## TECH-MASTER for 1961 ★ "GOLD MEDAL" #2430-B

LATEST #630 CIRCUITRY WORLD'S MOST POWERFUL TV CHASSIS  
COMPLETE ready to play — Including Tubes, 12" Speaker, Knobs, Etc. (less CRT)  
90° TV Chassis \$175.85    110° TV Chassis \$182.60    Brochure on request

### TUBULAR CONDENSERS—85°C TOP QUALITY—Equally as good for Radio or TV work

.0047-400v, .01-400v, .02-400v, .047-400v, .001-600v, .0047-600v, .01-600v, .02-600v, .03-600v 5¢ ea.  
.1-400v, .25-400v, .47-400v, .047-600v, .1-600v, .25-600v, .001-1000v, .0047-1000v, .01-1000v, 8¢ ea.  
.039-1000v, .047-1000v, .1-1000v, .007-1600v, .03-1600v, .05-1600v, .005-3000v, .001-6000v, 14¢ ea.

### ELECTROLYTIC CONDENSERS—85°C 1-50v, 1-150v, 2-450v, 25-50v, 8-150v 19¢ ea.

20/20-150v, 50/30-150v, 40-150v, 10-450v, 20-450v, 30-450v, 40-450v, 60-450v, 80-450v . . . . .34¢ ea.

### CARBON RESISTORS—Regular factory stock in Stackpole, Speer, etc.

1/2 WATT 10% 10, 20, 39, 47, 68, 100, 120, 150, 270, 330, 390, 470, 560, 680, 820, 1kΩ . . . . .2¢ ea.  
1/2 WATT 10% 1800k, 2700, 3300, 3900, 4700, 5600, 6800, 8200, 10k, 15k, 18k, 22k, 27kΩ . . . . .2¢ ea.  
1/2 WATT 10% 33k, 39k, 47k, 56k, 68k, 82k, 100k, 120k, 150k, 180k, 220k, 270k, 330kΩ . . . . .2¢ ea.  
1/2 WATT 10% 390k, 470k, 560k, 680k, 820k, Ω 1, 1.2, 1.5, 2.2, 6.8, 10, 15 MEGΩ . . . . .2¢ ea.  
1 WATT 10% 3.3, 10, 39, 100, 120, 150, 330, 470, 560, 680, 820, 1k, 1800, 2700, 4700Ω . . . . .3¢ ea.  
1 WATT 10% 6800, 10k, 15k, 18k, 22k, 27k, 33k, 39k, 47k, 68k, 82k, 100k, 150k, 470k, 680kΩ . . . . .3¢ ea.  
2 WATT 10% 18, 22, 82, 100, 180, 2200, 3900, 4700, 6800, 8200, 18k, 22k, 100k, 470kΩ . . . . .4¢ ea.

### WIREWOUND RESISTORS 5-5w, 16-10w, 20-10w, 47-5w, 70-10w, 100-5w, 140-5w. 9¢ ea.

220-5w, 280-10w, 390-5w, 470-5w, 500-10w, 680-10w, 820-5w, 1K-10w, 1500-5w, 2K-10w . . . . .9¢ ea.  
2500-5w, 3K-10w, 4700-5w, 5K-10w, 6K-10w, 7K-10w, 8200-5w, 10K-5w, 15K-5w, 20K-10w . . . . .9¢ ea.

### CERAMIC CONDENSERS 1, 2, 3, 5, 6, 10, 22, 25, 47, 50, 51, 56, 82, 100, 120, 150 mmf . . . . .3¢ ea.

CERAMIC CONDENSERS 220, 250, 270, 330, 470, 1k, 1200, 1500, 2k, 5k, 6800, 10k mmf . . . . .3¢ ea.

### MICA CONDENSERS 5, 25, 50, 60, 68, 75, 100, 120, 150, 220, 270, 330, 470, 510 mmf . . . . .3¢ ea.

MICA CONDENSERS 560, 680, 820, 1k, 1500, 2k, 2500, 3300, 4700, 6k, 6800, 8k, 10k mmf 3¢ ea.

## 10-TUBES #1U4..\$1

- 10 - ELECTROLYTIC COND. 100-25/50v. . . . \$1
- 1 - 5" PM SPEAKER alnico #3 magnet . . . . \$1
- 1 - 4" PM SPEAKER alnico #3 magnet . . . . \$1
- 1 - 3" PM SPEAKER alnico #3 magnet . . . . \$1
- 1 - 3 1/2" TWEETER SPEAKER for HI-FI . . . . \$1
- 5 - SETS SPEAKER PLUGS wired . . . . . \$1
- 3 - AUDIO OUTPUT TRANS. 50L6 type. . . . \$1
- 2 - AUDIO OUTPUT TRANS. 50L6 push-pull. . \$1
- 3 - AUDIO OUTPUT TRANS. 6K6 or 6V6 type. \$1
- 3 - I.F. COIL TRANSFORMERS 456 kc . . . . \$1
- 3 - I.F. COIL TRANSFORMERS 10.7 mc. FM . \$1
- 3 - I.F. COIL TRANSFORMERS 282 kc (auto). \$1
- 40 - ASST. PRECISION RESISTORS best sizes . \$1
- 25 - SELENIUM RECTIFIERS 65ma list \$1.50 ea. \$1
- 4 - SELENIUM RECTIFIERS 75ma . . . . . \$1
- 2 - SELENIUM RECTIFIERS 300ma . . . . . \$1
- 2 - SELENIUM RECTIFIERS 1-500ma 1-85 ma. \$1
- 1 - TV RATIO DETECTOR COIL 4.5mc . . . . \$1
- 1 - TV RATIO DETECTOR COIL 10.7mc . . . . \$1
- 1 - TV SOUND I.F. COIL 4.5mc . . . . . \$1
- 3 - HV RECTIFIER SOCKETS 1B3 mounted . . . \$1
- 3 - HV RECTIFIER SOCKETS 1X2 mounted . . . \$1

- \$15 - "JACKPOT" TELEVISION PARTS . . . \$1
- 10 - ELECTROLYTIC CONDENSERS 1200 mfd-25v. \$1
- 50 - ASSORTED MOLDED COND. short leads. . \$1
- 2 - SILICON RECTIFIERS 500ma . . . . . \$1
- 1 - SILICON RECTIFIER 750ma . . . . . \$1
- 1 - LB. SPOOL ROSIN CORE SOLDER . . . . \$1
- 4 - 50' SPOOLS HOOK-UP WIRE 4 colors . . \$1
- 10 - 6' ELECTRIC LINE CORDS with plugs . \$1
- 50' - 2-CONDUCTOR ZIP CORD No. 18 . . . \$1
- 5 - TV CHEATER CORDS with both plugs . \$1
- 5 - TV CRT. SOCKETS with 18" leads . . . \$1
- 5 - HI-VOLT. ANODE LEADS with 18" leads . \$1
- 50 - STRIPS ASST. SPAGHETTI best sizes . \$1
- 100 - ASST. RUBBER GROMMETS best sizes \$1
- 100' - TWIN LEAD-IN WIRE 300Ω heavy duty \$1
- 50' - FLAT 4-CONDUCT. WIRE many purposes \$1
- 25' - INSULATED SHIELDED WIRE . . . . \$1
- 32' - TEST PROD WIRE deluxe (red or black) \$1
- 1 - \$7 INDOOR TV ANTENNA hi-gain 3 section \$1
- 20 - ASST. TV KNOBS, ESCUTCHEONS, Etc. \$1
- 1 - RCA 70' FLYBACK TRANS. #75240. . . \$1
- 1 - TV VERT. OUTPUT TRANS. 10 to 1 ratio. \$1
- 15 - ASST. TV COILS sync. peaking, width, etc. \$1
- 15 - ASST. STANDARD TUNER UHF STRIPS. \$1
- 6 - ASST. STANDARD TUNER VHF STRIPS. \$1

## "ONE DOLLAR" Buys

As much as \$15 worth — Everything Brand New and sold to you with a money back guarantee.

**DEDUCT 10% ON ANY ORDER OF \$10 OR OVER**

(ON DOLLAR BUYS)

Plus a FREE SURPRISE PACKAGE

- 10 - DIODE CRYSTALS 1N34A . . . . . \$1
- 2 - MICROPHONES 200 ohm, hi-gain. . . . \$1
- 300 - 1/2 WATT RESISTORS short leads . . \$1
- 3 - TODD 60° DEFLECTION YOKES. . . . . \$1
- 80' - MINIATURE ZIP CORD 2 conductor. . \$1
- 20 - TUBULAR CONDS. .47-100v (tests 600 v). \$1
- 20 - 50K VOLUME CONTROLS less switch. . \$1
- 100 - ASST. 1/2 WATT RESISTORS some 50¢ \$1
- 70 - ASSORTED 1 WATT RESISTORS " " \$1
- 35 - ASSORTED 2 WATT RESISTORS " " \$1
- 50 - ASST. TUBULAR CONDENSERS . . . . \$1
- 50 - ASSORTED FUSES popular sizes . . . \$1
- 75 - 220K 1/2 WATT RESISTORS 10% . . . \$1
- 75 - 470K 1/2 WATT RESISTORS . . . . . \$1
- 10 - WIREWOUND RESISTORS 70 ohm 10w. . \$1
- 10 - WIREWOUND RESISTORS 650 ohm 10w. \$1
- 10 - WIREWOUND RESISTORS 1000 ohm 10w \$1
- 10 - ASST. WIRE'ND RES. 5, 10, 20 watt . \$1
- 5 - DIODE CRYSTALS 2-IN21 2-IN221-IN64 . \$1
- 4 - DIODE CRYSTALS 1-IN60 2-IN64 1-IN60 . \$1
- 4 - DIODE CRYSTALS 1N64 . . . . . \$1
- 4 - DIODE CRYSTALS 1N80 . . . . . \$1
- 100 - ASST. CERAMIC CONDENSERS. . . . \$1
- 35 - ASST. DISC CERAMICS best numbers. . \$1
- 50 - ASST. MICA CONDENSERS some in 5% . \$1
- 6 - ASST. SLIDE SWITCHES asst. dpdt, etc. . \$1
- 4 - BAKELITE KNIFE SWITCHES. . . . . \$1
- 3 - ASST. TOGGLE SWITCHES spst, dpdt, etc. \$1
- 15 - ASST. ROTARY SWITCHES \$15 worth. . \$1
- 100' - FINEST NYLON DIAL CORD best size . \$1
- 200 - SELF TAPPING SCREWS #8 x 1/2" . . \$1
- 35 - ASST. RADIO KNOBS screw and push-on \$1
- 100 - ASSORTED KNOB SET-SCREWS . . . \$1
- 25 - ASSORTED CLOCK RADIO KNOBS . . \$1
- 600 - ASST. H'DWARE screws, nuts, rivets, etc. \$1
- 35 - ASST. SOCKETS octal, novel and miniature \$1
- 25 - ASST. PRINTED CIRCUIT SOCKETS . . \$1
- 10 - ASST. VOLUME CONTROLS less switch. . \$1
- 5 - ASST. VOLUME CONTROLS with switch. \$1
- 20 - ASST. PILOT LIGHTS popular types. . \$1
- 10 - PILOT LIGHT SKTS. bayonet type, wired. \$1
- 50 - ASST. TERMINAL STRIPS 1, 2, 3, 4 lug. \$1
- 10 - ASST. RADIO ELECTRO. CONDENSERS. \$1
- 5 - ASST. TV ELECTROLYTIC CONDENSERS. \$1
- 25 - ASST. MICA TRIMMER CONDENSERS. \$1
- 15 - TUBULAR CONDENSERS .47-400v . . . \$1
- 15 - TUBULAR CONDENSERS .25-600v . . . \$1
- 15 - TUBULAR CONDENSERS .047-600v . . \$1
- 2 - ELECTROLYTIC COND. 40/40-450v . . \$1
- 3 - ELECTROLYTIC COND. 50/30-150v . . . \$1
- 25 - ASST. PEAKING COILS popular types . \$1
- 35 - DISC. CERAMIC CONDENSERS 5000mmf . \$1
- 25 - ASST. RADIO DIAL POINTERS . . . . \$1
- 8 - ASST. LUCITE CASES handy for parts. . \$1
- 100 - MICA CONDENSERS 820 mmf-500v . \$1
- 3 - ASST. SIZES RADIO CHASSIS PANS. . . \$1
- 3 - VARIABLE CONDENSERS super 420/162mfd. \$1
- 12 - RADIO OSCILLATOR COILS 456 kc. . . \$1
- 4 - OVAL LOOP ANTENNAS asst' hi-gain types \$1
- 3 - LOOPSTCK ANT. now ferrite adjustable . \$1
- 3 - 1/2 MEG VOLUME CONTROLS with switch. \$1
- 10 - 750K VOLUME CONTROLS less switch. . \$1
- 5 - ASST. 4 WATT WIREWOUND CONTROLS \$1
- 5 - 1 or 2 MEG VOLUME CONTROLS less switch. \$1
- 5 - 1 or 2 MEG VOLUME CONTROLS \$1/switch. \$1
- 10 - SURE GRIP ALLIGATOR CLIPS . . . . \$1
- 1 - GOLD GRILLE CLOTH 14"x14" or 12"x18". \$1
- 10 - SETS PHONO PLUGS and PIN JACKS. . \$1
- 2 - \$2.50 SAPPHIRE NEEDLES 4000 playings \$1
- 35 - MICA COND. 20-50 mmf & 15-68 mmf . . \$1
- 35 - MICA COND. 20-180 mmf & 15-270 mmf . \$1
- 35 - MICA COND. 20-470 mmf & 15-680 mmf . \$1
- 35 - MICA COND. 20-820 mmf & 15-1000 mmf . \$1
- 35 - MICA COND. 20-2200 mmf & 15-2400 mmf . \$1
- 35 - MICA COND. 20-6800 mmf & 15-10000 mmf . \$1
- 35 - CERAMIC COND. 20-5 mmf & 15-10 mmf . \$1
- 35 - CERAMIC COND. 20-25 mmf & 15-47 mmf . \$1
- 35 - CERAMIC COND. 20-56 mmf & 15-82 mmf . \$1
- 35 - CERAMIC COND. 20-100 mmf & 15-150 mmf . \$1
- 35 - CERAMIC COND. 20-270 mmf & 15-470 mmf . \$1
- 35 - CERAMIC COND. 20-1000 mmf & 15-1500 mm \$1
- 35 - CERAMIC COND. 20-2000 mmf & 15-5000 mmf \$1
- 4 - KENRAD TUBES 65H7 . . . . . \$1
- 2 - TOP NAME 125K7 TUBES . . . . . \$1
- 2 - TOP BRAND TUBES 35W4 . . . . . \$1
- TOP NAME TUBES 024, 1B3, 1X2B, 5U4, 6AC7, 6AX4, 6CB6, 6J6, 6K6, 6U8, 6V6, 6SN7, 6X8, 12AU7, 12AX7, 50L6 . . . . . Each \$1
- 3 - TV ALIGNMENT TOOLS assortment #1. . . \$1
- 3 - TV ALIGNMENT TOOLS assortment #2. . . \$1
- 3 - TV ALIGNMENT TOOLS assortment #3. . . \$1
- 3 - TV ALIGNMENT TOOLS assortment #4. . . \$1
- 3 - TV ALIGNMENT TOOLS assortment #5. . . \$1

EACH ALIGNMENT TOOL is different and valued at over \$1  
HANDY WAY TO ORDER—Simply tear out advertisement and pencil mark items wanted (X in square is sufficient); enclose with money order or check. You will receive a new copy of this ad for re-orders.  
ON SMALL ORDERS—include stamps for postage, excess will be refunded. Larger orders shipped express collect.

**BROOKS RADIO & TV CORP., 84 Vesey St., Dept. A, New York 7, N. Y.** TELEPHONE CORLAND 7-2359

**"TAB" Tubes Factory Tested, Boxed**  
Six Months Guarantee! No Rejects!  
**NEW & Used Gov't & Mfgs. Surplus!**

Orders \$10 or more, Receiving types only ppd, 48 states

0A2	.80	6B16	.69	12AT6	.59	18S1	1.00
0B2	.65	6BK7	.99	12AT7	.84	117Z6	1.10
0C3	.69	6BL7	1.25	12AU6	.69	4-65A	16.00
0D3	.39	6BW6	.69	12A7	.69	6X4	2.81
024	.59	6BQ6	1.19	12AX7	.79	3D23	3.85
1A7	.89	6BZ7	1.25	12BA6	.65	717A	5/81
1B3	.78	6C4	.43	12BA7	.99	4-125	29.00
1R5	.78	6C5	.69	12BE6	.59	1-250	3.00
1S4	.78	6CB6	.80	12BE6	.59	4P27	7.00
1T4	.78	6CD6	1.49	12BE6	.59	4P27	29.50

1U4	3/\$11	6H6	3/\$11	12BH7	.99	4X150G	\$15
1U5	.73	6J5	.52	12BY7	.98	4X250	35.00
1K2A	1.99	6J6	.44	12BY7	.98	4X500	38.00
3Q4	.68	6K6	.59	12CUG	1.45	58P1	8.00
3Q5	.86	6K6	1.65	12SA7	.94	58P4	7.50
3S4	.88	6L6	1.19	12SQ7	.89	35T	4.00
3V4	1.83	6S4	.59	12SH7	.59	100T	7.00
5R4	.98	6S8	.99	12SJ7	.75	316A	5/81
5U4	.75	6SA7	.69	12SK7	.94	388A	3/81
5V4	.80	6SB7	1.19	12SQ7	.84	415B	4.00

Wanted Surplus Electronics from schools & U.S. Gov't

5V3	.59	6SC7	.80	19BG6	2.15	450T	42.00
6A84	.55	6SQ7	.79	19T	1.16	80T	1.00
6AC7	.70	6SH7	.69	25B6	1.39	809	3.00
6AG7	.89	6SJ7	.99	25L6	.69	811	4.40
6AH6	.89	6SK7	.72	25W4	.77	812	3.00
6AK5	.89	6SL7	.89	25Z5	.69	813	3.00
6AL5	2/\$11	6SN7	2/\$11	25Z6	.75	814	3.45
6AG5	.63	6SQ7	.74	EL34	3.49	815	2.75
6AS7	3.00	6SR7	.79	K766	3.29	824	2.00
6AT6	.49	6T8	.98	35L6	.69	829B	8.00

Wanted 811, 818, 819 and 504 TL tubes! Top \$\$\$ Paid

6AU4	1.10	6U8	.98	35W4	.49	832A	7.00
6AU5	1.19	6VGT	.79	19T	1.16	80T	3.50
6AU6	.69	6W4	.79	35Z5	.63	1625	2/81
6AX4	.79	6W6	.89	50A5	.69	6146	4.00
6BA6	1.39	6X4	2/\$11	6X4	.69	879	9.98
6BA7	1.00	6X5	.49	50C5	.69	5881	2.70
6BD6	.89	6Y6	.97	50L6	.69	6550	3.00
6BE6	.59	7M7	.89	K766	3.29	824	1.00
6BE6	1.50	12AL5	.55	75	.89	5894	12.00
6BH6	.72	12AQ5	.75	80	.59	7193	10/81

TUBES WANTED! WE BUY! SELL & TRADE!

**NEW SILICON 750MA\* DIODES TOP HATS**

GENERAL PURPOSE 400 PIV at 300 MA SPECIAL 2 FOR \$1 20 for \$7

rms/piv	rms/piv	rms/piv	rms/piv
17/25	35/50	70/100	140/200
14c	19c	29c	34c
rms/piv	rms/piv	rms/piv	rms/piv
210/300	280/400	350/500	420/600
43c	55c	70c	\$1.00
rms/piv	rms/piv	rms/piv	rms/piv
490/700	590/900	630/900	700/1000
\$1.25	\$1.70	\$1.70	\$2.00

Low Priced \* T200 SILICON DIODES rated 380piv/266rms @ 200Ma @ 100°C 36¢ each; 10 for \$3.25; 100 for \$27; 1000 for \$230

\* CAPACITOR INPUT DERATE 20% (\$5 or more this item we pay P.P./U.S.A.)

**"TAB" SPECIAL! TRANSISTORS DIODES!!! FULL LENGTH LEADS**

Factory Tested & Guaranteed! U.S.A. Mfgd!

PNP HIPOWER 15 Amp Max 25°C  
2N441, 2N277 \$1.80 @ 6/\$9, 25/\$35, 100/\$130, 2N442, 2N278 \$3.50 @ 3/\$12, 25/\$66, 100/\$225, 3 Amp, 2N155, 2N156, 2N255, 2N256, 2N307, 2N554, TO3GP €80 @ 20/\$15, 100/\$65.

2N123	PNP €45 @	12 for \$5, 100/\$37
2N292	2N293 PNP €45 @	12 for \$5, 100/\$37
2N223	PNP \$10c	12 for \$5, 100/\$37
2N597	2N598 PNP \$1.90 ea.	6 for \$10
2N598	PNP \$1.90 @	6 for \$10
2N599	PNP \$3.50 @	6 for \$10
2N670	PNP 300MW 95¢ @	8 for \$5, 100 for \$48
2N671	PNP/1W \$1.15, @	5 for \$4, 100 for \$69

GENERAL PURPOSE-PNP-COMPUTER GRADE!  
Use as Amplifier-Oscillator-HEF Logic-Nervoamp-Power Supply Pulse Amplifier or High Current Switch Vcb, Vce, Vcb Approx 40V GP 3C rated 300mw €65 @ .10 for \$5, 100/\$39 GP10C one watt 90¢ @ .6 for \$5, 100 for \$63.

2N176 \$1.80, 2N177 \$1, 2N178 \$1.75, 2N247 \$1.50, 2N270 95¢, 2N274 \$1.25, 2N408 80¢, 2N544 \$1.20, 2N578 \$1.80, 2N579 \$2.20, 2N581 \$1.25, 2N582 \$2.10, 2N670 \$1.60, 2N671 \$2. KIT TRANSISTORS PNP 39¢ ea., 3 for \$1. KIT TRANSISTOR PNP 39¢ ea., 3 for \$1. ROUND or DIAMOND BASE MICA Mid Kit 30: POWER HEAT SINK WITH FINS 80 Sq. \$1.25, KIT GLASS DIODES COMPUTER 20¢ ea., 8 for \$1.

TOP HAT SILICON DIODE EXPERIMENTERS KIT. USE AS STABILIZERS, ZENER DIODES & METER PROTECTION DIODES. CLIPPER & RECTIFIER DIODES! A \$10 VALUE, 8 for \$1, 50 for \$5/Ppd.

Qty Discounts to Volume Buyers (\$10 or more this item we pay P.P./U.S.A.)

**★ NEW "TEKSEL" SELENIUM RECTIFIERS FULL WAVE BRIDGE RECTIFIERS. ONE YEAR GTD!**

AMP.	18VAC	36VAC	72VAC	144VAC
CONT.	14VDC	28VDC	56VDC	112VDC
1AMP	\$ 1.30	\$ 2.00	\$ 4.90	\$ 8.50
2AMP	2.15	3.00	6.25	12.30
3AMP	2.90	4.00	8.60	16.75
6AMP	4.15	6.00	18.75	36.15
10AMP	6.10	12.15	26.30	48.90

Write for Complete Rectifier Catalog

"SUNTAB" @ BATTERY-SELENIUM PHOTOCELL  
2BP 75Mu 3/4x5/8" 40c @ 11 for \$4; 5AP/1" Rd. 58P/5q & Rect 220Mu 55c @ 12 for \$6; 15 AP 750Mu 1 1/2" Dia. \$1.45 @ 4 for \$5; 10BP 350Mu, 11-1/16" Rect. 75c @ 10 for \$7; 10CP 750 Mu. 1 7/8x1 3/8" \$1.45 @ 4 for \$5; Kit Self Generating Photocells 4 for \$1

SILICON POWER DIODE STUDS! 50Piv/35rms Factory Tested Gtd. 35 Amp. \$2.75 @ 2 for \$5.50, 25/\$50 70 Amp \$4.45 @ 2 for \$8.15/\$45 240 Amp \$9.45 @ 2 for \$18. 8/\$58

This item postpaid U.S.A. \$20 or more

TERMS: Money Back Guarantee! Our 17th year. 52 min. order F.O.B. N.Y.C. Add ship charges or for C.O.D. 25¢ dep. Prices shown subject to change.  
**"TAB"** 111-GF LIBERTY ST., N.Y. 6, N.Y.  
Send 25¢ PHONE: RECTOR 2-6245 for Catalog



sponse ±1 db 20-40,000 cycles. IM distortion 1 1/2%; harmonic distortion 1/2% at 24 watts continuous power output. Damping factor 5.—Sherwood Electronics Laboratories Inc., 4300 N. California, Chicago 18, Ill.

STEREO AMPLIFIER AND PREAMP, LA-240. 40 watts; terminations for 8- or 16-ohm speakers. Frequency response 12 to 100,000 cycles ±1 db at 1 watt; 50 to 70,000 cycles per second ±1 db at full output. Sensitivity at high level input 0.75 volt; magnetic phono inputs 5.5 mv

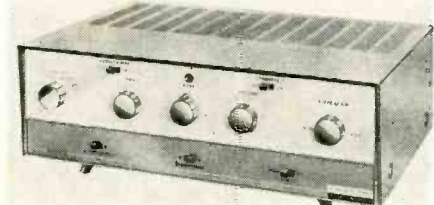

at 1 kc.—Lafayette Radio Corp., 165-08 Liberty Ave., Jamaica 33, N. Y.

STEREO POWER AMPLIFIER, model 290, with meter-monitored output circuits. At maximum output, harmonic distortion 0.5%; first-order in-



termodulation distortion 0.1%. Aluminum chassis.—H. H. Scott, Inc., Dept. P, 111 Powdermill Rd., Maynard, Mass.

STEREO CONSOLE, HFS-26, 28 watts. AJ-10 stereo AM-FM tuner, SA-2 stereo amplifier, AD-50A stereo changer, with G-E VR-227 cartridge, 2 WS-3 coax speakers, Equipment cabi-

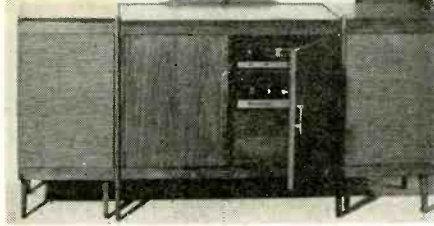

net, two 12-in speaker cabinets. Walnut or mahogany.—Heath Co., Benton Harbor, Mich.

STEREO TAPE RECORDER, Continental 200 (model EL3541), operates at 7 1/2 in per sec. 4 tracks. Frequency response 50-14,000 cycles per second. Wow and flutter less than ±0.3% (peak to peak). Line input 117 volts ac, 60 cycle.



13 1/2 x 11 1/2 x 6 1/2 in.—North American Philips Co. Inc., High-Fidelity Products Div., 230 Duffy Ave., Hicksville, N. Y.

REVERBERATION UNIT, model 8-1-C. Magnetic driver, 2 ceramic pickup transducers and coiled-spring delay line. Produces short delay in audio signal which causes spatial effect upon repro-

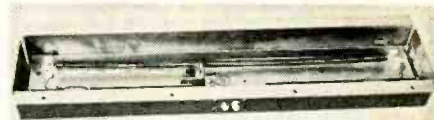

duced signal.—CBS Electronics, Information Services, 100 Endicott St., Danvers, Mass.

SPEAKER SYSTEM, Realistic Electrostat-2. 8-inch woofer and 4-element electrostat tweeter. Sensitive frequency response 30-25,000 cycle system. 8 ohms impedance. 20-watt power capacity. Network crossover at 7,500 cycles. Resonant fre-

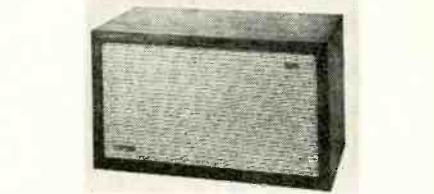

quency of 45 cycles.—Radio Shack Corp., 730 Commonwealth Ave., Boston 17, Mass.

BI-DIRECTIONAL SPEAKER, model RL-10B, for sound paging and public address. Acoustic sound chamber divides sound equally from single standard driver; reinforces low and high fre-

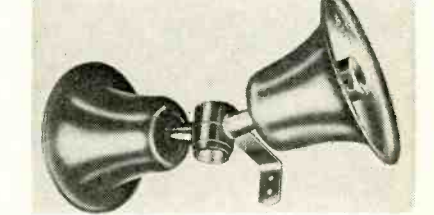

quencies.—Racon Electric Co. Inc., 1261 Broadway, New York 1, N. Y.

12-INCH WOOFER, model No. W12J616, for totally enclosed cabinets. Voice-coil impedance



16 ohms with frequency range from 20 to 4,500 cycles.—Oxford Electric Corp., 3911 S. Michigan Ave., Chicago 53, Ill.

LOUDSPEAKER SYSTEM, Sonoteer, employs 5 speakers. 4 x 21 x 25 in. Oil-rubbed walnut



frame. 18 lb.—Rek-O-Kut Co. Inc., 38-19 108th St., Corona 68, N. Y.

CERAMIC PHONO CARTRIDGES, 16T (shown) 18T, 16T channels separated by full 22 decibels. Flat response, ±1 db from 20 to 10,000 cycles

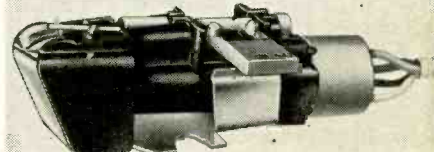

with smooth rolloff to 12,000 cycles. Compliance figure 2.4 x 10^-6 cm/dyne. Voltage output 0.50. 18T provides 0.70 volt with channel separation 20 db and compliance 1.5 x 10^-6 cm/dyne.—Sonotone Corp., Elmsford, N. Y.

BACKGROUND-MUSIC AMPLIFIER, model G22, for music and voice announcements. 20 watts. Program selector permits choice of tuner, tape, phono or 600-ohm telephone line. Separate volume controls to mix microphone with music. Protective caps on base and treble controls.—



Grommes Div. of Precision Electronics Inc., 9101 King St., Franklin Park, Ill.

**4-TRACK TAPE DECK**, for stereo or mono, RP-100. 14 transistors, separate push-pull bias-erase oscillator, full-wave rectifier, hysteresis

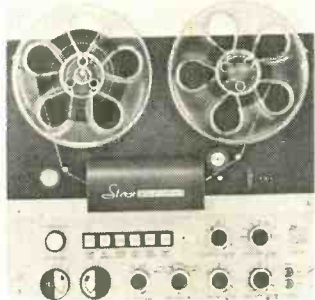

synchronous capstan drive motor and 2 heavy-duty 4-pole induction reel motors. At 7½ ips, frequency response 30-15,000 ±2db, noise 55 db below maximum recording level, wow and flutter 0.2%. At 3¾ ips, frequency response 30-10,000 cycles ±2 db, wow and flutter 0.25%.—EICO (Electronic Instrument Co. Inc.), 33-00 Northern Blvd., Long Island City 1, N. Y.

**TAPE-TO-SLIDE SYNCHRONIZER**, Mark-Q-Matic model MQM-1, records and cues to slides



with pencil mark. Self-contained, needing no installation onto or into tape recorder or projector. —General Techniques Inc., Dept. MP, 1270 Broadway, New York 1, N. Y.

**DELAY-DISTORTIONLESS FILTERS**. PPC Series, for high-reliability missile use. Available



in low, high and bandpass versions with wide band width and sharp rolloffs.—SEG Electronics Co. Inc., 12 Hinsdale St., Bklyn. 7, N. Y. END

All specifications from manufacturers' data.

### CORRECTIONS

The base and emitter terminals are transposed in the base diagram of the 2N207 transistor in the Mini-Pack amplifier schematic on page 51 of the April issue. Our thanks to Robert Thompson of Riverside, R. I.

Sharp-eyed Paulo Andersen of Blumenau, S. C., Brazil, spotted the shorted heater circuit in the preamplifier diagram on page 46 of the March issue. Naturally, the vertical line to the left of pins 4 and 9 of V3 should be removed.

# BUY A DOZEN VU-BRITES



... get the Tool Kit  
**FREE!**

Eight American-made wrenches—to give you every wrench needed to service all volume controls and all TV knobs with set screws—yours free with the purchase of 12 Vu-Brites!

### WHAT A DEAL!

For a limited time, Perma-Power is offering you this wonderful gift *absolutely free* with the purchase of 12 Vu-Brites at the regular price. Vu-Brites are the brighteners that really do a job —on series or parallel sets (Model C401 for parallel; Model C402 for series). They come colorfully packaged in individual boxes . . . and are priced at \$9.95 the dozen, net.

Hurry—this special gift offer will end when current stocks are gone. Call your distributor today.

**Perma-Power** COMPANY

3100 N. ELSTON AVENUE • CHICAGO 18, ILLINOIS

**FREE JUMBO PAK** OF YOUR CHOICE LISTED BELOW  
with every \$9 order

IMAGINE! RADIO 'N TV ASSORTMENTS BY THE POUND! LEKTRON EXCLUSIVE

<input type="checkbox"/> One Pound—Worth \$75 <b>TUBULAR CONDENSERS</b>	<input type="checkbox"/> One Pound—Worth \$95 <b>HI-Ω CONDENSERS</b>	<input type="checkbox"/> One Pound—Worth \$85 <b>CERAMIC CONDENSERS</b>
<input type="checkbox"/> One Pound—Worth \$90 <b>DISC CONDENSERS</b>	<input type="checkbox"/> One Pound—Worth \$70 <b>Discs-Ceramic TUBULARS</b>	<input type="checkbox"/> One Pound—Worth \$75 <b>DISCS &amp; CERAMICS</b>

400 TO 1000 PCS. PER PAK  
**\$3<sup>00</sup>** per pound

MONEY BACK GUARANTEE!



FREE GIANT BARGAIN CATALOG WRITE FOR YOURS!

HOW TO ORDER: Include check or M.O. with sufficient postage; excess returned. C.O.D. orders, 25% down; rated, net 30 days. INCLUDE POSTAL ZONE in address.

**LEKTRON** 241 Everett Ave. CHELSEA 50, MASS.

Clip out & mail.

# RCA MARK VII RADIO-PHONE



"TOP-OF-THE-LINE"  
CITIZENS' BAND  
2-WAY RADIO  
EQUIPMENT—  
GIVES YOU  
THE MOST!

## PROVEN PERFORMER FOR BUSINESS OR PLEASURE

This quality equipment from the leader is a leader in performance . . . dependability. Operates from car, home, office, boat or truck. Terrific for business or pleasure two-way communications. Can be used at any location having 6 or 12 volt DC or standard 115 AC power source.

High reliability, stable reception, solid transmission. Provides four crystal controlled channels for both transmit and receive; also manual receiver tuning for all 23 channels. A tremendous value from the leader!

See your RCA Radio-Phone Dealer. Or mail coupon.



Manufacturer's Nationally Advertised Price

RADIO CORPORATION OF AMERICA  
Telecommunication Center  
Dept. W-421  
Meadow Lands, Pa.

Please send me FREE literature on the new RCA Mark VII Citizens' Band 2-Way Radio.

NAME \_\_\_\_\_

ADDRESS \_\_\_\_\_ PHONE \_\_\_\_\_

CITY \_\_\_\_\_ ZONE \_\_\_\_\_ STATE \_\_\_\_\_

ADDITIONAL SALES OUTLETS are now being considered. Sell the Citizens' Band favorite! Write for further details now!



The Most Trusted Name in Electronics  
RADIO CORPORATION OF AMERICA

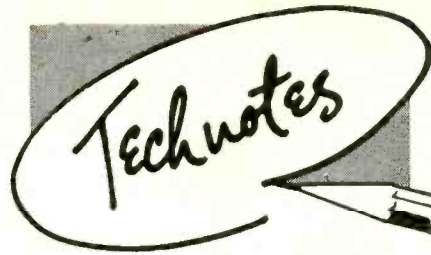

### PHILCO TV 7L40

When horizontal sync goes out on these and similar models using selenium rectifiers for horizontal afc, first try adjusting the auxiliary horizontal hold control (reached from the front of the set through the hollow shaft of the horizontal hold control). Next try horizontal phasing (the screwdriver adjustment on the chassis near the 12AU7 horizontal oscillator tube). If these adjustments are too critical or the sync drifts off after a short while, replace the selenium double-diode unit (located on the top right

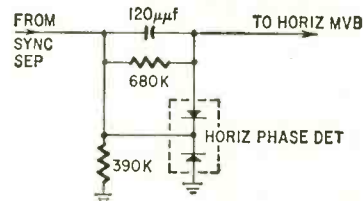

corner of the printed-circuit strip, near the horizontal phasing coil).

**CAUTION:** Use only a small soldering pencil to install a new diode. Do not use a soldering gun—the ac field around it can damage or ruin the diode. Avoid overheating or excessive pressure on the printed circuit too. Installation time and possible damage to the printed circuit can be reduced by clipping the old diode leads above the strip and soldering the new diode leads to these instead of to the printed-circuit foil itself.—John B. Ledbetter

### MOTOROLA CHASSIS TS-542

The raster would bloom when the set was first turned on. After operating for a while, raster became normal. A check of the high-voltage circuit revealed no defects. As a last possibility, we replaced the 3A3 high-voltage rectifier. Receiver operation returned to normal.—M. L. Leonard

### TELEFUNKEN STEREO 5083-WK

A common fault with these models is blowing the 1-amp fuse when the set is first turned on or when the ac off-on switch is turned on and off several times in succession.

To cure the problem, insert a 2-amp slow-blow fuse. The 1-amp fuse supplied works OK on 230 volts but, when used with 117-volt 60-cycle current, the inductance of the set's power transformer kicks back enough current to blow it.—George P. Oberto

### CLUES FOR CHECKING CAPACITORS

A capacitor can fail in several ways. It may short, develop leakage or open, or its capacitance may change. To determine whether the capacitor is leaky or shorted, don't disconnect it from the circuit and test it with an ohmmeter. Often, leakage will not show up unless the capacitor is subjected to the voltage that is normally across it, and an ohmmeter test will not indicate the defect. Instead, disconnect the capacitor (C1 in the diagram, for example) at the low-voltage side. Connect a voltmeter between the free end of the capacitor and ground. If C1 is shorted or leaky, part of the voltage applied to the other side of it will be indicated on the voltmeter.

When checking a suspected bypass or filter capacitor, disconnect it at the ground side and connect the voltmeter between the low side of the capacitor and ground (C2 in the diagram). With the set turned on, the meter will show part or all of the screen-grid voltage if C2 is leaky or shorted.

To test a high-capacitance unit (1  $\mu$ f or more), connect it



across a source of dc power where the voltage is equal to, or less than, the dc voltage rating of the capacitor. If the capacitor is polarized, be sure to connect the positive terminal to the positive side of the power source. After power is applied for a few minutes, remove the capacitor and bring the terminals close together. If you see a spark, the capacitor is not completely shorted or open.

A variable tuning capacitor or air trimmer can become shorted or leaky. To test for either condition, disconnect one end from the circuit and then test in the same manner as for other capacitors. Check for bent plates and for foreign matter between the plates. Then, while observing the

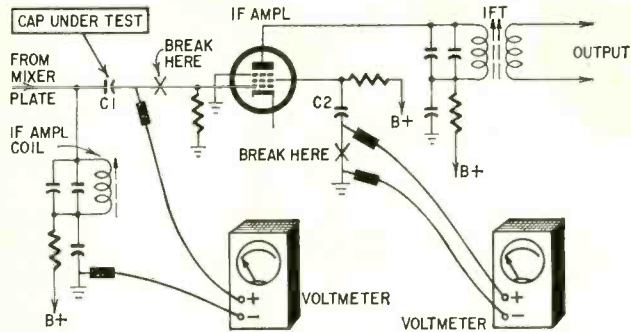

needle of an ohmmeter, move the rotor plates through their complete range. If the abnormal condition has been remedied, the ohmmeter will read infinity over the complete range of rotation.—*Barron Kemp*

### SYLVANIA CHASSIS 1-544-3

A couple of these sets were pulled to the shop for excessive hum. A careful check showed no circuit faults, and scope tracing revealed the hum was caused by a ground loop on the printed-circuit board. To repair this trouble, we removed the ground between the volume control and the tuner leads. Now the control was grounded only through the shield on

## WE BUY TECHNOTES

Attention all service technicians! RADIO-ELECTRONICS will pay you \$5 for each acceptable item you send us for the Technote column. Acceptable circuit diagrams used to illustrate the item raise the basic price to \$9. Acceptable photos are worth \$7 each. We especially want Technotes on specific models (see the Ford M-4 and Philco TV 7L40 here). So write up that tricky or interesting service job and rush it to: Technotes Editor, RADIO-ELECTRONICS, 154 W. 14 St., New York 11, N. Y.

the audio cable. Near the 5T8 on the set's chassis is the shielded cable feeding audio to the 5T8. The cable's shield is grounded to a lug. We removed the shield from this lug and regrounded it to the ground lead of the 2- $\mu$ f 50-volt discriminator capacitor. Such a procedure, grounding the volume control at the discriminator, is a handy hum-reducing method in hi-fi FM tuners too.—*Warren Roy*

### FORD AUTO RADIO—M-4

The complaint was intermittent cutting out with operation restored by kicking.

After much testing, the bias to the mixer and two if stages was monitored while the set was bounced gently on the

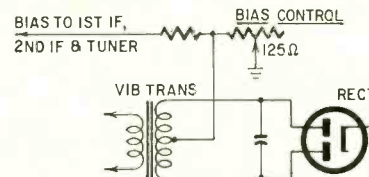

bench. The bias changed sharply with some bounces. Trouble was due to a bad contact on the bias supply resistor, a 125-ohm potentiometer. The pot was cleaned and lubricated. The trouble was cured.—*A. R. Clawson* END



## THIS is the microphone for mobile use THE TURNER 350C

Good performance on mobile operations — citizen's band, 2-way commercial radio and amateur radio — requires a microphone designed for mobile use. Tape recorder type mikes can't do the job. The Turner 350C is a reasonably priced, ceramic microphone especially designed for quality voice reproduction. DPST switch is wired for relay operation with easily reversible terminals to allow modification (if necessary). A wiring diagram is enclosed with each microphone. Hanger button and standard dash bracket are included for mobile rig mounting. Microphone furnished with 11" retracted (five foot extended) Coiled Cord. Response: 80 to 7000 cps. Output: -54 db. List price: \$16.80 complete. See your electronic parts distributor. He has the Turner 350C in stock.

**THE TURNER MICROPHONE COMPANY**  
933 17th Street NE  
Cedar Rapids, Iowa



By far the **BEST VALUE** obtainable in either wired or kit form . . . compare and you'll agree **"THE BEST BUY IS EMC."**

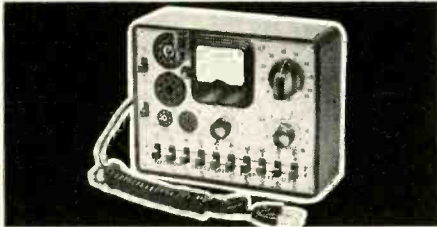

**EMC Model 211 Tube Tester**—The smallest, lowest priced, domestic made tube tester on the market. It is completely flexible and obsolescent proof. It checks each section of multi-purpose tubes separately, checks all octal, loctal, 9 prong and miniature tubes for shorts, leakages, opens, intermittents as well as for quality. Quality is indicated directly on a two color meter dial using the standard emission test. Comes complete with instructions and tube charts in ring bound manual. Size 6 3/4" x 5 1/4" x 2 1/4" deep. Shipping weight: 3 lbs. Wired ..... \$22.90 Kit ..... \$14.90  
CRT Picture Tube Adapter ..... \$ 4.50

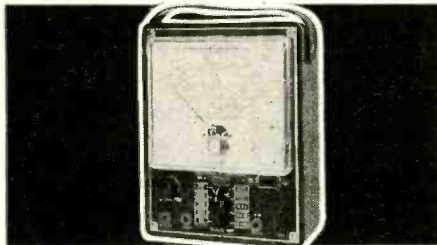

**EMC Model 109 — Voltmeter**—Features 20,000 OHMS volts DC sensitivity and 10,000 OHMS per volt AC sensitivity. Uses a 4 1/2, 40 microampere meter, with 3 AC current ranges, and 3 resistance ranges to 20 megohms. 5 DC and AC voltage ranges to 3000 volts and 3 DC current ranges; also 5 DB range.  
**Model 109** — With carrying strap, Weight 2 lbs. 5 ozs.; Size: 5 1/4" x 6 3/4" x 2 7/8" ..... \$26.95  
**Model 109K** — Kit Form ..... 19.25  
**Model HVT** — 30,000 Volt Probe for Model 109 ..... 7.95



**EMC Model 107A — Peak to Peak Vacuum Tube Volt-Ohm Capacity Meter** — 6" meter cannot burn out — entirely electronic. Measures peak to peak AC voltages to 2800 volts in 6 ranges. Measures capacity in 6 ranges from 50 mmfd to 5000 mfd. Measures resistance in 6 ranges from .2 ohm to 1000 megs. Measures DC volts to 1000 volts in 6 ranges. Input resistance to 16.5 megs. Wired ..... \$51.40 Kit ..... \$36.50

Yes, tell me more, send me **FREE** a detailed catalog of the Complete EMC Line. Dept. RE-661

NAME .....  
STREET .....  
CITY ..... STATE.....

**EMC** Electronic Measurements Corp.  
625 B'way, New York 12, N. Y.  
Ex. Dept., Pan-Mar Corp., 1270 B'way, New York 1, N. Y.

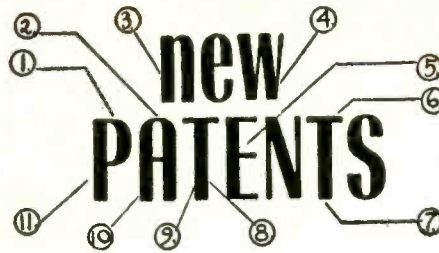

### AUTOMATIC FEED CONTROL

Patent No. 2,962,630

Robert S. Webb, Franklin, Mich. (Assigned to Elox Corp., Royal Oak, Mich.)

This invention controls the gap between a movable electrode and a fixed workpiece being machined in electrical discharge or electrochemical machining equipment. A dc or pulsating voltage across the gap erodes or removes stock from the workpiece. This gap must be maintained at optimum length.

Gap voltage varies with gap width. The voltage charges C, part of the V1 bias network. The gain of the two-stage amplifier V1-V2 is adjusted as follows: When the gap is optimum and C is charged 0.1 volt more positive than E1, the drop across R should equal E3. Since R opposes E3, motor M remains de-energized.

If for any reason the gap becomes greater, C biases V1 to greater conduction, V2 passes more current through R, and the drop exceeds E3. M rotates in a direction that moves the electrode closer to reduce the gap.

If the gap is too short, the drop across R is smaller than E3. M reverses and moves the electrode back, increasing the gap.

Sensitivity is very high. A change of 1 volt across the gap is enough to reverse the motor from maximum speed in one direction to maximum speed in the other.

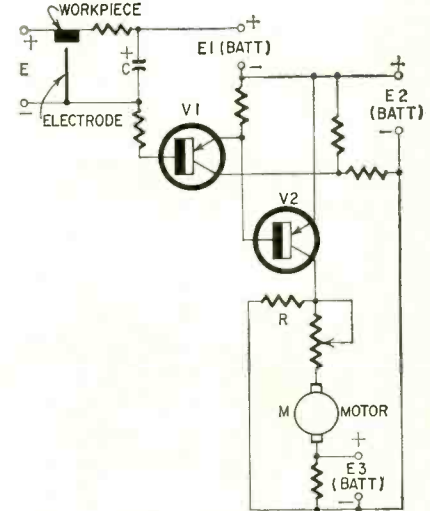

**FREE** **ALLIED**  
SPECIAL MONEY-SAVING  
ELECTRONIC SALE BOOK



**SAVE MOST** on Allied Summer Specials! Terrific closeouts on quality Stereo hi-fi systems and components, tape recorders, phonos, records and tape. Top buys in Allied's own **KNIGHT**® products and exciting build-your-own **KNIGHT-KITS**®. Hundreds of specials in radios, cameras, TV accessories, Citizens Band radio, amateur gear, P. A. systems, test instruments, tools and electronic parts. Dozens of new electronic products. Save as never before! Write today for this big Sale Book.

**only \$2 down on orders up to \$50** **ALLIED RADIO** **FREE Sale Book**

**ALLIED RADIO, Dept. 53-F1**  
100 N. Western Ave., Chicago 80, Ill.

Send Free Allied Sale Book No. 205  
Name .....  
PLEASE PRINT  
Address .....  
City ..... Zone ..... State .....

### TV PICTURE TUBES AT LOWEST PRICES

ALL ALUMINIZED GLASS TYPES			
Tube Type	Price With Old Tube	Tube Type	Price With Old Tube
108P4	7.95	17BJP4	11.50
12LP4	8.95	17CDP4	11.50
14AJP4	14.00	17CK/CA/BZ/BRP4	17.00
14ATP4	14.00	17DL/VP4	12.50
14B/E/CP4	10.00	17HP4	17.00
14HP4	11.00	17L/VP4	12.50
14QP4	11.00	17QP4	11.50
14RP4	11.00	20C/DP4	13.50
14W/ZP4	11.00	20H/MP4	14.50
14XP4	11.00	21AC/BS/1VP4	15.00
16DP4	12.00	AMP4	15.75
16K/RP4	9.95	21AL/ATP4	16.75
16LP4	12.50	21AU/AVP4	16.75
16TP4	9.95	21AWP4	15.75
16WP4	12.00	21BT/TP4	16.75
17AT/AVP4	12.50	21CBP4	16.75
17BP4	9.95		
		METAL TYPES	
12UP4	12.00	16GP4	14.50
16AP4	13.50	17CP4	17.00
16EP4	14.00	17GP4	17.00
		17TP4	17.00
		TEST TUBES	
		8XP4	16.07
		8YP4	16.07

**1 year warranty**  
Prices include the return of an acceptable similar tube under vacuum. These tubes are manufactured from reprocessed used glass bulbs. All parts and materials including the electron gun are brand new.  
**ALL PRICES FOR CHICAGO, ILLINOIS.** Deposit required, when old tube is not returned, refundable at time of return. 25% deposit required on COD shipments. Old tubes must be returned prepaid. Tubes shipped Rail Express. Shipped only to Continental U.S. and Canada.  
**WRITE FOR COMPLETE LIST**

**PICTURE TUBE OUTLET**  
2922 MILWAUKEE AVE., CHICAGO 18, ILLINOIS  
Dickens 2-2048

### HI-FI RECORDING TAPE

Splice Free (except 2400')  
15 day money-back guarantee

1200' 7"	Acetate	\$1.29	\$1.17	\$1.24	\$1.17
1800' 7"	acetate	1.79	1.59	1.45	1.45
1800' 7"	mylar	2.09	1.99	1.85	1.85
2400' 7"	mylar	2.99	2.69	2.49	2.49
2400' 7"	tensitized mylar	4.25	3.95	3.75	3.75

Can Be Assorted. Add 15c Postage Per Reel.  
10c For 24 Lot Orders.

HI-FI COMPONENTS TAPE RECORDERS available from wide variety of stock and shipped within 24 hours. Write for free wholesale catalogue. **WE WILL NOT BE UNDERSOLD.** Write us and see why.

**CARSTON** 125-RD East 88 St. New York, 28, N. Y.

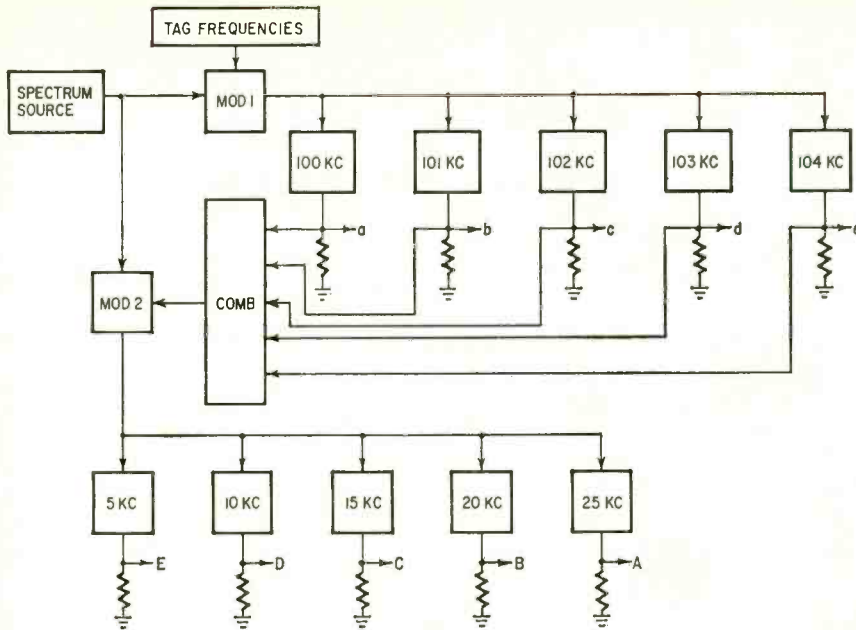

Fig. 1

## FREQUENCY METER

Patent No. 2,952,808

Hyman Hurvitz, Warner Bldg., Washington, D.C.

This instrument measures any integral frequency from 75 to 99 kc. A spectrum source, providing any frequency in the range, feeds modulator 1 (Fig. 1). The signal is mixed with (added to) one of the following "tag" frequencies: 25, 20, 15, 10 or 5 kc. These are labeled from A to E.

A group of filters, tuned respectively to 100, 101, 102, 103, 104 kc, passes output to a combining network and on to a second modulator. The filter frequencies are labeled a to e. MOD 2 output is the difference between its inputs, and equals one of the tag frequencies.

As an example, assume a 76-kc signal. Signal plus tag frequencies must add up to a filter frequency. Obviously, for 76 kc, the tag must be 25 kc and the filter frequency 101 kc. Corresponding to these frequencies is the letter pair Ab. Likewise, for any other frequency from 76-99 kc, there is a different letter pair.

To indicate the correct frequency, the inventor proposes the array of Fig. 2. Each intersection (for example, between A and b) is coated with an electroluminescent phosphor. When a given frequency appears, it causes a glow at the corresponding intersection. END

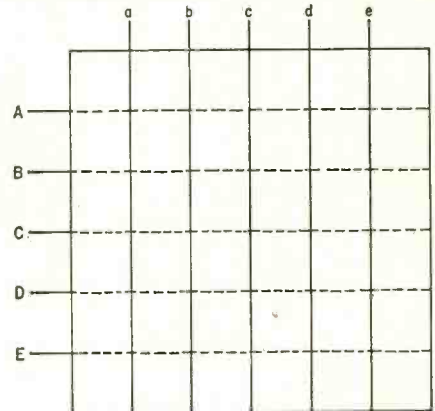

Fig. 2

## INDIVIDUAL TV VIEWER

Patent No. 2,955,156

Morton L. Heilig, New York, N.Y.

This inventor discloses his idea for 3D TV. He suggests a viewer like that used for 3D film viewing. It would be fitted with separate optical systems for each eye. These would focus onto small kinescopes fitted inside the viewer. The device would also be fitted with headphones with separate inputs for stereophonic reproduction. As another aid to give the viewer a sensation of reality, an air nozzle for each nostril would be provided. Scents, warm air, breezes, etc. could be driven through it, as desired. All this would

be combined into one piece to be worn on the head.

## PICK FOR ELECTRONIC MUSIC

Patent No. 2,961,912

Edward F. Meola, Palisades Park, N. J.

This relates to a magnetic pick for use with an electronic stringed instrument. The pick sets the steel strings into vibration, inducing an ac signal in the magnet windings, to be amplified as desired. The pick contains a permanent magnet which modulates the tone. The inventor claims only the magnetized pick.

## TV-RADIO Servicemen or Beginners...

Send for *Coyne's*  
7-Volume Job-Training Set  
on 7-Day **FREE TRIAL!**

Answers ALL Servicing Problems QUICKLY...  
Makes You Worth More On The Job!

Put money-making, time-saving TV-RADIO-ELECTRONICS know-how at your fingertips—examine Coyne's all-new 7-Volume TV-RADIO-ELECTRONICS Reference Set for 7 days at our expense! Shows you the way to easier TV-Radio repair—time saving, practical working knowledge that helps you get the BIG money! How to install, service and align ALL radio and TV sets, even color-TV, UHF, FM and transistorized equipment. New photo-instruction shows you what makes equipment "tick". No complicated math or theory—just practical facts you can put to use immediately right in the shop, or for ready reference at home. Over 3000 pages; 1200 diagrams; 10,000 facts!

**SEND NO MONEY!** Just mail coupon for 7-Volume TV-Radio Set on 7-Day FREE TRIAL! We'll include the FREE BOOK below. If you keep the set, pay only \$3 in 7 days and \$3 per month until \$27.25 plus postage is paid. Cash price only \$24.95. Or return set at our expense in 7 days and owe nothing. Either way, the FREE BOOK is yours to keep. Offer limited, so act NOW!

**"LEARNED MORE FROM THEM THAN FROM 5 YEARS WORK!"**

"Learned more from your first two volumes than from 5 years work."  
—Guy Bliss, New York

"Swell set for either the serviceman or the beginner. Every service bench should have one."  
—Melvin Masbruch, Iowa.

### FREE DIAGRAM BOOK!

We'll send you this big book, "150 Radio-Television Picture Patterns and Diagrams Explained" ABSOLUTELY FREE just for examining Coyne's 7-Volume Shop Library on 7-Day FREE TRIAL! Shows how to cut servicing time by reading picture-patterns, plus schematic diagrams for many TV and radio sets. Yours FREE whether you keep the 7-Volume Set or not! Mail coupon TODAY!



The First  
Practical  
TV-RADIO-  
ELECTRONICS  
Shop  
Library!

### Like Having An Electronics Expert Right At Your Side!

**VOL. 1—EVERYTHING ON TV-RADIO PRINCIPLES!** 300 pages of practical explanations; hundreds of illustrations.

**VOL. 2—EVERYTHING ON TV-RADIO-FM RECEIVERS;** 403 pages; fully illustrated.

**VOL. 3—EVERYTHING ON TV-RADIO CIRCUITS!** 336 pages; hundreds of illustrations, circuit diagrams.

**VOL. 4—EVERYTHING ON SERVICING INSTRUMENTS!** How they work, how to use them. 368 pages; illustrated.

**VOL. 5—EVERYTHING ON TV TROUBLESHOOTING!** Covers all types of sets. 437 pages; illustrations, diagrams.

**VOL. 6—TV CYCLOPEDIA!** Quick and concise answers to TV problems in alphabetical order, including UHF, Color TV and Transistors; 868 pages.

**VOL. 7—TRANSISTOR CIRCUIT HANDBOOK!** Practical Reference covering Transistor Applications; over 200 Circuit Diagrams; 410 pages.

ALL 7 BOOKS HAVE BRIGHT, MODERN, VINYL CLOTH WASHABLE COVERS

### FREE BOOK—FREE TRIAL COUPON!

Educational Book Publishing Division  
**COYNE ELECTRICAL SCHOOL**

1455 W. Congress Parkway, Dept. 61-T1, Chicago 7, Illinois

Yes! Send me COYNE'S 7-Volume Applied Practical TV-RADIO-ELECTRONICS Set for 7-Days FREE TRIAL per your offer. Include "Patterns & Diagrams" book FREE!

Name \_\_\_\_\_ Age \_\_\_\_\_

Address \_\_\_\_\_

City \_\_\_\_\_ Zone \_\_\_\_\_ State \_\_\_\_\_

Check here if you want Set sent C.O.D. Coyne pays postage on C.O.D. and cash orders. 7-Day Money-Back Guarantee.

**Coyne ELECTRICAL SCHOOL**

1455 W. Congress Parkway  
Dept. 61-T1, Chicago 7, Illinois



NOW...  
Master System  
Performance at a  
Home  
Booster  
Price!



## Blonder-Tongue signal master, AB-4

(new transistor, mast-mounted TV/FM 4-set booster)... \$29.95 list

- ✓ Transistor circuit provides lowest noise, maintenance free operation—no tubes to burn out or replace—no heat dissipation problems.
- ✓ Mast mounting takes advantage of best signal-to-noise ratio—minimizes snow. (Can also be mounted at any convenient point along the download.)
- ✓ World's smallest and lightest booster—no additional weight or wind resistance for mast to bear.
- ✓ Remote power supply at set uses 4 low-cost flashlight batteries for pure d.c.—eliminates AC power line, and components which may fail.
- ✓ Converts existing antenna into a powerful amplifier-distribution system—no need to invest in a new antenna.
- ✓ Eliminates costly installation of giant antenna arrays in most fringe areas.
- ✓ Provides improved FM reception (gain 12-15 db).
- ✓ Stripless 300-ohm terminals on booster and remote power supply for fast installation, positive contact.
- ✓ No separate balun needed—matches impedance of antennas and TV sets.

ALL THIS PLUS... 4 set coupler incorporated in remote control power supply distributes fully isolated amplified signals for brilliant reception on up to 4 TV or FM sets.

Improve TV and FM reception today. Add the new Blonder-Tongue AB-4. Sold thru distributors. For details write. RE6



<p>1 set gain: up to 19 db, channel 2 Up to 10.5 db, channel 13</p>	<p>2 sets gain: up to 14 db, channel 2 Up to 6 db, channel 13</p>	<p>3 sets gain: up to 13 db, channel 2 Up to 4 db, channel 13</p>	<p>4 sets gain: up to 10.5 db, channel 2 Up to 2 db, channel 13</p>
---	---	---	---

Patent applied for

engineered and manufactured by

# BLONDER-TONGUE

9 Alling St., Newark, N. J.

Canadian Div.: Benco Television Assoc., Toronto, Ont. Export: Morhan Export Corp., N. Y. 13, N. Y.  
home TV accessories • UHF converters • master TV systems • closed circuit TV systems

## NEW TUBES and SEMI-CONDUCTORS

Things are popping this month. We have a triple-triode Compactron, a tetrode nuvistor, and two TV transistors as our big guns. As a backstop, there's an audio power transistor, and a group of TV damper rectifiers.

7587

A sharp-cutoff general-purpose tetrode of the nuvistor type. It is designed for use in a wide variety of industrial and military small-signal applications requiring compactness, low current drain, relatively low-voltage operation, exceptional uniformity of characteristics from tube to tube, and

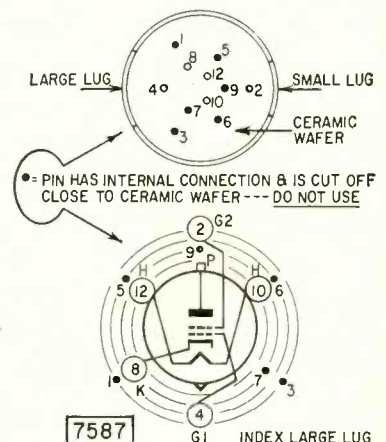
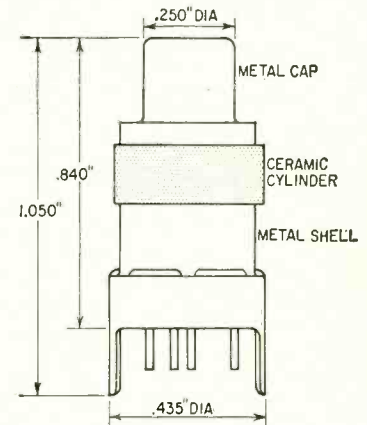

ability to withstand severe mechanical shock and vibration. These features plus its small size and light weight make it particularly suitable for rf-if, video amplifier and mixer service.

Characteristics of the RCA 7587 when

RADIO-ELECTRONICS

used as a class-A1 amplifier are:

$V_H$	6.3
$I_H$ (ma)	150
$V_P$ supply	125
$V_{G2}$ supply	50
$R_K$ (k ohms)	200
$g_m$ ( $\mu$ mhos)	10,600
$I_P$ (ma)	10
$I_{G2}$ (ma)	2.7
$V_{G1}$ (for 10- $\mu$ a $I_P$ )	-4.5

### 6K11

A Compactron device containing two high-mu triodes and one medium-mu triode. There are separate pin connections for all three cathodes, grids, and plates and an internal shield between sections 1 and 3. The 6.3-volt heater is rated at 600 ma and has controlled warmup time.

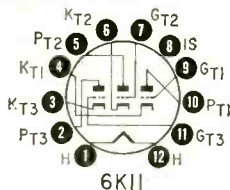

6K11

Typical operating characteristics of the G-E 6K11 Compactron are:

	Sec. 1	Sec. 2 & 3
$V_P$	250	250
$V_G$	-8.5	-2
$\mu$	17	100
$R_P$ (k ohms)	7.7	62.5
$g_m$ ( $\mu$ mhos)	2,200	1,600
$I_P$ (ma)	10.5	1.2

### 2N1707

A p-n-p germanium alloy junction transistor intended for use as an auto-

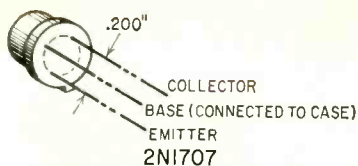

radio driver and Class A audio output amplifier. It features high reliability and excellent life characteristics. The base lead is connected to the case.

Maximum ratings of this Tung-Sol transistor are:

$V_{CBO}$	30
$V_{EBO}$	10
$V_{CE}$ ( $R_{BE}=1$ K ohm)	25
$P_C$ (mw)	200
$I_C$ (ma)	400

Electrical characteristics are:

$h_{re}$ ( $I_C=10$ ma, $V_C=-5$ v, $f=1$ kc) (min)	40
$f_{\beta}$ ( $V_C=6$ v, $I_C=1$ ma) (typical) (mc)	3

### 2N1752

A hermetically sealed germanium micro-alloy diffused-base transistor de-

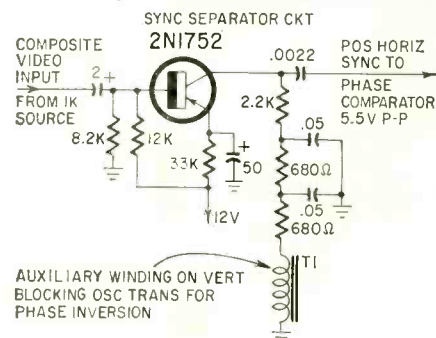

# WEAK

## TV signals get STRONG with new all-AC Winegard WBC-4X signal booster

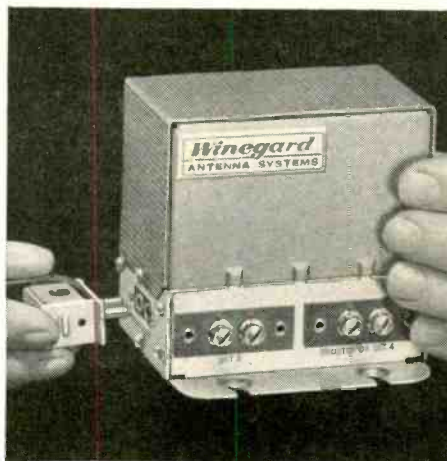

Here's a sure, easy way to deliver better TV reception to your customers — sell them a Winegard WBC-4X Signal Booster. Get new distance, cut snow, get more picture contrast. Winegard WBC-4X has one tube, 4 sets of no-strip lead-in terminals, on-off switch, antenna disconnect plug. Runs 1 — 4 sets. It's all AC — no "hot" chassis. Only \$27.50 list. Ask your distributor or write for technical bulletin.



Everything from antenna to set

# Winegard

ANTENNA SYSTEMS  
3013-6 Kirkwood, Burlington, Iowa



## MAD?

...because of cold solder joints?

World's Finest  
**ERSIN Multicores**  
FIVE-CORE SOLDER

Sold only by Radio Parts Distributors.

## CONVERT TO COLOR TV

**COLODAPTOR**—A simple 10-tube circuit and rotating color wheel converts any size B & W TV to receive compatible color TV.

**COLODAPTOR** — Easily attached to any TV set, does not affect normal operation, often built from parts experimenters have on hand. **BRILLIANT COLOR!**

Complete booklet—gives theory of operation, all construction details, schematic, and sample color filters. **ONLY \$1.95**

Essential Parts Kit—All Special Parts—Coils, Delay Line, Crystal, Color Filters

Up to 16" Sets—**\$19.95** 17" and Larger **\$20.95**

Other Kits, Wired Chassis, Motors Available

**COLODAPTOR**  
1798 Santa Cruz,  
Menlo Park, Calif.

Ask By Name For **GENUINE**

## "NO NOISE" PRODUCTS

your assurance of brand name quality

**NO-NOISE Volume Control and CONTACT RESTORER**

- Cleans & Lubricates
- Protects Not a Carbon Tet. Solution
- 2 oz. Bottle \$1.00
- 6 oz. Can \$2.25

Net to Servicemen



**NO-NOISE TUNER-TONIC with PERMA-FILM**

- Cleans, lubricates, restores all tuners, including wafer type.
- Non-toxic, non-inflammable.
- For TV, radio and FM use.
- Economical—a little does a lot.
- 6 oz. Aerosol Can \$3.25

Net to Servicemen



**FREE** at your jobbers

**5" PLASTIC EXTENDER**

included with each can



- Push Button Assembly
- For Pin-Point Applications
- Does Not Cause Shorts

**ELECTRONIC CHEMICAL CORP.**

813 Communipaw Avenue Jersey City 4, N. J.

# R-E Classified ADS

**Rates—50¢ per word (including name, address and initials. Minimum ad 10 words. Cash must accompany all ads except those placed by accredited agencies. Discount, 10% for 12 consecutive issues. Misleading or objectionable ads not accepted. Copy for August issue must reach us before June 10, 1961.**

**RADIO-ELECTRONICS, 154 West 14 St., New York 11, N. Y.**

**RENT STEREO TAPES**—over 2,000 different—all major labels—free catalog. **STEREO-PARTI**, 811-RE, Centinela Ave., Inglewood 3, Calif.

**BEFORE YOU BUY** Receiving Tubes or Hi-Fi Components send now for your giant **FREE Zalytron** current catalog—featuring nationally known Zalytron First Quality TV-Radio Tubes, Hi-Fi Stereo Systems, Kits, Parts, etc. All priced to Save You Plenty—Why Pay More? **ZALYTRON TUBE CORP.**, 220 W. 42nd St., N.Y.C.

**NEW CONCEPT OF LEARNING SELF-HYPNOSIS!** Now on tape or record! Free literature. **McKINLEY-SMITH CO.**, Dept. T5, Box 3038, San Bernardino, Calif.

**PROFESSIONAL ELECTRONIC PROJECTS**—Organs, Timers, Computers, etc.—\$1 each. List free. Refundable. **PARKS**, Box 1665, Lake City, Seattle 55, Wash.

**PROMPT DELIVERY**, we will not be undersold. Amplifiers, Tape Recorders, Tuners, etc. No. Catalogs, Air Mail Quotes. Compare. **L. M. BROWN SALES CORP.** Dept. R 239, E. 24th St., New York 10, N.Y.

**PRINTING PRESSES**, Type, Supplies, Lists 4¢. **TURNBAUGH SERVICE**, Mechanicsburg, Penna.

**LEARN WHILE ASLEEP**, Hypnotize with your recorder, phonograph or amazing new Electronic Educator endless tape recorder. Catalog, details free. **SLEEP-LEARNING ASSOCIATION**, Box 24-RD, Olympia, Wash.

**DISCOUNTS UP TO 50%** on Hi-Fi amplifiers, tuners, speakers, tape recorders, individual quotations only, no catalogs. **CLASSIFIED HI-FI EXCHANGE**, 2375 East 65th Street, Brooklyn 34, N.Y.

**DON'T BUY HI-FI COMPONENTS**, Kits, Tape, Tape Recorders until you get our low, low return mail quotes. "We Guarantee Not To Be Undersold." Wholesale Catalog Free. **HI-FIDELITY CENTER**, 220 RC E 23 St., New York 10, N.Y.

**CASH PAID!** Sell your surplus electronic tubes. Want unused, clean radio and TV receiving, transmitting, special purpose, Magnetrons, Klystrons, broadcast types, etc. Want military & commercial lab/test and communications equipment such as G.R., H.P., AN/UPM prefix. Also want commercial receivers and transmitters. For a fair deal write **BARRY**, 512 Broadway, New York 12, N. Y. Walker 5-7000.

**AMPEX**, Concertone, Crown, Magnecord, Presto, Norelco, Bogen, Tandberg, Sherwood, Rek-O-Kut, Scott, Shure, Dynakit, others. Trades. **BOYNTON STUDIO**, Dept. RE, 10 Pennsylvania Ave., Tuckahoe, N.Y.

**RAISED PRINTING BUSINESS CARDS**—\$3.99 per 1000. Samples. **EDWARD PRINTING SERVICE**, 7430 Selwick Drive, Parma 29, Ohio.

**ALL MAKES OF ELECTRICAL INSTRUMENTS AND TESTING** equipment repaired. New and used instruments bought, sold, exchanged. **HAZELTON INSTRUMENT CO.**, 128 Liberty St., New York, N.Y.

**COMPONENTS, Recorders, Tapes. FREE Wholesale Catalogue.** **CARSTON**, 125-T East 88th St., New York 28, N.Y.

**CB'ERS**—Special 5-minute sand type timer, ±15 sec accuracy. Full 3½" high, red and white trim. 89¢ including postage. No COD or stamps please. **F & S ELECTRONIC SERVICE**, 200 Maple Ave., Graterford, Pa.

**GUARANTEED COMPONENTS** Below net prices. **BIGELOW ELECTRONICS**, Box 1, Bluffton, Ohio.

**SCHEMATICS**, repair information. Radios—Amplifiers—Recorders 75¢. Television \$1.50. Send make & model. **STECKLER**, 223-21 65th Ave., Bayside 64, N. Y.

**WANTED—MISCELLANEOUS** Quicksilver Platinum, Gold, Silver. Ores analyzed. **MERCURY TERMINAL**, Norwood, Mass.

**TRANSISTORIZED** products dealers catalog, \$1. **INTERMARKET**, CPO 1717, Tokyo, Japan.

**DIAGRAMS FOR REPAIRING RADIOS**, television \$2. Give make and Model. **DIAGRAM SERVICE**, Box 672 RE, Hartford 1, Conn.

**I'M SEEKING** a portable TV set—8½" Admiral or RCA. Working or repairable. Metal case. State condition and price. **LORETO SCHOLSBERG**, Monteverde 240, Curacao, N. A.

**20 ASSORTED 1- and 2-tube circuit diagrams**: receivers, transmitters, amplifiers, power supplies, etc. 50¢, full-page diagrams. **ELECTRONICS SERVICES**, 16 Bayside Ave., Hamilton, Ontario, Canada.

**SCHEMATICS**. Radios, hi-fi, recorders, 75¢. Television \$1.50. Send make, model. **ZELECH**, 186 Monmouth, Red Bank, N.J.

**9-VOLT transistor batteries**, 2 for \$1. **BROWN'S**, 6114 Wissahickon, Philadelphia 4, Pa.

**SERVICEMEN**. Free confidential parts and equipment list. Unbeatable prices. **KNAPP**, 3174 Eighth Ave., Largo, Fla.

**NEW ELECTRONIC-SCIENTIFIC KITS**. Mine detectors, SW, experimental, printed circuits. Send 10¢ for catalog. **KITRONICS CORP.**, Dept. B, 6509 Whitman Ave., Van Nuys, Calif.

**HIGHLY EFFECTIVE** home-study review for FCC Commercial phone exams. Free literature. **WALLACE COOK**, Box 10634, Jackson 9, Miss.

**CATALOGS, GENERAL MERCHANDISE**, also specials, closeouts, televisions, radios, \$1.00, refundable. **WHOLESALE CATALOGS-RE**, 2569 No. 12 Street, Milwaukee 6, Wisconsin.

**ELECTRONICS RESEARCH SURPLUS** from leading Midwest manufacturer. 2½ lb, \$3.00. **PALAN ASSOCIATES**, 851 17 St. SW, Cedar Rapids, Iowa.

**UNDERSTAND SCHEMATICS**, blueprints easily. Send \$2.00. Special "Encyclopedia Drawing" \$9.00. Supply limited. **PRIOR**, 23-09 169 St., Whitestone 57, New York.

**RADIO & TV TUBES at Manufacturers' Prices!** 100% Guaranteed! Brand New! No re-brands or pulls! **UNITED RADIO**, Box 1000-R, Newark, N. J.

**TUBE TESTERS**. Check filaments, shorts, etc. \$14.95. P.O. Box 25864, Los Angeles 25, Calif.

**IMPORTERS CLOSEOUT:** We have approximately 160 UHER Stereo Record 3 tape recorders for immediate closeout. Many brand new, others slightly used, all require some repair. Supplied with schematic and instruction book. Sams folder available, parts available, literature upon request. List price \$399.50, as is \$185.00 each. Quantity prices quoted. See them at or write **KIMBERLEY INTERNATIONAL, LTD.**, 346 W. 44 St., NYC 36, N.Y. Circle 5 7425.

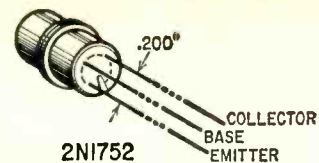

signed for use as a sync separator in TV receivers. In the circuit shown it will provide a horizontal sync pulse at the output of approximately 5.5 volts amplitude when driven from a composite video signal at the input whose amplitude is 0.7 volts, peak to peak, or higher.

Maximum ratings of the Philco 2N1752 at 25°C are:

V <sub>CB</sub>	12
V <sub>CE</sub>	12
V <sub>EB</sub>	2
I <sub>c</sub> (ma)	50
P <sub>total</sub> (mw)	60

Typical electrical characteristics are:

h <sub>fe</sub> (current amplification factor)	250
f <sub>max</sub> (max freq of oscillation) (mc)	106

## 2N1750

A germanium surface-barrier transistor for use as a horizontal oscillator in TV receivers. It features a low I<sub>OBO</sub> and, when used with low-impedance phase comparator networks, stable oscillator operation at temperatures to 55°C can be expected.

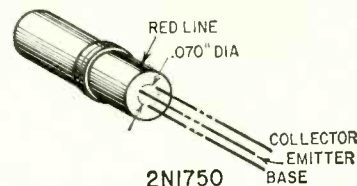

Maximum ratings of the Philco 2N1750 are:

V <sub>CB</sub>	14
V <sub>CE</sub>	6
I <sub>c</sub> (ma)	5
P <sub>total</sub> (mw)	15

Electrical characteristics are:

I <sub>CBO</sub> (collector cutoff current)	(μa)	2
(V <sub>CB</sub> = -1 v)	(μa)	50
(V <sub>CB</sub> = -14 v)	(μa)	40
h <sub>FE</sub> (current amplification factor)	(V <sub>CE</sub> = -3 V, I <sub>C</sub> = -0.5 ma)	40

## 6DM4, 12DM4, 17DM4

A group of half-wave vacuum rectifiers designed for use as damper diodes in horizontal deflection circuits of black-and-white TV receivers. All three tubes have identical ratings except for their heaters. The 6DM4 heater is rated at 6.3 volts, 1.2 amperes; the 12DM4—12.6 volts, 600 ma; the 17DM4 16.8 volts, 450 ma. The 12DM4 and the

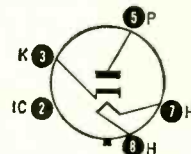

## 6DM4, 12DM4, 17DM4

17DM4 have an 11-second controlled-warmup time.

Maximum ratings in damper service for the RCA 'DM4 series are:

V <sub>p</sub> (peak inverse)	5.000
I <sub>p</sub> (peak) (amps)	1.1
I <sub>p</sub> (ma)	175
P <sub>p</sub> (watts)	6.5 END



### SILICON REPLACES SELENIUM

In the Try This One column on page 133 of the March 1960 issue, there is an item by Albert J. Krukowski on replacing selenium rectifiers in three-way portable radios with silicon diodes. This is a good idea, but an important point was not mentioned. The silicon diodes give higher output voltage than the seleniums because of their lower internal voltage drop. Therefore, this replacement may develop excessive voltages in the set which might damage the tubes. Carefully check voltages after switching rectifiers. It may be necessary to increase the value of the filament dropping resistor.—*Charles Erwin Cohn*

### POTENTIOMETER CALIBRATION

To calibrate a potentiometer (R1 in the figure) in terms of a low fixed

resistor (R2), connect them in series across a voltmeter and use a spdt switch to short either of them (as shown) or simply shift the meter leads. For the first calibration point, short the pot (R1) and note the ohmmeter

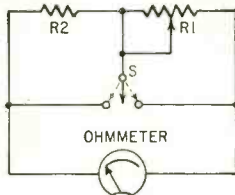

reading for R2, then short R2 and set R1 to the same reading. For the second point, open S and measure R2 plus R1. Then short R2 and increase R1 until it gives this same reading by itself. By repeating this process, you get a series of points R2 ohms apart, without ever depending on the calibration of the ohmmeter, and can plot a curve or mark a dial. The precision decreases as R1 becomes many times R2, but you can help it some by working from both ends, and still more by having several identical resistors in series for R2 (or using fixed multiples of R2).—*A. H. Taylor*

### HAND COUNTERSINK SAVES TIME

Almost daily I have some reason to countersink holes in wood to install flat-head wood screws. This means getting out the drill, inserting a countersink, connecting the tool (if it's electrical) for a simple task that takes

# COLOR TV IS BRIGHT, SHARP, TRUE WHEN YOU PLUG-IN A WINEGARD WBC4-X SIGNAL BOOSTER

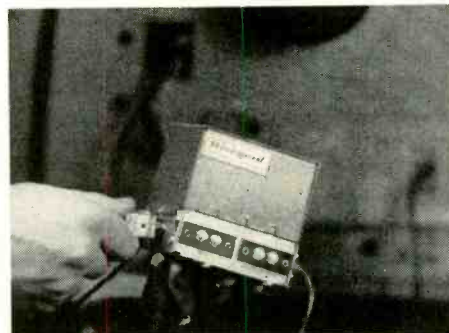

For *REALLY* good color reception, you need a strong signal. And you get it with a Winegard WBC-4X Signal Booster with up to 12.5 DB gain on all channels and flat frequency response. The WBC-4X has new ultra low noise 6DJ8 frame grid tube with AC isolation on BOTH filaments and plate—it's the only all AC Booster on the market—no "hot" chassis. Can also be used as a 4 set TV and FM amplified coupler.

Comes complete, ready to install—4 sets of no-strip terminals, on-off switch, antenna disconnect plug—only \$27.50 list. Ask your distributor or write for technical bulletin.



Everything from antenna to set

## Winegard

ANTENNA SYSTEMS  
3013-6 Kirkwood, Burlington, Iowa

**BUILD THE BEST HI-FI**  
save 1/2 with **EICO** KITS  
Model HFT94 AM Tuner

Model HFT90 FM Tuner  
**AM TUNER HFT94**  
Kit \$39.95 Wired \$65.95  
INCLUDES COVER & FET

- monaural AM reception, and/or
- STEREO AM-FM reception with matching EICO FM Tuner HFT90 or equivalent

NO technical experience is necessary. Each EICO kit comes complete with easy step-by-step instructions and picture diagrams — plus exclusive LIFETIME guarantee for service adjustment.  
Come in for a no-obligation demonstration.

NOW AVAILABLE AT  
**Almo RADIO CO.**  
913 ARCH ST., PHILADELPHIA, PA.  
201 CALHOUN ST., TRENTON, N. J.  
219 LANDIS AVE., VINLAND, N. J.  
1122 FRENCH ST., WILMINGTON, DEL.

## Purchasing A HI-FI SYSTEM?

TIME PAYMENTS AVAILABLE  
Up to 2 years to pay!

Send Us Your List Of Components For A Package Quotation

You Can Buy With Confidence AT AIREX

All merchandise is brand new, factory fresh & guaranteed.  
*Free Hi-Fi Catalog*

## AIREX RADIO CORPORATION

85-RE Cortlandt St., N.Y. 7, WO 4-1820

Jim Lansing\*  
Altec Lansing  
Electrovoice  
Hartley\* • Viking  
University • Jensen  
Acoustic Research  
Janszen  
Wharfedale  
USL Citizen Band  
Gonset  
Mallcraft  
Texas Crystals  
Concertone  
Bell • G. E.  
Weathers  
Harman-Kardon  
Eico • Pilot  
ESL  
Superscope  
Dual Changer  
Bogen • Leak  
Dynakit • Fisher  
H. H. Scott  
Thorns\* Sherwood\*  
TEC • Roberts  
DeWald  
Sony • Tandberg\*  
Challenger  
Wollensak  
Garrard  
Miracord  
Glaser-Steers  
Rek-O-Kut  
Components  
Norelco • Conrac  
Fairchild  
Pickering • Gray  
Audio Tape  
Magnecord\*  
Artizon Cabinets  
Rockford Cabinets  
\*Fair Traded

# We're pushing the full line...



(of **Centralab** Ceramic Capacitors)

Sometimes we get so wound up in talking about our "only from CENTRALAB" ceramic capacitors that we forget to remind you about the *standard* ones.

CENTRALAB has plenty of both—as well we should. We *pioneered* ceramic capacitors many years ago—and we still give you the finest product and the widest choice.

Discs, tubulars, buffers, trimmers, feed-thrus —for every standard and special application, in radio-tv servicing or industrial use —CENTRALAB makes them and makes them best. That's why CENTRALAB is the best ceramic capacitor line for you to buy.



THE ELECTRONICS DIVISION OF GLOBE-UNION INC.  
922F EAST KEEFE AVENUE • MILWAUKEE 1, WISCONSIN  
CENTRALAB CANADA LIMITED—AJAX, ONTARIO

D-61335

**ELECTRONIC SWITCHES • VARIABLE RESISTORS • CERAMIC CAPACITORS**

**PACKAGED ELECTRONIC CIRCUITS • ENGINEERED CERAMICS**

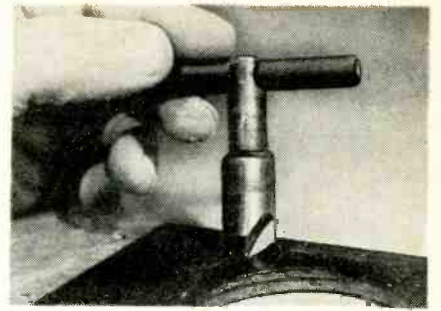

only seconds to perform. To end this nuisance, a hand-operated countersinking tool can be devised from a discarded drill bit that will handle most of this work easily. Drill a small hole for a pin in the shank of the drill bit as shown in the photo. Insert the pin—it should be a tight fit—and add two pieces of rubber tubing for a more comfortable grip. A quick turn or two of this tool in any wood will countersink the hole for the screw and there is no need for chucking and rechucking drill or auger.—*Glen F. Stillwell*

### LOANER BUILDS BUSINESS

Whenever a TV set conks out in a motel or hotel, we pull the chassis, leave the cabinet and place a loaner set atop the cabinet, along with a card reading "This set loaned by Advance Television Radio Service."

Since this is a resort town peopled by tourists and others who stay at a motel or hotel while they shop to buy a home for permanent residence, they see our ad, and this often results in that all-important first contact.

These people figure if our service is good enough for the motel or hotel, it is good for them to give us the first try.—*Harry J. Miller*

### TRY 6-SECOND SOLDER

Electronic service technicians who haven't yet tried the new 6-second solder should do so. The 50/50 tin-lead solder in paste form comes in very

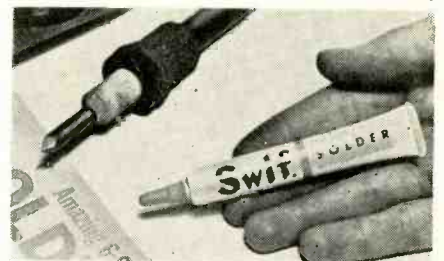

handy for delicate "closeup" soldering jobs where only a small amount of heat is permissible—soldering transistor leads and such. Your distributor can probably pick up a 1½-oz tube of the solder for you for less than 70¢. A little goes a long way.—*John A. Comstock*

### CLEAN PRESSURE ROLLERS

I have found an ink eraser excellent for cleaning the glaze from the pinch or pressure roller of tape recorders. It appears better than using liquid cleaners since it does not damage the rubber. And, of course, there's no chance of the remaining fluid damaging the tape should the recorder be used right away.—*W. A. Banton* END



# NOTEWORTHY CIRCUITS

## SIMPLIFIED REMO NEMO

The article "Remo Nemo" in the December (1960) issue intrigued me and started my relay-operated brain working on some improvements in the control circuits. The diagram shows my version. It has the advantages of simplified control switching, more positive operation of remote relays and the addition of a remote READY light and studio indicator lamps.

When the CONTROL switch is turned from OFF to READY, the CONTROL light in the studio lights to show that the control battery (BATT2) is in use. BATT2 is connected to the program line so RY1 operates through diode D1. (RY2 does not operate because D2 is blocked by reverse bias.) When RY1 operates, RY3 is energized from BATT1 and remote READY lamp is turned on through RY1's normally open contacts.

When the program material is to start, the operator in the studio turns

the switch to PROGRAM. The ON light in the studio indicates that the program line is connected to the studio console. The control battery has been removed from the line, causing RY1 to drop out, disconnecting the READY lamp and lighting the remote ON lamp.

At the end of the program, the control switch is thrown to STOP. The studio ON lamp goes out, indicating that the program line has been disconnected from the console. The CONTROL lamp indicates that BATT2 is

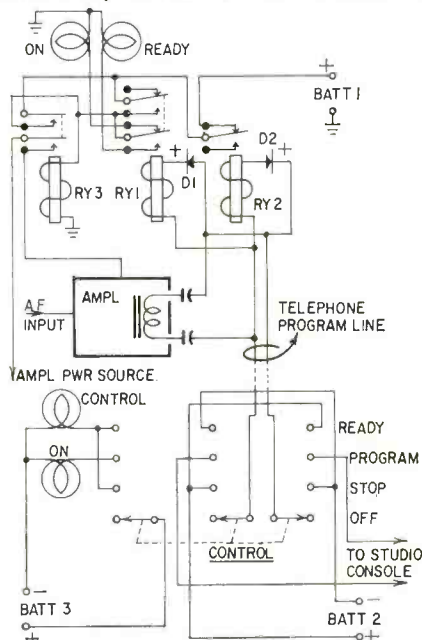

# QUICK SELLER from WINEGARD LOWEST COST COMPLETE TV AND FM DISTRIBUTION SYSTEM

Antenna, Mast,  
Base Mount,  
Insulators, Lead-In,  
AC Amplifier..... **\$42<sup>45</sup>** list

Here's everything you need for a complete TV and FM distribution system — all ready for simple, quick installation. Hook up to 4 TV and FM sets. System consists of:

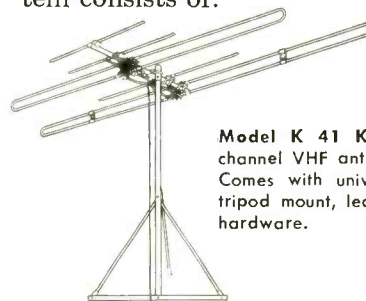

Model K 41 K all-channel VHF antenna. Comes with universal tripod mount, lead-in, hardware.

Model WBC-4X  
Amplifier-Coupler  
All AC — no "hot"  
chassis. Up to 6 DB  
gain each on 2, 3,  
4 sets, or 12.5 on one.  
6DJ8 tube, 4 sets no-strip  
terminals, quick disconnect  
plug on antenna  
lead.

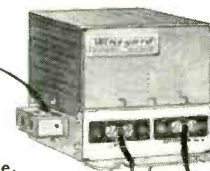

Optional — Winegard Plug-In Outlets, surface or flush mount as low as \$2.10 each.

Ask your distributor or write for complete information.



Everything from  
antenna to set

# Winegard

ANTENNA SYSTEMS  
3013-6 Kirkwood, Burlington, Iowa

**ENGINEERING DEGREE IN  
SCIENCE 27 or 36 MOS.  
MATH**

B.S. degree—36 mos. • B.E. degree—27 mos.

Accelerated year-round program prepares for early employment in fields of Science and Engineering. Regular 4-year program for B.S. Degree completed in 36 months, special engineering degree program in 27. Classes start June, July, September, January, March. Quality education. Graduates employed from coast to coast. Government approved for veteran training. Students from 50 states, 40 countries, 20 buildings; dorms, gym, Campus. Save time and money. Earn board. Write for catalog, 1761 E. Washington Boulevard, Fort Wayne 2, Indiana

## INDIANA TECHNICAL COLLEGE

**FREE! CATALOG OF  
HI-FI, RADIO, TV  
PARTS & ACCESSORIES —  
yours for the asking!**

**Vidaire** ELECTRONICS MFG. CORP.  
365 BABYLON TPKE. — ROOSEVELT, N. Y.

**PACKAGE HI FI  
or SINGLE COMPONENTS**  
You'll find our prices low  
and service fast.

Write for our quotation  
**CENTER INDUSTRIAL ELECTRONICS, Inc.**  
74-R Cortlandt Street, New York 7, N.Y.

to  
SERVICE  
CHARGES  
and  
RECORD  
KEEPING

## the business-like approach



For customer's prices on every replacement part, plus flat rate and hourly service charge data, regional and national. Dave Rice's OFFICIAL PRICING DIGEST, listing over 63,000 items. \$2.50.

▲ AVAILABLE FROM YOUR DISTRIBUTOR ▼

If you want to operate on a professional level, Dave Rice's OFFICIAL ORDER BOOKS give you triplicate forms for order, invoice, and office records... spaces for tubes, parts, serial numbers, labor and tax charges, signatures, etc. 75c per book, \$6.50 for dust-proof box of 10.



**ELECTRONIC PUBLISHING COMPANY, INC.**  
180 N. WACKER DRIVE • CHICAGO 6, ILL.

Take advantage of this

**Gold Seal Value**  
Save 50¢



**HOW TO FIX TRANSISTOR RADIOS & PRINTED CIRCUITS**

Gernsback Library Book No. 96.

In two volumes—\$5.90 if you buy the set. You'd pay \$3.20 each if bought separately. The book buy of the year at this special combination price! All the theory and practical knowledge you need to fix transistor radios and printed circuits—given in a remarkably easy-to-understand way. Tells how and why transistors work, why they amplify. Explains current and voltage gain and analyzes circuits. The hundreds of charts, diagrams and schematics (many blown up so you'll understand them easier) help you get right to the heart of the toughest troubles in minutes. Much of this material is presented here for the first time in print. The handy "instant servicing" reference section will fast become your workbench partner. Every service technician needs these books.

**TV TROUBLE ANALYSIS** No. 101.

By Harry Mileaf 224 pages \$3.20

A new approach to troubleshooting! Now by understanding the theory of trouble you can get to the root of any trouble fast. Tells how and why components and circuits break down and how that affects picture and sound. Get this book today.

**TRANSISTORS** No. 94.

96 pages \$1.95

A handy work-book for the technician, experimenter or technical student. Tells how to test transistors and how to build the equipment you need to do the job—plus some interesting all-transistor equipment. They've all been bench-tested! A selection of the best from **RADIO-ELECTRONICS** magazine.

**INTRODUCTION TO HI-FI** No. 88.

By Clement Brown 192 pages. \$3.20

Gernsback Library acquired exclusive rights to publish this British book in America. A thorough study of a familiar subject from a refreshingly different point of view. Gives you a foundation on basics then digs into practical descriptions of pickups, preamps, amplifiers, speakers, acoustics, changers, hi-fi in the future. Gernsback Library edition available only in U.S.A.

**RADIO CONTROL MANUAL** No. 91.

By E. L. Safford, Jr. 192 pages. \$3.20

How to build the ultimate R/C system. Starts with the most basic system and, by adding and modifying components, advances to a multi-channel system. There's a wealth of practical, do-it-yourself data here for both beginner and veteran.



**OTHER POPULAR GERNSBACK LIBRARY BOOKS**

**SERVICING**

- No. 102—Practical TV Troubleshooting. \$2.35
- No. 87—Practical Auto Radio Service & Installation. \$2.95
- No. 85—How to Get the Most Out of Your VOM. \$2.90
- No. 81—Printed Circuits. \$2.90
- No. 78—Rapid Radio Repair. \$2.90
- No. 76—Servicing Transistor Radios. \$2.90
- No. 72—Oscilloscope Techniques. \$2.90
- No. 68—TV and Radio Tube Troubles. \$2.90
- No. 65—Servicing Color TV. \$2.90
- No. 60—Rapid TV Repair. \$2.90
- No. 59—Servicing Record Changers. \$2.90
- No. 57—The VTVM. \$2.50
- No. 55—Sween and Mark-er Generators for TV and Radio. \$2.50

- No. 54—Probes. \$2.50
- No. 52—The Oscilloscope. \$2.25
- No. 49—Radio & TV Test Instruments. \$1.50

**SEMICONDUCTORS**

- No. 92—Fundamentals of Semiconductors. \$2.95
- No. 89—Transistor Projects. \$2.90
- No. 63—Transistor Circuits. \$2.75
- No. 61—Transistor Techniques. \$1.50
- No. 75—Transistors Theory & Practice. \$2.95

**HIGH FIDELITY**

- No. 98—Stereo: 1881—\$2.95
- No. 90—Hi-Fi Made Easy. \$2.90
- No. 85—Installing Hi-Fi Systems. \$3.20
- No. 80—Stereo—How it Works. \$2.90
- No. 79—Designing and Building Hi-Fi Furniture. \$2.90

- No. 73—Audio Measurements. \$2.90
- No. 71—Audio Design Handbook. \$2.90
- No. 67—Elements of Tape Recorder Circuits. \$2.90
- No. 66—Basic Audio Course. \$2.75
- No. 64—Understanding Hi-Fi Circuits. \$2.90
- No. 58—Maintaining Hi-Fi Equipment. \$2.90
- No. 56—High-Fidelity Circuit Design. (Cloth Bound.) \$5.95
- No. 48—High Fidelity—Design, Construction, Measurements. \$1.50

**HOBBIES**

- No. 83—Fun with Electricity. \$2.65
- No. 74—Model Radio-Control. \$2.65
- No. 70—Electronic Puzzles and Games. \$1.95
- No. 69—Electronic Hobbyists' Handbook. \$2.50

**FUNDAMENTALS—MISCELLANEOUS**

- No. 84—Marine Radio for Pleasure Craft. \$2.95
  - No. 82—Tubes & Circuits. \$3.45
  - No. 77—Guide to Mobile Radio. \$2.85
  - No. 62—TV—It's a Cinch. \$2.90
  - No. 45—Radio Tube Fundamentals. \$1.00
- Books paper bound unless otherwise noted.

In Canada: Len Finkler, Ltd. 1794 Avenue Rd. Toronto 12, Ont.

Export Agent: Feffer & Simons 31 Union Sq. New York 3, N. Y.

Prices slightly higher in Canada.

Gernsback Library, Inc., Dept. 31  
154 West 14th St., New York 11, N. Y.

Please send me postpaid the books listed below. My remittance of \$..... is enclosed.

Please list books by number

Name.....

Street.....

City.....Zone.....State.....

across the program line. RY2 operates through D2 to de-energize RY3, turning off the remote ON light and removing power from the amplifier.

Now, the control switch is turned to OFF, disconnecting BATT2 and the CONTROL lamp.

The control switch may be moved back and forth from PROGRAM to READY and the remote lamps will follow. Since the switch must pass through STOP to reach OFF, there is no way that the remote equipment can be left on with the studio control switch at OFF.—James H. West, Jr.

**SELECTIVE TRANSISTOR AMPLIFIER**

Selective amplifiers have many applications in electronics and instrumentation and are widely used as bridge null detectors and as channel selectors in remote-control equipment. The selectivity is generally developed by cascading L-C tuned amplifiers or by using Wien bridge, bridged-T or parallel-T networks in feedback circuits. Fig. 1 shows a transistor selective amplifier developed in the article "Selective RC Amplifier Using Transistors" in *Electronic Engineering* (London, England).

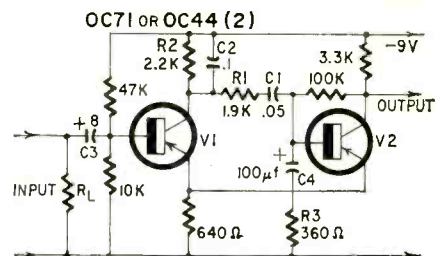

Fig. 1

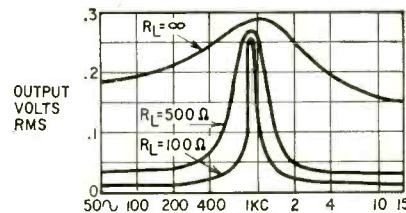

Fig. 2

The frequency selected is determined by a modified Wien bridge with a shunt arm consisting of R2 and C2 and a series arm composed of R1 and C1. RL is the collector load resistor of the preceding stage. The selectivity of the circuit increases as RL decreases. See Fig. 2.

The input coupling capacitor (C3) causes an error in the operating frequency. A capacitor (C4) in series with R3 compensates for low-frequency error. An inductance is used in place of C4 to correct for error at the high end.

**HEAVY-DUTY PHOTO-ELECTRIC CIRCUIT**

The photocell circuit shown delivers a husky output current which may be used to perform real work. The heart of the circuit is an inexpensive 2N255 power transistor. When the photocell is illuminated by a 40-watt incandescent lamp (at a distance of 1 foot), the dc

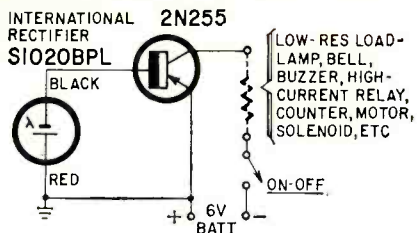

output through a low-resistance load device (not more than 25 ohms) is .25 ampere. This current may be used to drive such low-resistance dc devices as motors, lamps, buzzers, high-current relays, solenoids, actuators, mechanical counters, etc.

At higher illumination levels, the output current is 1 ampere or more. Up to 0.25 ampere can be handled by the transistor in still, free air. Above this level, a heat sink must be provided. To keep within the maximum power dissipation ratings of the transistor (1.5 watt in free air, 6.25 watts with heat sink), the collector output current under illumination must not exceed 0.25 amp at 6 volts and 125 ma at 12 volts in free air, or 1 amp at 6 volts and 520 ma at 12 volts with a heat sink.

When the photocell is darkened, the only current in the load is the static leakage current ( $I_{co}$ ) of the transistor—0.8 ma at 6 volts and 25°C.

In permanent installations, the battery may be replaced with an ac-operated, low-voltage, high-current dc power supply using a silicon rectifier. —Ted Ladd END

### 50 Years Ago

In Gernsback Publications

#### HUGO GERNSBACK, Founder

Modern Electrics	1908
Wireless Association of America	1908
Electrical Experimenter	1913
Radio News	1919
Science & Invention	1920
Television	1927
Radio-Craft	1929
Short-Wave Craft	1930
Television News	1931

Some larger libraries still have copies of Modern Electrics on file for interested readers.

#### In June, 1911, Modern Electrics

The Rosing Telephot. (This historical article is possibly the first showing the use of a cathode-ray tube in connection with television. Professor Rosing was with the Technical Institute of St. Petersburg, now Leningrad.)  
New Bellini-Tosi Apparatus, by A. C. Marlowe.  
Wireless Interferences and Perturbations, by J. E. Taylor.  
Unique Means to Vary Wave Length.  
Detector Recorders.  
Transmitting Condenser, by J. McClain.

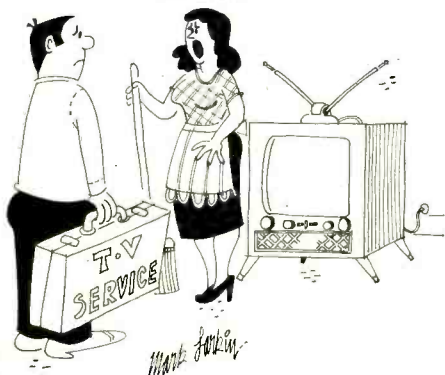

"It acts like the video output stage has heater-cathode leakage."

Ralph  
Woertendyke  
tells

# Why

HE USES

## STANCOR TRANSFORMERS EXCLUSIVELY

"I just finished installing a Stancor replacement transformer in a TV set, and as per usual, it fit perfectly and works perfectly. So thanks for making my job easier by making available these fine exact replacement components.

"I found this transformer replacement by looking it up on the Stancor TV Replacement Guide. This saves me time. This makes me money. Stancor offers a vital service in addition to a good product. So, thank you for this service.

"I have been using Stancor exclusively for the last two years, as obtained through my distributor, Electronics, Inc. of this city. I am glad to buy your transformers, and I just wanted to take a few minutes to say Thank You."



Salina, Kansas  
Independent Service Dealer  
likes the time-saving,  
money-making features

(The above is from an unsolicited letter, quoted with permission, received by Chicago Standard Transformer Corporation from the head of Television Engineering, 225 N. Santa Fe, Salina, Kansas.)

## CHICAGO STANDARD TRANSFORMER CORPORATION

3501 West Addison Street • Chicago 18, Illinois

**MAKE  
MONEY  
IN SPARE  
TIME**

Learn at Home to Fix  
**ELECTRIC  
APPLIANCES**

Tester Furnished—No Extra Charge. Fix toasters, irons, fans, other electric appliances for friends and neighbors. Make money in spare time or build your own full time business. SAVE cash by repairing your own appliances. Enjoy the security of a skill to fall back on during slack periods, seasonal layoffs, when you retire. NRI will train you at home. **MAIL COUPON NOW. Sample Lesson and Catalog FREE.**  
National Radio Institute, Dept. FF1, Wash. 16, D. C.  
Please send me Electrical Appliance sample lesson and catalog FREE (No Salesman Will Call).

Name.....Age.....  
Address.....  
City.....Zone.....State.....

**SPECIAL M7D** STEREO CARTRIDGE  
For Super Stereo Quality \$11.95

Write for our FREE bargain flyer! A real money saver on Hi Fi equipment. Let us quote you on standard items—Most Prices We Can Beat!

**CUTICK ELECTRONICS**

171 Washington St. Tel. Wo 2-5866 N. Y. 7, N. Y.

**A NOTE TO THE HI-FI BUYER**  
AIR MAIL us your requirements for an IMMEDIATE LOWEST PRICE QUOTATION Components, Tapes and Records  
SHIPPED PROMPTLY AT LOWEST PRICES  
**WRITE TODAY FOR FREE CATALOG**  
**AUDIO** 190-R Lexington Ave.  
UNLIMITED New York 16, N. Y.

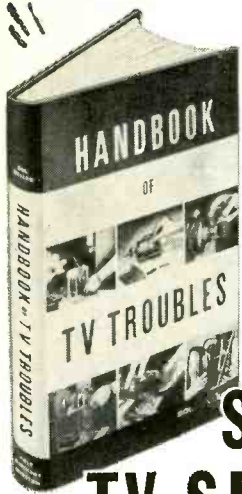

# new

## Master Guide to TIME-SAVING TV SERVICE

A modern manual for fast, "symptomatic" TV trouble analysis and servicing

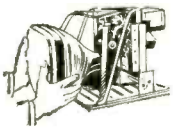

**TAKES THE GUESSWORK OUT OF TELEVISION REPAIR!**

Covers all causes of practically every television receiver trouble including:

- BRIGHTNESS TROUBLES
- CONTRAST TROUBLES
- PICTURE DISTORTION
- UNSATISFACTORY PICTURE DETAIL
- LINE OR BARS IN PICTURE
- SYNCHRONIZATION TROUBLES
- MISSING PICTURE
- SIZE AND CENTERING TROUBLES
- SOUND TROUBLES
- TELEVISION INTERFERENCE ETC.

From beginning to end, this big manual is designed for daily use at the bench as a complete easily understood guide to practically any job on any TV receiver. It isn't a "study" book!

Just turn to the Index. Look up the trouble symptoms, exhibited by the TV you're working on. The HANDBOOK OF TV TROUBLES then tells you exactly what and where to check. Outlines time-saving short cuts. Explains puzzling details. Eliminates guesswork and useless testing. More than 150 test pattern, wave form and circuit illustrations help explain things so clearly you can hardly fail to understand.

## LOOK! LISTEN!

... then Follow This Easy Guide!

Almost regardless of set make or model, this remarkable new 302-page Handbook helps you track down TV troubles from the symptoms they produce in the set itself—screen intermittently dark; "blooming"; abnormal contrast in spots; "snow"; poor detail; sync troubles; sound troubles—and all the many others. Then it explains how to make needed adjustments or replacements.

Printed in large type. Has sturdy, varnished covers for "on the job" use. The TV TROUBLE INDEX helps you find what you want in a jiffy. Throughout, it's the ideal guide for beginners and experienced servicemen alike! Try it for 10 days AT OUR RISK. You be the judge!

## PRACTICE 10 DAYS FREE!

Dept. RE-61, Holt, Rinehart and Winston, Inc. 623900  
Technical Div., 383 Madison Ave.  
New York 17, N. Y.

Send new 302-page HANDBOOK OF TV TROUBLES (708453) for 10-day FREE trial. If I decide to keep book, I will then send you \$7.50 in full payment. If not, I will return book prepaid and owe you nothing. **SAVE!** Send \$7.50 with order and we pay the postage. Same 10-day return privilege with money promptly refunded.

Name.....  
Address.....  
City, Zone, State.....  
**OUTSIDE U.S.A.—No free trial. Price \$8.00, cash with order. 10-day return privilege with money refunded. Above offers expire Jan. 31, 1962.**

# new LITERATURE

Any or all of these catalogs, bulletins, or periodicals are available to you on request direct to the manufacturers, whose addresses are listed at the end of each item. Use your letterhead—do not use postcards. To facilitate identification, mention the issue and page of RADIO-ELECTRONICS on which the item appears. **UNLESS OTHERWISE STATED, ALL ITEMS ARE GRATIS. ALL LITERATURE OFFERS ARE VOID AFTER SIX MONTHS.**

**GUIDE TO CUSTOM STEREO** begins with an informative introduction of questions and answers on the subject of stereo. Booklet, in color, includes ample illustrations of room layouts as well as of stereo components.—H. H. Scott, 111 Powdermill Rd., Maynard, Mass.

**SERVICE BUSINESS ADVERTISING** and tie-in identification is subject of 16-page *Guide to Extra Impact Identification*. Color brochure outlines all channels of advertising and promotion normally

open to service businessmen. It is divided into individual sections for various media, each of which contains actual sample ads for the service technician to use.—PFSS Association, Philco, 2nd and Westmoreland Sts., Philadelphia 40, Pa.

**TRANSISTOR**, the JAN 2N665, studied in *Semiconductor Reliability with Delco Radio* for long-term operating, modulation and storage-life data, short-term operating-life data and environmental data. Its graphical and statistical data are acquired from random-sample evaluation testing.—Delco Radio Div., General Motors Corp., Kokomo, Ind.

**VTVM KIT**, Professional model VTV45, completely described and illustrated in 6-page color *Brochure PK*.—Dept. C, General Techniques Inc., 1270 Broadway, New York 1, N. Y.

**TRANSFORMERS AND CHOKES P-6358**, PM-8423, P-6432, P-6433, P6464, C-2345 and C-2346 presented in single page *Bulletin 586 12-60*.—Chicago Standard Transformer Corp., 3501 W. Addison St., Chicago 18, Ill.

**MINIATURE COMPONENTS**, including panel meters and side indicators, displayed in new 1961 catalog. Four pages, in color, give product descriptions, specifications and drawings.—International Instruments Inc., PO Box 2954, New Haven, Conn.

**COMPONENTS Catalog C-614** contains more than 4,000 items, including more than 1,300 new listings. Descriptions, specifications, drawings, interchangeability guide, alphabetical-numerical index and list-net-price schedule among

## ATLAS "Job Rated" P. A. SPEAKERS



There is an Atlas Speaker Ideally Suited for Every Job

All Atlas P. A. speakers are highly efficient, especially in the voice frequency range, providing the extra "punch" needed to override high level background noise. Most are 100% weatherproof; aluminum and diecast parts are treated with corrosion inhibitors, then finished in "stone hard" baked enamel. The CJ Cobra-Jector horns are constructed of nonresonant, indestructible fiberglass, and HU and TP speaker horns of aluminum, finished in gun-metal grey. The HU and TP speakers are particularly designed for efficient talkback operations. The peaked characteristics within the voice frequencies increase the sensitivity of these speakers as pickup devices.

All HU and CJ speakers are equipped with versatile "Versalock" . . . This rugged, reliable mounting bracket, completely adjustable both horizontally and vertically, provides positive locking in any position.

The DU-12 and DC-5, Atlas' renowned DeCor projectors, are styled to harmonize with any decor, modern or traditional. Send for free catalog to Dept. RE-6

Model	HU-12N	HU-15N	HU-24N	CJ-14N	CJ-30N	CJ-44	TP-15N	TP-24N	DU-12	DC-5
POWER*	7.5 w	25 w	25 w	7.5 w	25 w	60 w	25 w	25 w	7.5 w	6 w
IMPEDANCE**	8 ohm	8 ohm	8 ohm	8 ohm	8 ohm	16 ohms	8 ohm	8 ohm	8 ohm	8 ohm
FREQUENCY C.P.S.	350-10,000	250-10,000	200-10,000	400-10,000	250-10,000	150-9000	250-10,000	200-10,000	400-10,000	120-7000
LENGTH OVERALL	7 1/4 in.	8 3/4 in.	12 in.	8 in.	1 1/4 in.	23" x 13"	16 1/2 in.	23 in.	14 in.	14 in.
BELL DIAMETER	7 1/2 in.	9 3/4 in.	11 1/4 in.	9 1/2" x 5 1/2"	14" x 6"	19 in.	9 3/4 in.	11 1/4 in.	7 in.	7 in.
NET PRICE	\$16.20	\$20.10	\$22.35	\$18.00	\$24.60	\$43.50	\$31.20	\$34.50	\$19.80	\$13.20

\*Input range limited to frequencies above horn cutoff \*\*All models available in 45 ohms at slightly higher prices



TP-15N TP-24N



DC-5  
DU-12

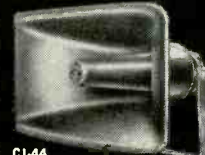

CJ-44

## ATLAS SOUND CORP.

1449 39th Street  
Brooklyn 18, N. Y.

In Canada:  
Atlas Radio Corp., Ltd.,  
Toronto, Ontario

contents of its 44 pages.—Sprague Products Co., 81 Marshall St., North Adams, Mass., 10¢.

**MODEL-TO-PARTS GUIDE** is composed of 4 sections, television, high-fidelity, radio and portable phonograph. Manual lists more than 58,500 parts, each located in its own particular category by model. The 902 separate models of product cover 1955 through 1960. Separate product sections, from 75¢ to \$4, depending on number of pages.—Westinghouse Electric Corp., Box 2278, Pittsburgh 30, Pa.

**FOREIGN-TUBE INTERCHANGEABILITY GUIDE** for 1961 cross-references tube numbers under 3 headings, European, European/American and American. 1,150 tube types are listed in its 24 pages. Available in quantities at no cost to distributors of *Radio-Electronic Master*, or 25¢ single guide.—United Catalog Publishers Inc., 60 Madison Ave., Hempstead, N. Y.

**HST TRANSFORMERS**, their specifications, charted engineering data and test methods are featured in 28-page *Catalog 103*. A quick-reference product index serves as a guide to the cross-referenced and fully illustrated material.—Arco Electronics Inc., Pond Hill Rd. and Community Dr., Great Neck, N. Y.

**ZENER DIODE** selection simplified with new 1-sheet reference chart. Rounds up more than 2,000 devices ranging from 2.4 to 200 volts and from ¼ to 50 watts.—Motorola Semiconductor Products Inc., 1051 Bloomfield Ave., Clifton, N. J.

**DYNAMIC HEADPHONES** for 1961 completely described and priced in 4-page catalog *Stereo-Fones and Dimensional-Fones*. Models offered range from 8 ohms to very high impedance. Catalog includes adapters and replacement parts.—Permoflux Products Co., 4101 San Fernando Rd., Glendale 4, Calif.

**AUDIO AND ELECTRONIC PRODUCTS** described and illustrated in new catalog. Its 8 pages give detailed specifications for each, and lists and describes more than 200 tube types, including a number of European makes.—Sonotone Corp., Elmsford, N. Y. END



"Gee, I hope we get one of those annoying call backs!"

JUNE, 1961

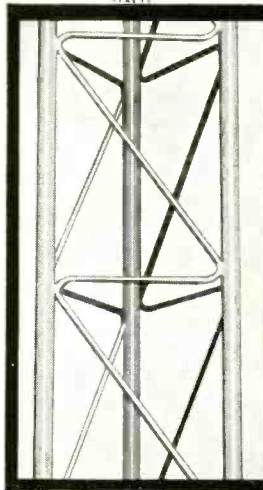
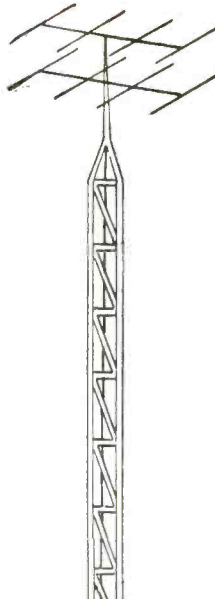

## THE MOST FAMOUS LINE OF TOWERS IN THE WORLD ARE ROHN!

*Here are the features that make them the largest selling and most accepted tower for television, radio, industrial and communications uses:*

- **ZIG-ZAG CONSTRUCTION**—proven zig-zag design means sturdiness and dependability that is truly outstanding. Tower sections are completely assembled and electric welded throughout for maximum strength and greater economy in erection.
- **HOT DIPPED GALVANIZED AFTER FABRICATION**—Entire tower sections are completely zinc coated after fabrication for the finest outer protection possible. Being galvanized after fabrication means no uncoated bolt holes, weld spots or seam to rust. All ROHN Towers last far longer and have less maintenance than competitive towers because of this feature.
- **HIGHEST QUALITY MATERIAL USED**—only highest quality laboratory-certified steel tubing is used (not pipe). Quality steel plus heavy gauges combine to give far greater strength than competitive towers.
- **COMPLETE LINE FOR WHATEVER YOUR NEEDS**—Fully self-supporting towers are available to 170 feet or lower; heavy duty guyed towers available up to 500 feet. Whatever your needs, check ROHN.
- **UNEXCELLED ENGINEERING**—all ROHN Towers are engineered to meet the most rigid requirements as outlined by all major communications equipment manufacturers and electronic industry associations.
- **UNIVERSAL ACCEPTANCE**—Hundreds of thousands of Rohn Towers are in use all over the world. They have withstood the "test of time"—the only true test as to the superiority of a tower. So why settle for less than the BEST? Insist on the largest selling tower in the world—ROHN.

For your needs and for all allied tower accessories, contact your local ROHN salesman or write direct for full information.

SEND THE HANDY COUPON INDICATING YOUR NEEDS

# ROHN

Manufacturing Company  
BOX 2000  
PEORIA, ILLINOIS

ROHN Manufacturing Company  
Box 2000  
Peoria, Illinois

Send me complete literature on the following ROHN Products:

- TV Towers  Amateur Towers  
 Communication Towers  ROHN Accessories

Name \_\_\_\_\_

Firm \_\_\_\_\_

Address \_\_\_\_\_

City \_\_\_\_\_ State \_\_\_\_\_

### SUPER MAGNET SUPER SAVING!

Buy this Little Giant magnet, most powerful made, a sensational bargain! The low price of \$1.95 is less than 50% of what you'd pay for this magnet. Experimenters, hobbyists will find hundreds of uses for this powerful 4 oz. Alnico permanent magnet. LIFTS 5 lbs. EASILY. Limited quantity. Order several today. Measures 1 3/4" x 1 1/2".  
Item No. 86 \$1.50  
Special Bargain (Shp. Chgs. 10c)



### 250 POWER TELESCOPE LENS KIT

Make your own high powered 6 ft. telescope! Kit contains 2" diam., 7 1/2" focal length, ground and polished objective lens and necessary eye pieces. Magnifies 50x to 250x. Full instructions.

ITEM NO. 123  
\$2.95  
(Shp. Chgs. 10c)



### AMAZING BLACK LIGHT

250-watt ultra-violet light source. Makes fluorescent articles glow in the dark. Fits any lamp socket. For experimenting, entertaining, unusual lighting effects.



Shp. wt. 2 lbs.  
ITEM NO. 87 \$2.95  
(P. P. & Hdlg. Chgs. 35c)



### WATTHOUR METER

Loading makes—reconditioned. Ideal for trailer parks. 100-110 volts, 60 cycles, 2-wire A.C. 5 amp. Heavy metal case 8 1/2" x 6 1/4" x 5". Easy to install. Shp. wt. 14 lbs.

ITEM NO. 33  
NOW ONLY \$4.50  
(P.P. & Hdlg. Chgs. \$1.25)

HUDSON SPECIALTIES CO., 160 W. 14th St. Dept. RE 561, New York 7, N.Y.

I am enclosing full remittance for items circled below. (Be sure to include shipping charges.)

87 33 86 123

Name \_\_\_\_\_ Please Print Clearly

Address \_\_\_\_\_

City \_\_\_\_\_ Zone \_\_\_\_\_ State \_\_\_\_\_

# CITIZENS BAND SALE!

Closing out our stock of CB kits. Nationally advertised at \$39.95 up. Complete with power supply, tubes, crystal, cabinet, coils, etc., less mike. Kit sales final. Rush your order today!!

- 110 VOLT CB TRANSCEIVER KITS... \$19.95
- 12 VOLT CB TRANSCEIVER KITS... \$22.95
- 6 VOLT CB TRANSCEIVER KITS... \$22.95

## GROVE BREAKS THE CB ANTENNA PRICE BARRIER!!!

Clearance sale brings you lowest prices in country.

- GROUND PLANE ANTENNA (Reg. Price \$15.95) SALE PRICE \$8.99
- 3-ELEMENT HORIZONTAL BEAM ANTENNA (Reg. \$29.95) SALE PRICE \$11.99
- FIELD STRENGTH METER KIT (fantastically priced!!) SALE PRICE \$6.99
- 11-PC. MOBILE NOISE SUPPRESSION KIT (includes tunable Generator Filter) SALE PRICE \$3.99
- FAMOUS BRAND CERAMIC CB MIKE (Reg. \$11.00) SALE PRICE \$4.95
- FAMOUS MAKE CB XMTG CRYSTALS (Reg. \$3.95) (EACH) SALE PRICE \$1.99  
Lots of 3—\$1.89 each; Lots of 6—\$1.79 each

Check items wanted. Return ad w/check or M.O. include Postage. Excess returned. C.O.D. orders 25% down (Note: Antennas must be shipped railway express or freight)

GROVE ELECTRONIC SUPPLY COMPANY  
4105 W. Belmont Ave., Chicago 41, Ill.

- Rush items checked
- Send free Catalog of Giant CB values

Name..... (please print)  
Address.....  
City..... Zone..... State.....

# GOOD PRICES FOR GOOD PHOTOGRAPHS

154 West 14th St. New York 11, N.Y.

## EICO new Transistor Stereo/Mono 4-track Tape Deck

Model RP 100W Completely assembled, wired and tested with 3 heads, and stereo record and stereo playback preamplifiers.

Model RP 100K Semi-Kit includes transport completely assembled and tested with 3 heads; and control electronics, stereo record, and stereo playback preamplifiers in easy-to-assemble kit form.

Write for full specifications

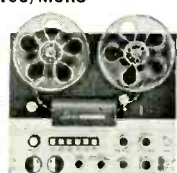

## TAPE STORAGE OR CARRYING CASE

reg. 9.95, now 5.95  
(Heavy wood construction, waterproof vinyl covering. Holds up to 24 tapes.)  
reg. 2.45, now 1.49



(Pressed cardboard, holds 10 tapes or 60 45 rpm records.)

## SAXITONE RECORDING TAPE

\*Oxide guaranteed not to rub off or squeak—or money back. Compare ours with other "Bargain" tape. You'll find it's more than just "price" when you deal with us. We are original pioneers in the tape recorder business and our reputation means everything to us.

600' acetate (plastic), 5"	.75
600' MYLAR 5" reel	.95
900' MYLAR (polyester)	.99
1200' MYLAR, 1/2 mil, 5" reel	1.18
1200' Acetate (plastic), 7"	1.19
1200' MYLAR, 1 1/2 mil. (Strong)	1.68
1800' acetate (plastic), 7"	1.79
1800' MYLAR 1 mil. thick, 7"	1.99
2400' MYLAR, tensilized, 7"	2.69
2400' MYLAR, tensilized, 7"	2.99

Studios, Large Users Even Lower.

TAPE STORAGE CAN Plus Postage FERRO. Unique twist-lock insures dust-free moisture-proof, non-breakable. High impact styrene. Ideal shipping container. reg. 89c now 59c



DYNAMICS "Bookshelf" open end case reg. 1.25, now 89c

25% off SALE 25% off ENTIRE STOCK PRE-RECORDED MUSIC TAPES If we do not have it we'll order it for you

## NORELCO SPEAKERS

DISCONTINUED MODELS: Famous 9777—successor to 9710M twin cone—original list \$9.95, (10-20,000 cycles) usual NET \$7.97. NOW \$1.98; also 3800M, list \$6.00, usual NET \$4.90, now \$4.95 while they last. PLUS POSTAGE. Other sensational speaker reductions on a first come, first served basis. SEND FOR SPEAKER SPECIFICATION SHEET.



SAXITONE TAPE SALES (DIV. OF COMMISSIONED ELECTRONICS, INC.) 1776 Columbia Rd., NW, Washington, D.C.

Answers to

# What's Your EQ?

Here are the answers to last month's questions. We have not been able to print any answers from readers due to time squeeze, but, if any outstanding solutions come in, we will run them next month.

## Photo-relay Circuit

Knowns:

1. Both relays are actuated by a decrease in light.
2. RY1—in 500° circuit—has normally closed contacts.
3. RY2—in 450° circuit—has normally open contacts.
4. When RY1 opens, voltage is removed from the heater and from LM1.

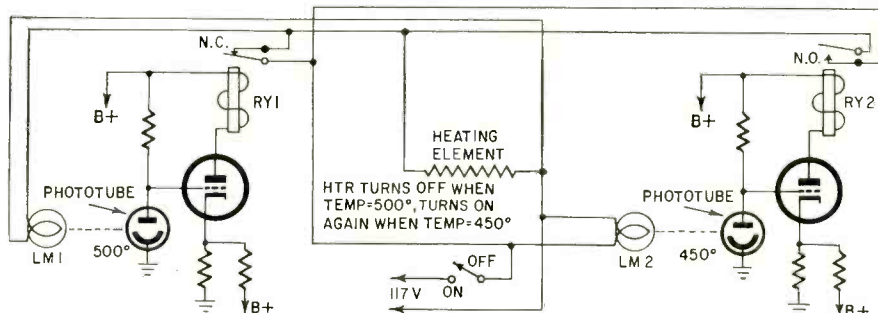
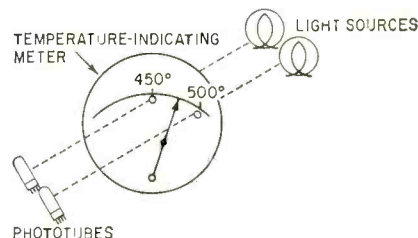

5. When RY2 closes, voltage is applied to the heater and to LM1.

RY1 is blocked. RY1 opens, removing voltage from the heater and LM1.

Operation:

Assume temperature is between 450° and 500°.

1. The heater and LM1 are on.
2. Light falls on both phototubes.
3. When the temperature reaches 500°, light to the phototube controlling

4. The heater and LM1 remain off because RY1 is operated by a decrease in light level.

5. As the temperature reaches 450°, the hole is blocked, RY2 pulls in and the normally open contacts close, applying power to the heater and LM1.

## Service Stinker No. 1

Although voltage measurements and current measurements show everything to be lovely as far as dc is concerned, a scope reading taken across R1 shows something like 300 volts peak-to-peak ripple! The exceedingly low-impedance path to ground provided by the 10- $\mu$ f capacitor causes a tremendous pulse current to flow through the little re-

sistor, burning it out very rapidly. Cause: completely open input filter capacitor in the power supply! Both in fact. The negative connection had opened. This would have been cleared quickly had a scope been used on the B-plus, instead of relying solely on dc voltage measurements.

## Black Box

The black box must obviously contain an intermittent contact—a chopper or vibrator, represented in this case by an ordinary buzzer operated from its own dry-cell power supply. In such a circuit, voltage is that of the supply when the contacts are open and zero when it is closed. Current is, of course, zero when the contacts are open and rises to a value limited only by the resistance of the meters in series and the internal impedance of the source when the contacts close.

But the contacts open and close in such rapid sequence that conventional meters cannot follow the voltage and

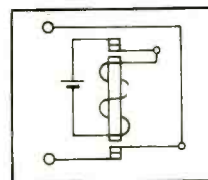

current patterns, so take up positions between zero and the peak values. Since the wattmeter needs both voltage and current to show any indication, and since there is no voltage when there is current and no current when there is voltage, it remains at zero. END

# BUSINESS and PEOPLE

Robert F. Halligan (l.) was elected president of Hallicrafters Co., Chicago. Stanley E. Rendell was elected vice president. Halligan, formerly executive vice president and general manager,



succeeds his father, William J. Halligan, Sr., who continues as chairman of the board and chief executive officer. Rendell was formerly vice president for operations and assistant general manager.

Arde O. Laulainen (l.) joined Radio Shack Corp., Boston, Mass., as vice president in charge of retail sales oper-



ations. He comes from Montgomery Ward. Gaylord Russell joined Radio Shack as director of engineering. He had been with Heath Co. as senior audio engineer.

Hartley Bond (l.) was appointed marketing manager for the New Bedford, Mass., plant of Cornell-Dubilier Electronics Div., Federal Pacific Electric Co., Newark, N.J., in charge of market-



ing capacitors, pulse networks and delay lines and filters. He had been marketing manager for semiconductors and tantalum capacitors. Robert J. Reigel succeeds him in this position. Reigel had been distributor sales manager.

Frank Pyle, Jr., (l.) was appointed vice president, and Robert L. Webster, treasurer, of Utah Radio Products Corp.,



# ELECTRONICS

## Engineering-Technicians



Missile headed for outer space. Courtesy of Space Technology Laboratories, Inc.

U.S. Air Force Photo

Bachelor of Science Degree, 30 Months  
Save Two Years' Time

- Radio-Television Plus Color Technician (12 Months)
- Electronics Technician (12 Months)
- Industrial Electronics Technician (12 Months)
- Electronics Engineering (B.S. Degree)
- Electrical Engineering (B.S. Degree)
- Mechanical Engineering (B.S. Degree)
- Civil Engineering (B.S. Degree)
- Architecture (B.S. Degree)

Heald College ranks FIRST West of the Mississippi in "Who's Who in America"

Approved for Veterans  
DAY AND EVENING CLASSES  
Write for Catalog and Registration Application.  
New Term Starting Soon.

## HEALD'S ENGINEERING COLLEGE

Established 1863  
Van Ness at Post, RE  
San Francisco, Calif.

Your Name .....  
Address .....  
City .....  
State .....

## THE NEW DYNAMIC RAPID TROUBLE SHOOTER

### METREX GENIE

POCKET-SIZED — TRANSISTORIZED  
SIGNAL GENERATOR  
Tunable 50 cy. to 3.3 mc.

7 INSTRUMENTS IN ONE!



Pat. Pend.

FUNCTIONS AS • RF • IF • AUDIO  
VIDEO • PULSE • BAR GENERATOR  
& VOLTAGE CALIBRATOR

Services — RADIO, TV, HI-FI,  
RECORDERS, PHONES AND INTERCOMS

The GENIE has a tunable range of 50 cycles to 3.3 mc. Output variable from zero to 9 volts peak to peak. The uniquely designed circuitry makes possible unusually stable operation and extremely low battery drain. The rugged diecast housing insures extreme durability and perfect shielding. 2 3/4" x 3 1/2" x 2" size is ideal for shop, lab, and field use.

**1495**  
less  
Batt.

WRITE TODAY FOR  
FREE TROUBLE  
SHOOTING  
GUIDE

**METREX** 519 HENDRIX ST., BKLYN 7, N. Y.

## NEW! "Side Arm" Screw Driver by

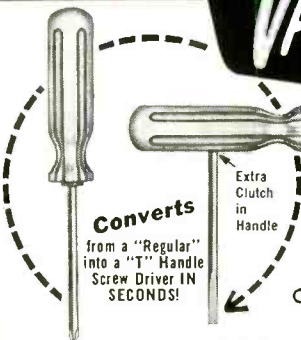

2 interchangeable blades...  
1/4" regular and No. 2 Phillips

A \$4.00 Value  
ONLY **\$2.98** net

## No More "Fishing Around" For The Right Screw Driver

Everyone has wanted a high torque "T" handle screw driver... and VACO's "Side Arm" design now gives you the "T" handle plus regular... in ONE unit. The FREE BONUS gives you a complete fishing kit in addition... at no extra cost.

See Your Parts Jobber

"Handi Angler" FREE BONUS Includes:  
Bobber Hook Sinker Reel Fishing Line  
Regular \$1.00 Value

**VACO PRODUCTS COMPANY, 317 E. Ontario St., Chicago 11, Illinois**  
in Canada: Vaco-Lynn Products Co., Ltd., Montreal 1, Quebec

# SCHOOL DIRECTORY

Huntington, Ind. Pyle was formerly general manager and Webster assistant treasurer.

William W. Garstang is the new manager, special products, for the Centralab Div. of Globe-Union, Inc., Milwaukee, Wis. He comes to the company from the Electronics Div. of Allen-Bradley, where he had been chief engineer for 7 years. Prior to that he was with Raytheon, P. R. Mallory and other electronic companies.



John J. Pacconi, Jr., Audio Empire, Garden City, N.Y., was named national field sales manager. He was formerly district sales manager for Glaser-Steers Corp.



Douglas Battin joined American Microphone Manufacturing Co., Rockford, Ill., as sales manager. He comes to the company from another microphone manufacturer where he was distributor sales manager.



Sencore, Inc., was officially selected as the new name of Service Instruments Corp., Addison, Ill., at the company's



annual sales meeting. The company's representatives are shown at a technical refresher course given at the company's new plant during the meeting.

Perma-Power Co., Chicago, is offering an assembled tool kit free, for a limited time, with the purchase of 12 Vu-Brites.



Sarkes Tarzian Magnetic Tape Div., Bloomington, Ind., is using a new Six-



RADIO-ELECTRONICS

**ELECTRONICS**

**PREPARE FOR A GOOD JOB!**  
BROADCAST ENGINEER  
RADIO SERVICING AUTOMATION

TELEVISION SERVICING  
BLACK & WHITE—COLOR

APPROVED FOR VETERANS AND SURVIVORS  
OF VETERANS  
BUILDING AIR CONDITIONED  
SEND FOR FREE LITERATURE

**BALTIMORE TECHNICAL INSTITUTE**  
1425 EUTAW PLACE, BALTIMORE 17, MD.

**Study in the "Valley of the Sun"**  
**ELECTRONIC ENGINEERING  
TECHNOLOGY**

College-level resident schooling  
Veteran-approved. Catalog on request

**Middleton Institute of Electronics**  
2937 E. McDowell Rd.  
PHOENIX  
ARIZONA

**SCIENCE  
ENGINEERING**

B.S. Degree—36 mos. • B.E. Degree—27 mos.  
Accelerated year-round program: Aero., Chem., Civil,  
Elec., Mech., Metal., Math., Phys., Modest rate.  
Earn board. New classes start June, July, Sept., Jan., Mar.  
Catalog: 1561 E. Washington Blvd., Fort Wayne 2, Ind.

**INDIANA TECHNICAL COLLEGE**

**MATHEMATICS MADE EASY**

by new step-by-step home study method. Courses from elementary to advanced level. Fees as low as \$10. Diploma awarded. Free booklet by Prof. Allcut, P. Eng., gives complete details. Write today to **CANADIAN INSTITUTE OF SCIENCE & TECHNOLOGY LTD.**, 412 5th St. N.W., Washington, D.C.

**LEARN**

LEARN  
RADAR MICROWAVES  
COMPUTERS—TRANSMITTERS  
CODE • TV • RADIO

Phila. Wireless Technical Inst.  
1533 Pine St., Philadelphia 2, Pa.  
A Non-Profit Corp.  
Founded in 1908  
Write for Free Catalog to Dept. RE-5  
Classes now forming

**LEARN**  
**TRANSISTOR, COMPUTER OR  
RADAR ELECTRONICS  
AT HOME!**

Prepare now for a profitable career in one of these growing fields. Learn theory and practical application of all makes and types with proven home study courses from the Philco Technological Center.

For FREE information write:

**PHILCO**  
**TECHNOLOGICAL CENTER**  
P.O. Box 4730, Dept. R-2, Philadelphia 34, Pa.

**ENGINEERING COURSES**

E.E.  
Option Electronics or Power  
Mechanical, Civil & Physics  
Also in Liberal Arts  
presented through  
**HOME STUDY**  
Resident Classes Also  
Available if Desired  
Specify course desired.

**PACIFIC INTERNATIONAL  
COLLEGE OF ARTS  
& SCIENCES**

Primarily a correspondence school

5719-M Santa Monica Blvd. Hollywood 38, Calif.

## FREE! | ELECTRONICS CAREER KIT

If you're interested in breaking into a good-paying job in Radio-TV-Electronics, I.C.S. will send you absolutely free a famous Career Kit with 3 famous booklets that have helped thousands of others—just like yourself—on the road to real success. Includes:

- 1 "HOW TO SUCCEED" Career Guide—36-page gold mine of career tips and information.
- 2 "JOB CATALOG" of opportunities in your field of interest.
- 3 "SAMPLE LESSON" (math) to demonstrate the famous I.C.S. method.

Send today for your free I.C.S. Career Kit with these 3 famous booklets. There's no obligation. This may be the big break you've been waiting for. Mark and mail the coupon today.

**INTERNATIONAL CORRESPONDENCE SCHOOLS**

Dept. 37087E Scranton 16, Penna.

Please send free Career Kit with 3 famous booklets

General Electronics  Radio-TV Serv'g  Practical Electrician  
 Industrial Electronics  Sound Equipmt. Serv'g  Profess'l Eng. (Elec.)  
 Radio-TV Eng'g  Electrical Eng'g  Electrical Drafting  
 Electronic Servicing  Electrical Tech.  Other

Name \_\_\_\_\_ Age \_\_\_\_\_  
 Address \_\_\_\_\_  
 City \_\_\_\_\_ State \_\_\_\_\_



Pac mailer for its magnetic recording tape. Each reel is individually packaged.

Switchcraft, Inc., Chicago, celebrates its 15th anniversary this year. F. O. Dumke, secretary-treasurer; Wilfred Larson, president, and W. E. Dumke,



vice president, engineering (left to right), are shown at the official celebration.

Jensen Industries, Forest Park, Ill., designed a new merchandiser display for its needles. It may be used as a wall hanger, counter display or as a book to stock merchandise under the counter.

**Obituary**

Irving Sarnoff, a pioneer in radio sales and a brother of Brig. Gen. David Sarnoff, chairman of the board of RCA, died at the age of 60 in New York City. He was executive vice president of Bruno-New York, Inc., distributor of RCA Victor radios, TV sets and other electrical equipment. END

**Edison in Hall of Fame**

Thomas Alva Edison was one of three persons chosen to be enshrined in the Hall of Fame for Great Americans in the 1960 election. Elections to the Hall of Fame are held every five years, and a person must have been dead for at least 25 years to be selected.

The 1960 Hall of Fame ballot contained the names of 242 persons who had contributed to the nation's history or culture. They were placed in nomination by the public during the past year. The College of Electors, which includes prominent persons from each of the 50 states, made the final selections. A total of 142 electors voted. A majority, or 72 votes, was required for election.

Edison, known in the electrical field as the inventor of the first commercially practical incandescent electric lamp and many other electrical devices, and in the electronic field as discoverer of the Edison effect and patentee of an early electrostatic induction wireless telegraph, received 108 votes. Henry David Thoreau, poet, essayist, and philosopher, had 83 and Edward Alexander MacDowell, composer and music educator, had 72.

The selectees are enshrined in bronze busts in the open-air colonnade of the Hall of Fame, which is located on high ground on the University Heights (Bronx) campus of New York University. The shrine overlooks the Harlem and Hudson River valleys and the New Jersey Palisades.

# School Directory

## LEARN ELECTRONIC ORGAN SERVICING

This new, high paying profession can now be learned easily in your spare time.

- ★ Complete Training — All Makes and Models
- ★ Scientific Teaching Aids Make Learning Easy
- ★ No Prior Knowledge of Electronics Necessary

**GET FULL DETAILS ON THIS AMAZING COURSE**

**WRITE FOR FREE BOOKLET**

**NILES BRYANT SCHOOL**

Dept. L - 3731 Stockton Blvd.  
Sacramento 20, California

## twenty to one dividend . . .

that's the return you can receive from your investment in your college education in engineering or business. Faster advancement, too. Important firms like Tri-State College graduates return regularly to our campus to interview seniors. Become an Electronics Engineer. Qualify faster here.

### Bachelor of Science Degree in 27 Months

in Electrical (Electronics or Power major), Mechanical, Chemical, Aeronautical, Civil Engineering. IN 36 MONTHS B.S. in Business Administration (General Business, Accounting, Airline Transport Management majors). For earnest, capable, mature students. Small classes. More professional class hours. Beautiful campus. Well-equipped labs, modernized buildings, new dorms. Year-round operation. Enter Sept., Jan., Mar., June. Founded 1881. Write J. G. McCarthy, Director Admissions, for Catalog and "Your Career in Engineering and Commerce" Book.

**TRI-STATE COLLEGE** 2461 College Ave. Angola, Indiana

## ENGINEERING EDUCATION for the Space Age

NORTHROP INSTITUTE of Technology is a privately endowed, nonprofit college of engineering offering a complete Bachelor of Science Degree Program and TWO-YEAR accredited technical institute curricula. Students from 50 states, many foreign countries. Outstandingly successful graduates employed in aeronautics, electronics and space technology. Write today for catalog—no obligation.

NORTHROP INSTITUTE OF TECHNOLOGY  
1181 West Arbor Vitae Street, Inglewood 1, California

## GET INTO ELECTRONICS

V.T.I. training leads to success as technicians, field engineers, specialists in communications, guided missiles, computers, radar and automation. Basic and advanced courses in theory and laboratory. Assoc. degree in electronics in 29 mos., B.S. in electronic engineering obtainable. ECPD accredited, G.I. approved. Graduates in all branches of electronics with major companies. Start September, February. Dorms, campus. High School graduate or equivalent. Catalog.

**VALPARAISO TECHNICAL INSTITUTE**

Dept. C Valparaiso, Indiana

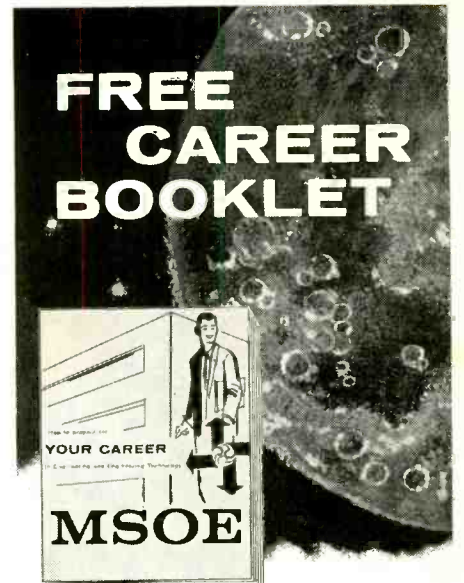

to guide you to a successful future in **ELECTRONICS RADIO-TV COMPUTERS ELECTRICAL ENGINEERING**

This interesting pictorial booklet tells you how you can prepare for a dynamic career as an Electrical Engineer or Engineering Technician in many exciting, growing fields:

- MISSILES • RADAR • RESEARCH
- ELECTRICAL POWER • ROCKETRY
- AUTOMATION • AVIONICS
- SALES • DEVELOPMENT

Get all the facts about job opportunities, length of study, courses offered, degrees you can earn, scholarships, part-time work — as well as pictures of the Milwaukee School of Engineering's educational and recreational facilities. No obligation — it's yours free.

## MILWAUKEE SCHOOL OF ENGINEERING

### MAIL COUPON TODAY!

MILWAUKEE SCHOOL OF ENGINEERING  
Dept. RE-661, 1025 N. Milwaukee St. MS-113  
Milwaukee, Wisconsin

Please send FREE "Your Career" booklet I'm interested in  Electronics  Radio-TV  Computers  Electrical Engineering  Mechanical Engineering (PLEASE PRINT)

Name \_\_\_\_\_ Age \_\_\_\_\_

Address \_\_\_\_\_

City \_\_\_\_\_ Zone \_\_\_\_\_ State \_\_\_\_\_

I'm eligible for veterans education benefits.

Discharge date \_\_\_\_\_

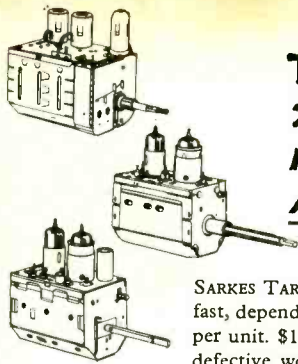

## TUNERS REPAIRED \$8.50

### 24-Hour Service 6-Month Warranty

**Repair Charge includes**  
**ALL Replacement Parts**

SARKES TARZIAN, INC., pioneer in the Tuner Manufacturing business, offers fast, dependable, factory repair service on *all* makes and models. Cost—\$8.50 per unit. \$15 for UV combinations. Now offering 6-month warranty against defective workmanship and parts failure due to normal usage. Tuners repaired on approved, open accounts. Replacements available at low cost on tuners beyond practical repair.

Tarzian-made tuners easily identified by this stamping. When inquiring about service or replacements for other than Tarzian-made tuners, always give tube complement . . . shaft length . . . filament voltage . . . series or shunt heater . . . IF frequency, chassis identification. And, allow a little more time for service on these tuners. Use this address for fast, factory repair service:



# SARKES TARZIAN INC

east hillside drive  
bloomington, indiana  
edison 2-7251

SERVICE MANAGER • TUNER DIVISION DEPT. C

Mfgs. of Tuners, Semiconductors, Air Trimmers, FM Radios, Audio Tape, and Broadcast Equipment

# new BOOKS

**R/C PRIMER—Radio Control for All, by Howard G. McEntee. Kalmbach Publishing Co., 1027 N. Seventh St., Milwaukee, Wis. 8 x 11 in. 66 pp. \$2.**

Aimed at the beginner, the book starts with information on obtaining a Citizens-band license, describes and explains the various control devices, components and linkages, then tells the reader how to install his equipment. The electronics of the equipment is covered only generally, the reader being advised to build his receivers and transmitters from kits or buy them complete. Field testing and maintenance are given considerable space. The book is well printed on excellent paper, and the interesting illustrations are superlative, both as to line drawings and photographs.—*FS*

**TRANSISTOR CIRCUIT ANALYSIS AND DESIGN, by Franklin C. Fitchen. D. Van Nostrand Co., Inc., 120 Alexander St., Princeton, N. J. 6 x 9 in. 356 pp. \$9.**

This text is based on a one-semester course for electrical engineering students at junior or senior level. No prior knowledge of transistors is assumed. The first chapters are a good introduction to transistor physics and circuits. Thereafter the book goes into the design of amplifiers, receivers, multivibrators, etc. Attention is focused on the hybrid equivalent circuit, and hybrid parameters are used often.

Complete design examples are worked out throughout the text. Problems and references are found after most chapters.—*IQ*

**TROCKEN-BATTERIEN (Dry Batteries), by Richard Huber. Verlag R. Oldenburg, Rosenheimer Strasse 145, Munich, Germany. 6 x 8 1/2 inches. 111 pp. DM 5.80.**

A very complete little treatise in German on Leclanché cells, covering fundamentals and theory, raw materials, fabrication, and special types. Also includes a chapter on cells with an electrochemical composition differing from the Leclanché (magnesium, copper or mercury oxide, etc.). A chapter of technical tips and tables wraps up the work.—*FS*

**DIGITAL COMPUTER FUNDAMENTALS, by Thomas C. Bartee. McGraw-Hill Book Co. Inc., 330 W. 42 St., New York 36, N. Y. 9 x 6 in. 342 pp. \$6.50.**

The book starts with a discussion of the difference between desk calculators and computers and carries on through the use of digital computers in business, science and control systems. It has a chapter on programming, and further chapters on number systems, basic logical circuits, logical designs, arithmetic, memory and control elements. The language is simple and easily understood by persons outside the computer field. Illustration tends toward the sparse. END

RADIO-ELECTRONICS

**OUT OF SPACE?**  
You bet we'd be . . . if we were to tell you all about AUDION's "Out of this World Hi Fi Values."

Write for free Catalog

**audiON**  
25-E Oxford Road  
Massapequa, New York

**PLAY UP**

**THOSE NEEDLES!**

Duotone needles, of course . . . tipped with genuine diamonds, sapphires or osmium. Most people forget to change their styli or don't know how to change them. Why not suggest a Duotone diamond needle replacement for every phonograph that comes into your shop? It's the stylus with the whole diamond tip that's handset and hand polished. Your customers will appreciate the service and you'll appreciate the increase in business.

Write for Free 1961 Duotone Needle Wall Chart and see DUOTONE Distributor.

**DUOTONE**  
COMPANY, INC. KEYPORT, N. J.



if you purchase **TUBES & SPECIALIZED ELECTRONIC COMPONENTS . . . THE NEW 1961 BARRY GREENSHEET\* IS A MUST!**

\* A complete catalog of specialized industrial Electronic TUBES and COMPONENTS . . . Featuring Barry Electronics savings to Industry, Servicemen and Experimenters.

We have thousands of tube types in stock. First Quality at Sensible Prices. Buy with confidence.

**SPECIALS—RCA Herm. s/d XFRMS:** Pri: 115 VAC @ 60 CPS. Sec: 1290 VCT @ 390 Ma. \$4.95. Pri: 115 VAC @ 60 CPS. Sec: 905 VCT @ 360 Ma. \$3.95.

**RC221 FREQ. METER:** w/ internal modulation & original calibration book. Lab tested. Excel Cond. \$99.

**Merit Choke:** 10 Hy. @ 250 Ma. Merit C-3182. \$2.95.

**RCA PRECISION 500 KC CRYSTAL OSCILLATOR.** Accuracy plus or minus 0.0012%. Contains Precision 500 KC crystal. PMS Labs Crystal oven, 5840 sub-miniature tube. Hermetically sealed nickel plated rectangular tube. Mounts in standard 7 pin miniature socket. case. Requires 6.3 VAC or DC. 75 to 100 V.D.C. With schematic. RCA Type A883R300-1. Size: 4-1/2" H x 1-7/16" W x 1-1/4" D. Wt: 1 lb. Cat. # 4-500 CRV. (Orig. Govt. Cost: \$172.00.) VERY SPECIAL ONLY \$3.75.



**Compact 125 Watt Modulation Xfmr:** Pri: 10,000 Ohms Plate to Plate. Sec: 4350 Ohms. Has screen winding. 3800 Ohms. Open frame, epoxy impregnated. Winding insulation to ground, 5000 Volts Peak. Dimensions: 3 1/4" H x 3 1/2" W x 3 1/4" D. Wt.: 3 lbs. \$6.95.

**Plate Transformer:** Pri: 115 VAC @ 60 CPS. with taps. Sec: 3200 VCT @ approx. 300 Ma. Overall Dimensions: 8 1/2" H x 4 5/8" W x 8" D. Wt.: 27 lbs. Mfd. for RCA. \$10.50. (FOB: premises NYC).

**C.D. 4 Mfd. @ 4000 VDC Oil Capacitor:** \$9.95 each. (3 for \$27.00). (FOB: premises NYC).

**UCS Jennings Vacuum Variable Capacitors:** 10 to 300 Mmfd. @ 10 KV. (Less tuning shaft, otherwise COMPLETE.) Very special @ \$49.00.

\*All items starred are prepaid to you FOB destination (in Continental USA), unless where otherwise stated.

Send money order, or check with order

Prove these values to yourself! Complete and mail the coupon below for your copy of the "Greensheet. We'll also purchase your equipment and unused tubes. Send details: BARRY ELECTRONICS CORP. 512 Broadway, New York 12, N.Y. Dept. RE-6.

Please send me a copy of the new 1961 "Greensheet and add my name to your mailing list. (RE-6)

Name..... Title  
Company.....  
Address.....  
City..... State

# NOW! FAST ONE DAY SERVICE BRAND NEW RADIO & TV TUBES

## RAD-TEL'S FIRST QUALITY TUBES SAVE up to 75% ONE FULL YEAR GUARANTEE



### SERVICEMEN:

BUY DIRECT FROM RAD-TEL! YOU'LL SAVE PLENTY. YOUR ORDER SHIPPED WITHIN 24 HOURS AFTER RECEIVING AND PROCESSING. RAD-TEL SELLS ONLY BRAND NEW TUBES, NOT USED.

### 1st TIME OFFERED

NOW! RAD-TEL'S "SET TESTED" TRANSISTORS ...  
AT FABULOUS LOW PRICES

A Rad-Tel "general purpose transistor" for each class. Similar to 100's specified in many projects. All transistors are grouped into 4 general classes:

THE SIGN OF  
RAD-TEL'S  
RELIABILITY

LOW POWER AF TYPE  
DRIVER AND OUTPUT



39¢ ea.

LOW POWER RF  
MIXER AND IF



49¢ ea.

79¢  
ea.

HI POWER AF UNITS

CAR RADIO TYPE  
POWER OUTPUT



POWER SUPPLY TYPE



HI POWER \$1.39  
ea.

SPECIAL PURPOSE

TETRODES, ETC.

(Not available at this time)

YOU CAN SUBSTITUTE AND replace with Rad-Tel transistors when working with transistor projects. Transistor substitutions are based on "similar operating characteristics." All Rad-Tel transistors have expensive features, broad tolerances and are tested in AM radio, as radio frequency converter at 1.5 KC and 450 KC intermediate frequency, AF as audio frequency driver. You're safe building numerous projects when you use Rad-Tel's "set tested" transistors. Each Rad-Tel Transistor is fully tested and guaranteed to give sound operating performance without confusing you with COMPLICATED NUMBERS AND CHARACTERISTICS. Here are just a few suggested transistor projects:

Solar Powered Radio,  
Shirt Pocket Radio,  
Carrier Power Receiver,  
Sine, Square-Wave Generator,  
Transistor Preamp for VTVM,  
Regulated Power Supply,  
Meter Sensitivity Multiplier,  
Oscillator Audio & RF  
Electronic Counters.  
(Please note: Most projects,  
including diagrams, are  
appearing in current  
magazines. We don't  
have diagrams.)

59¢  
ea.

LOTS OF 5

RAD-TEL'S  
SELECTED  
KITS ...

UNBELIEVABLY  
LOW PRICED!  
WHILE THEY  
LAST!

79¢  
ea.

- 50 ASST'D TIE LUGS, NO. 1
- 10 ASST'D F.P. CONDENSERS, NO. 6
- 50 ASST'D RADIO KNOBS, NO. 8
- 15 ASST'D T.V. COILS, NO. 13
- 20 ASST'D MOLDING SOCKETS, NO. 5
- 50 ASST'D BRACKETS & HARDWARE, NO. 17
- 15 SETS ASST'D CONNECTORS, NO. 15
- 10 ASST'D T.V. SLUG TUNED COILS, NO. 25
- 10 ASST'D VOLUME CONTROLS, LG & SH SHAFT, NO. 2
- 8 ASST'D T.V. CONTROLS, SHORT SHAFT, NO. 21
- 8 ASST'D VOLUME CONTROLS, LONG SHAFT, NO. 22
- 10 ASST'D SWITCHES, DOUBLES, LONG & SHORT SHAFT, NO. 23
- 10 ASST'D T.V. PEAKING COILS, NO. 24

- 25 ASST'D TRIMMERS, NO. 7
- 10 ASST'D TUBE SHIELDS, NO. 26
- 1 LB. PROX. NUTS & BOLTS, NO. 20
- 4 ASST'D SOUND COILS, NO. 18
- 20 ASST'D HI-WATT RESISTORS, NO. 3
- 7 ASST'D HORIZONTAL COILS, NO. 13
- 15 ASST'D BINDING POST TERMINALS, NO. 16

RAD-TEL TUBE CO. NOT  
AFFILIATED WITH ANY  
OTHER MAIL ORDER  
TUBE COMPANY

SEND FOR FREE TROUBLE SHOOTER  
GUIDE AND NEW TUBE & PARTS CATALOG

# RAD-TEL TUBE CO.

DEPT. REG61 55 CHAMBERS STREET, NEWARK 5, N. J.

TERMS: 25% deposit must accompany all orders, balance COD. Orders under \$5: add \$1 handling charge plus postage. Orders over \$5: plus postage. Approx. 8 tubes per 1 lb. Subject to prior sale. Prices subject to change. No COD's outside continental USA.

Qty.	Type	Price	Qty.	Type	Price	Qty.	Type	Price
	QZ4M	.79		6AX7	.64		12AF6	.49
	1AX2	.62		6BA6	.50		12AJ6	.46
	1B3GT	.79		6BC5	.61		12AL5	.45
	1DN5	.55		6BC7	.94		12AL8	.95
	1G3	.79		6BC8	.97		12AQ5	.52
	1J3	.79		6BD6	.51		12AT6	.43
	1K3	.79		6BE6	.55		12AT7	.76
	1LN5	.59		6BF6	.44		12AU6	.50
	1R5	.62		6BG6	1.66		12AU7	.61
	1S5	.51		6BH6	.65		12AV5	.97
	1T4	.58		6BH8	.87		12AV6	.41
	1U4	.57		6BJ6	.62		12AV7	.75
	1U5	.50		6BK7	.85		12AX4	.67
	1X2B	.82		6BL7	1.00		12AX7	.63
	2AF4	.96		6BN4	.57		12AZ7	.86
	3AL5	.42		6BN6	.74		12B4	.63
	3AU6	.51		6BQ5	.65		12BA6	.50
	3AV6	.41		6BQ6GT	1.05		12BD6	.50
	3BA6	.51		6BQ7	1.00		12BE6	.53
	3BC5	.54		6BR8	.78		12BF6	.44
	3BE6	.52		6BU8	.70		12BH7	.77
	3BN6	.76		6BY6	.54		12BL6	.56
	3BU8	.78		6BZ6	.55		12BQ6	1.06
	3BY6	.55		6BZ7	1.01		12BY7	.77
	3BZ6	.55		6C4	.43		12BZ7	.75
	3CB6	.54		6CB6	.55		12C5	.56
	3CF6	.60		6CD6	1.42		12CN5	.56
	3CS6	.52		6CF6	.64		12CR6	.54
	3DK6	.60		6CG7	.61		12CU5	.58
	3DT6	.50		6CG8	.77		12CU6	1.06
	3Q5	.80		6CM7	.66		12CX6	.54
	3S4	.61		6CN7	.65		12DB5	.69
	3V4	.58		6CR6	.51		12DE8	.75
	4BC8	.96		6CS6	.57		12DL8	.85
EACH TUBE INDIVIDUALLY & ATTRACTIVELY BOXED								
	4BN6	.75		6CJ5	.58		12DM7	.67
	4BQ7	1.01		6CU6	1.08		12DO6	1.04
	4BS8	.98		6CY7	.71		12DS7	.79
	4BU8	.71		6DA4	.68		12DZ6	.56
	4BZ6	.58		6DB5	.69		12EL6	.50
	4BZ7	.96		6DE6	.58		12EG6	.54
	4CS6	.61		6DG6	.59		12EZ6	.53
	4DE6	.62		6DQ6	1.10		12F8	.66
	4DK6	.60		6DT5	.76		12FM6	.45
	4DT6	.55		6DT6	.53		12K5	.65
	5AM8	.79		6EJ8	.79		12SA7M	.92
	5AN8	.86		6EA8	.79		12SK7GT	.74
	5AQ5	.52		6H6GT	.58		12SN7	.67
	5AT8	.80		6J5GT	.51		12SQ7M	.78
	5BK7A	.82		6J6	.67		12U7	.62
	5BQ7	.97		6K6	.63		12V6GT	.53
	5BR8	.79		6S4	.51		12W6	.69
	5CG8	.76		6SA7GT	.76		12X4	.38
	5CL8	.76		6SK7	.74		17AX4	.67
	5EA8	.80		6SL7	.80		17BQ6	1.09
	5EU8	.80		6SN7	.65		17C5	.58
	5J6	.68		6SQ7	.73		17CA5	.62
	5T8	.81		6T4	.99		17D4	.69
	5U4	.60		6U8	.83		17DQ6	1.06
	5U8	.81		6V6GT	.54		17L6	.58
	5V6	.56		6W4	.60		17W6	.70
	5X8	.78		6W6	.71		19AU4	.83
	5Y3	.46		6X4	.39		19BG6	1.39
	6AB4	.46		6X5GT	.53		19T8	.80
	6AC7	.96		6X8	.80		21EX6	1.49
	6AF3	.73		7AU7	.61		25BQ6	1.11
	6AF4	.97		7A8	.68		25C5	.53
	6AG5	.68		7B6	.69		25CA5	.59
	6AH6	.99		7Y4	.69		25CD6	1.44
	6AK5	.95		8AU8	.83		25CUG	1.11
	6AL5	.47		8AW8	.93		25DN6	1.42
	6AM8	.78		8BQ5	.60		25EH5	.55
	6AQ5	.53		8CG7	.62		25L6	.57
	6AR5	.55		8CM7	.68		25W4	.68
	6AS5	.60		8CN7	.97		25Z6	.66
	6AT6	.43		8CX8	.93		35C5	.51
	6AT8	.79		8EB8	.94		35L6	.57
	6AU4	.82		11CY7	.75		35W4	.42
	6AD6	.52		12A4	.60		35Z5GT	.60
	6AU7	.61		12AB5	.55		50B5	.60
	6AU8	.87		12AC6	.49		50C5	.53
	6AV6	.41		12AD6	.57		50DC4	.37
	6AW8	.90		12AE6	.43		50EH5	.55
	6AX4	.66		12AF3	.73		50L6	.61
							117Z3	.61



World's Only 'Portable Recording Studio...'  
the all-in-one

# Norelco®

## CONTINENTAL '400'

### 4-Track Stereo Tape Recorder



A recording studio in a suitcase — that's how Norelco '400' owners describe this most advanced (and most popular) self-contained stereo tape recorder. **VERSATILITY:** 4-track stereo recording and playback, as well as 4-track monophonic recording and playback, at any of its 3 speeds. **FREQUENCY RESPONSE:** at 7½ ips, 50-18,000 cps; at 3¾ ips, 50-14,000 cps; at 1½ ips, 60-7000 cps (yes, its response at 3¾ ips is actually equal to or wider than the response of most other machines at 7½ ips)! **PROFESSIONAL EXTRAS** (at no extra cost): mixing, monitoring, sound-on-sound facilities and the Norelco stereo dynamic microphone. **SIGNAL-TO-NOISE RATIO:** 48 db or better. **WOW AND FLUTTER:** less than .15% at 7½ ips. **CROSSTALK:** 55 db. **HEAD GAP:** .00012". **AUDIO FACILITIES:** completely self-contained, including dual recording and playback pre-amplifiers, dual power amplifiers and two Norelco wide-range, stereo-matched speakers (one in the detachable lid). For complete specifications, write to Norelco. In the meantime, see and hear the '400'. The recording studio you can carry is now available for immediate delivery.

High Fidelity Products Division

**NORTH AMERICAN PHILIPS COMPANY, INC.** • 230 Duffy Avenue, Hicksville, L.I., N.Y.



## TV TUNER OVERHAUL

ALL MAKES  
ONE PRICE  
**\$9.95**

**VHF TUNERS • UHF TUNERS • UV Combinations\***

Castle overhaul charge includes all labor and minor parts and written 90 day warranty. Tubes and major parts are extra at net prices. Tuner to be overhauled should be shipped complete; include tubes, shield cover and any damaged parts. Write down model number and state complaint. Pack well and insure.

Castle, pioneers of TV Tuner overhauling, assure the best service available. Remember, Castle has a decade of experience and overhauling tuners is our only business.

\*UV combination tuner must be of one piece construction. Separate UHF and VHF tuners must be dismantled and the defective unit only sent in.

**SAME DAY SERVICE!**  
On Popular Types  
48 Hours most others

*Castle*

**TV TUNER SERVICE, INC.**

653 Palisade Avenue • Cliffside Park, New Jersey

5710 N. Western Ave., Chicago 45, Ill. In Canada: 136 Main St., Toronto 13, Ontario

## ADVERTISING INDEX

Radio-Electronics does not assume responsibility for any errors appearing in the index below.

JUNE 1961

Advertiser	Page No.
Aero Electronic Products Co.	8
Airex Radio Corp.	97
Allied Radio Corp.	19, 92
Almo Radio Co.	97
Amphenol-Borg Electronics Corp.	18
Atlas Sound Corp.	102
Audio Unlimited	121
Audion	108
B & K Manufacturing Co.	9, 71
Barry Electronics Corp.	108
Bell Telephone Labs.	20
Blonder-Tongue Labs.	94
British Industries Corp. (Multicore)	95
Brooks Radio & Television Corp.	87
Capitol Radio Engineering Institute	15
Carlson Studios	92
Castle Television Tuner Service Inc.	110
Center Industrial Electronics	99
Centralab Div. of Globe Union	98
Chicago Standard Transformer Corp.	101
CLASSIFIED ADS	96
Cleveland Institute of Electronics	11
Colordaptor	95
Commissioned Electronics Co.	104
Coyne Electrical School	93
Cutick Electronics	101
Delco Radio Div. of General Motors	85
DeVry Technical Institute	7
Dressner	71
Duotone Co. Inc.	108
Electro-Voice Inc.	69
Electronic Chemical Corp.	95
Electronic Instrument Corp. (EICO)	26
Electronic Measurement Corp.	92
Electronic Publishing Co.	99
Gernsback Library Inc.	100
Grantham School of Electronics	17
Grove Electronic Supply Co.	104
Heald Engineering College	105
Heath Co.	62-63
Holt, Rinehart & Winston Inc.	102
Hudson Specialties Co.	103
Indiana Technical College	99
JFD Electronics	65
Key Electronics Co.	71
Lafayette Radio-Electronics Corp.	25
Lektron Inc.	89
Mercury Electronics Corp.	16
Metrix	105
Moss Electronics Inc.	74-77
National Radio Institute	3, 101
National Technical Schools	5
North American Philips Co., Inc.	110
Perma-Power Co.	89
Pierre Tube Outlet	92
Progressive Ed-U-Kits Inc.	86
Pyramid Electric Co.	79
Rad-Tel Tube Co.	109
RCA Industrial Electronic Products	90
RCA Institutes	21
RCA Electron Tube Div.	Back Cover
R-Columbia Products Co. Inc.	71
Remington Rand Univac	22
Robt Manufacturing Co.	103
RTS Electronics Div.	13
Sams (Howard W.) & Co. Inc.	82, 83
Schober Organ Co.	80
Sencon	23
Sonotone Corp.	12
Sprague Products Co.	24
Standard Kollsman Industries Inc.	Inside Back Cover
Sylvania Electric Products Inc.	14
TAB	88
Tarzian (Sarkis) Inc.	108
Triplett Electrical Instrument Co.	Inside Front Cover
Tung-Sol Electric Co.	10
Turner Co.	91
University Loudspeakers Inc.	73
Vaco Products Co.	105
Vidair Electronics Manufacturing Corp.	99
Weller Electric Corp.	84
Winegard Co.	95, 97, 99

### SCHOOL DIRECTORY PAGES 106, 107

Baltimore Technical Institute  
Niles Bryant School  
Canadian Institute of Science Technology  
Indiana Technical College  
International Correspondence School  
Middleton Institute of Electronics  
Milwaukee School of Engineering  
Northrop Institute of Technology  
Pacific International College of Arts & Sciences  
Phila. Wireless Technical Institute  
Philco Technological Center  
Tri-State College  
Valparaiso Technical Institute  
Printed in USA

*Standard Made It...*

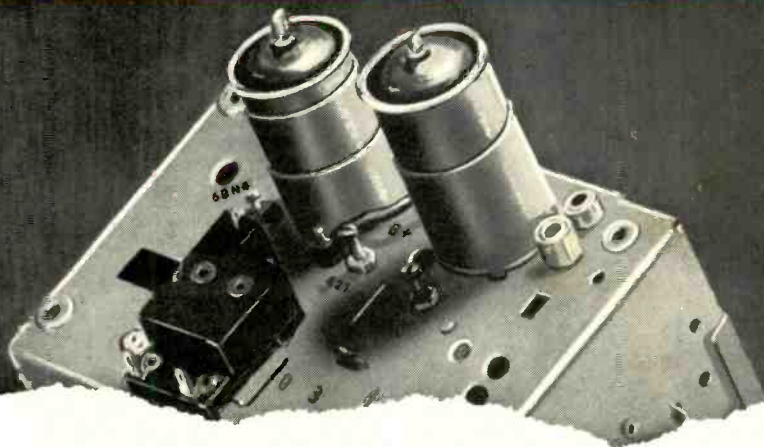

**STANDARD CAN FIX IT BEST**

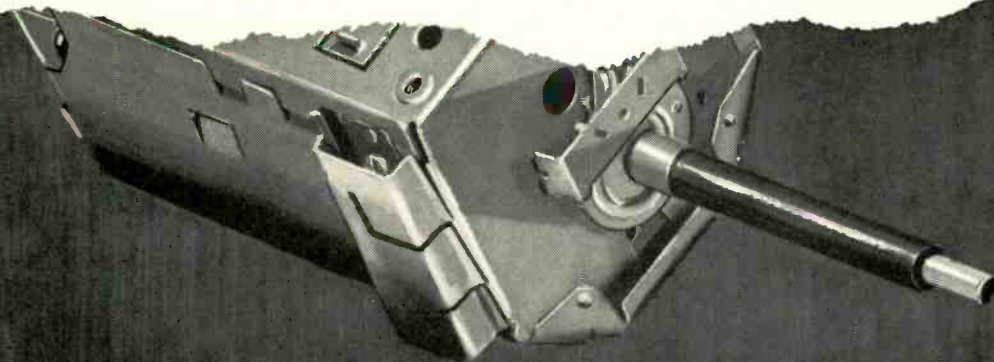

**\$11<sup>50</sup>** Plus Parts . . . **\$13.50 Maximum Total Cost**  
*FREE Specially designed shipping cartons to prevent damage in transit*

**6 Months  
GUARANTEE**

Only BRAND NEW PARTS Used • 48 Hour  
Service on All STANDARD Tuners • Latest  
Testing Techniques Assure Proper Alignment •  
\$3.00 Defective Tuner Trade-in Allowance  
Against a New STANDARD Replacement Tuner  
Carrying a 12 MONTH GUARANTEE

IN TV IT'S *Standard*

STANDARD has maintained uniform mounting centers for the last 13 years. Over 50% of the TV sets in existence today have STANDARD tuners—in the case of most other tuners one of the 8 STANDARD replacement models can be easily adapted or will fit directly in place of these units. All STANDARD replacement tuners carry a 12 Month Guarantee.

**SEE YOUR AUTHORIZED  
STANDARD DISTRIBUTOR**

MORE PROFIT FOR THE SERVICE DEALER • GREATER CUSTOMER SATISFACTION  
GUARANTEED BY THE WORLD'S LARGEST TV TUNER MANUFACTURER

***standard kollman* INDUSTRIES INC.**

FORMERLY STANDARD COIL PRODUCTS CO., INC., MELROSE PARK, ILLINOIS

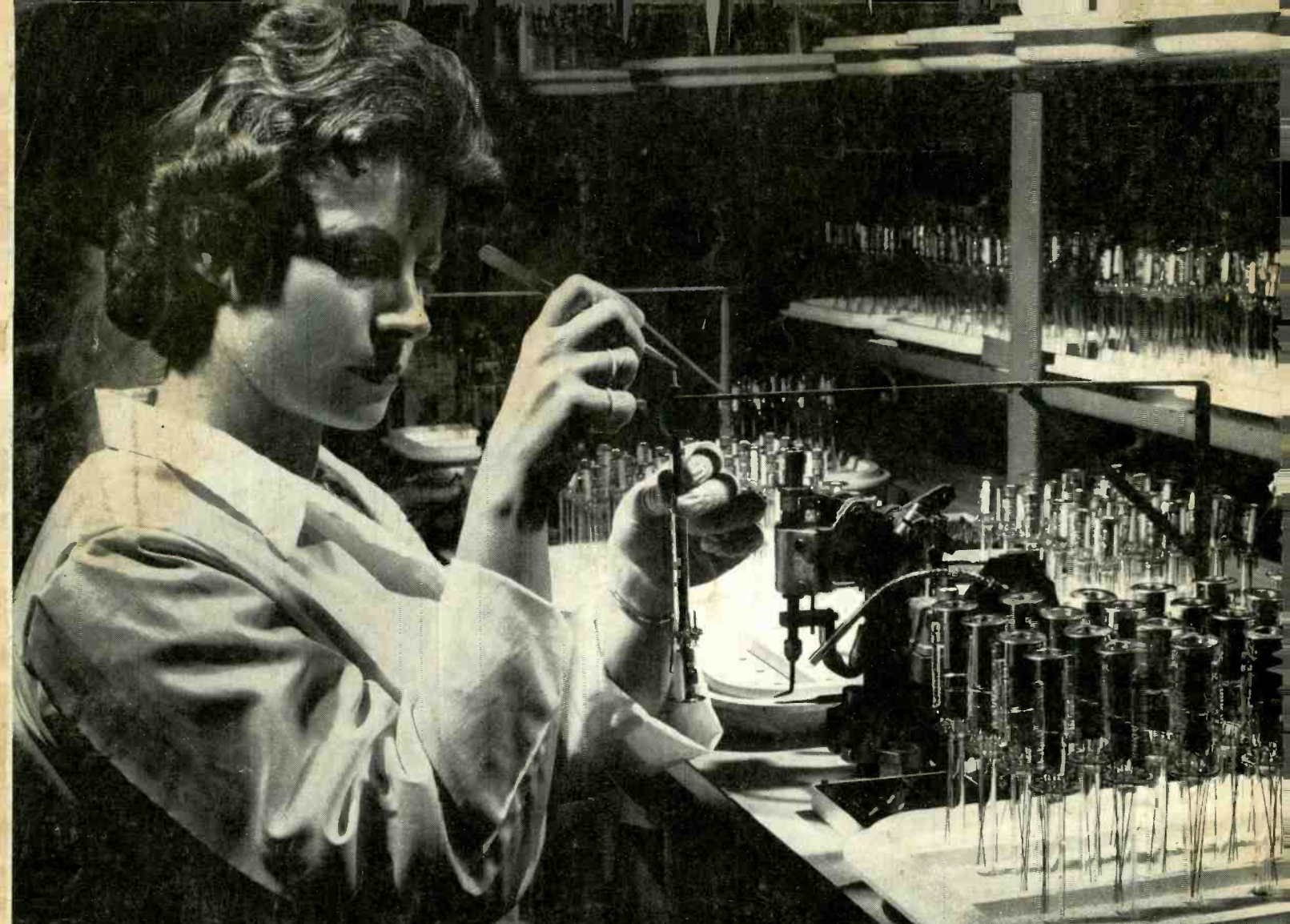

# RCA STICKS TO ITS GUNS

## The life of RCA Picture Tubes depends on it

The electron gun, heart of every TV picture tube, is a precision instrument. A speck of dust in the wrong place can mean the difference between poor and outstanding performance in a picture tube.

RCA assures outstanding performance in Silverama Picture Tubes by assembling every electron gun in the super-clean, dust-free atmosphere of the "White Room" at RCA's modern plant in Marion, Indiana.

Measured in terms of your business—this extra precaution helps to substantially reduce troublesome "in-warranty failures" and costly call-backs. Sell the finest name brand picture tube—RCA Silverama.

Silverama contains all-new electron gun, all-new parts and materials except for the envelope which is used. See your Authorized RCA Distributor today.



Workers wearing lint-free smocks, must enter "White Room" through an airlock. Room is kept under constant pressure to force any air-borne dust out when a door is opened.



Finished guns after ultrasonic cleaning in a super wetting agent are carried to the assembly line in these covered plastic cases—further protection against contamination.



Guns await final assembly in this pressurized plastic housing. Blower at top maintains pressure, prevents dust from entering housing.

RCA ELECTRON TUBE DIVISION, HARRISON, N. J.



The Most Trusted Name in Television  
RADIO CORPORATION OF AMERICA